



slewing rings



production program



Page 4	<b>BASIC INFORMATION</b>	
Page 5	<b>SLEWING RINGS CHARACTERISTICS, APPLICATIONS</b>	
	<b>PSL SLEWING RINGS DESIGNATION</b>	
Page 6	<b>BASIC DESIGN SERIES</b>	
Page 7	<b>QUALITY ASSURANCE</b>	
	<b>SELECTION OF THE SLEWING RING TYPE AND SIZE</b>	
	– Algorithm of working procedures	
Page 8	– Data necessary for selection the suitable slewing ring	
Page 9	– Slewing ring selection with regard to load size	
Page 11	– Dimensioning of the gears	
Page 12	<b>PRESERVATION, PACKAGING, TRANSPORT AND STORAGE</b>	
	<b>MOUNTING OF SLEWING RINGS</b>	
	– Requirements on seating surfaces	
Page 13	– Mounting procedure	
Page 14	– Preload forces and tightening torques	
Page 16	<b>MAINTENANCE OF SLEWING RINGS</b>	
	– Relubrication of the raceways and gears	
	– Slewing ring inspection in operation	
Page 17	– Recommended lubricants	
Page 18	<b>SLEWING RING TABLES</b>	
	– Explanatory notes for the tables and diagrams	
Page 19	– Order of slewing rings in the tables	
Page 20	<b>FOUR-POINT CONTACT BALL SLEWING RINGS</b>	
	– without gear	
Page 30	– with external gear	
Page 44	– with internal gear	
Page 52	<b>CROSSED ROLLER SLEWING RINGS</b>	
	– without gear	
Page 58	– with external gear	
Page 64	– with internal gear	
Page 68	<b>SPECIAL AXIAL-RADIAL ROLLER SLEWING RINGS</b>	
Page 70	<b>STATIC LIMITING LOAD DIAGRAMS</b>	
Page 140	<b>CUSTOMER REQUIREMENTS ON SLEWING RING – FORM</b>	
Page 142	<b>TYPICAL APPLICATIONS INVOLVING PSL SLEWING RINGS</b>	



## BASIC INFORMATION

PSL a. s. is a company that has a longstanding tradition in production of rolling bearings.

At the present time the main areas of the production program are represented by the production of normalized and special rolling bearings, slewing rings, worm drives and bearing rollers.



PSL a. s. has created, implemented and certified a system of quality assurance according to ISO 9001 standard, that spans the entire production process from research and development to servicing and advisory activities.

This publication aims to deliver an integrated picture about the current assortment of PSL slewing rings. It contains a table view of both standard and specialised slewing rings, as well as offers basic technical information; and a manual on how to proceed with the installation plan using the right slewing rings; and instructions on the proper procedures installation and servicing of the slewing rings while in operation.

In the case where you need technical assistance involving a complex solution incorporating PSL slewing rings, it will be provided by the PSL Department of Technical Advisory. In the case where you need specific business information, they will be provided by the PSL Sales Department. All contact information pertaining to these specific PSL entities is available on the back of the cover of this publication.

The contents of this catalog have been carefully evaluated and checked, however due to continued technical developments, PSL reserves the right to make technical changes or amendments without prior notice.



## SLEWING RINGS CHARACTERISTICS, APPLICATIONS

Slewing rings are large-sized bearings which can accommodate a combined load, i.e. axial, radial loads and tilting moment. They are usually provided with holes for fixing bolts; internal, external or no gear; and lubrication holes and seals, which allow a compact and economical arrangement. In addition they often enable the elimination of many components necessary in the classical bearing arrangement.

PSL slewing rings have proven effectiveness in the following applications:

- construction, mobile and tower cranes,
- shovel, digging-wheel excavators,
- revolving grabs and winches,
- graders,
- logging industry machines including feller bunchers,
- loaders, vehicles for waste removal, hydraulic grippers,
- axles and undercarriages,
- assembly and access platforms,
- robots, manipulators and positioners,
- machine tools,
- special equipment (rescue vehicles, aerials, feller bunchers and tunnel machines, drilling equipment, wind turbines and cleaning and bottle filling machines).

Combining compactness, accuracy, smooth operation with relative high rigidity, together with simple mounting and operation reliability are qualities that allow the use of these bearings in all industrial branches.

## PSL SLEWING RINGS DESIGNATION

The sequence and meaning of symbols used in PSL slewing ring designations are as follows:

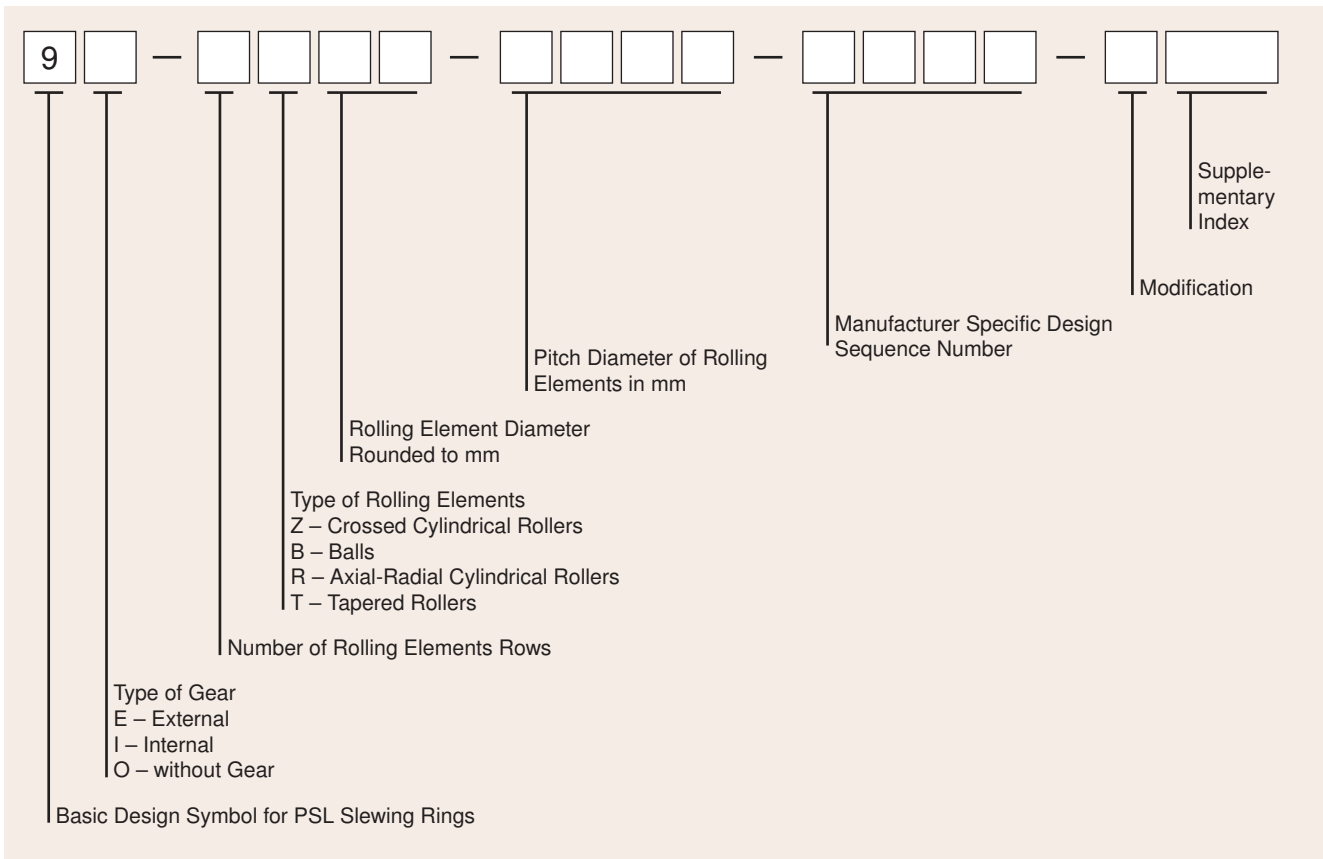

The designation is located on a non-functional surface of the slewing ring. It is made either electrochemically, or by stamping, or marked on a label fastened to the slewing ring.





## BASIC DESIGN SERIES

Single-row four-point contact ball slewing rings and crossed roller slewing rings are being produced in PSL, a.s.

Design type **1B**

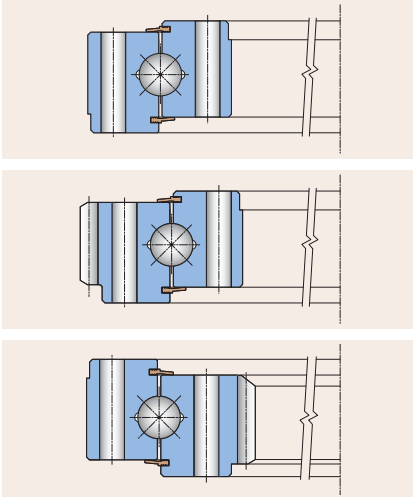

without gear

with external gear

with internal gear

Design type **1Z**

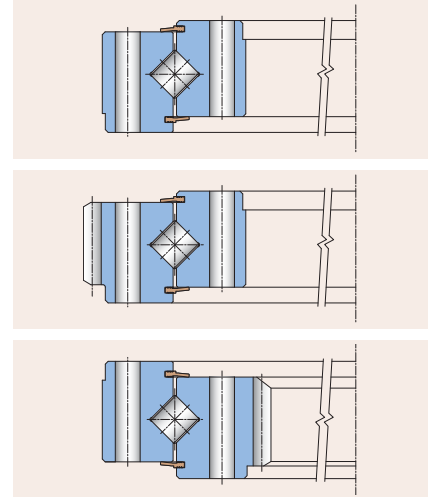

Besides these two main design types of PSL slewing rings, PSL also produces other various slewing rings such as:

- double-row four-point contact ball slewing rings – design type type **2B** (e. g. 9E-2B40-2010-1197)

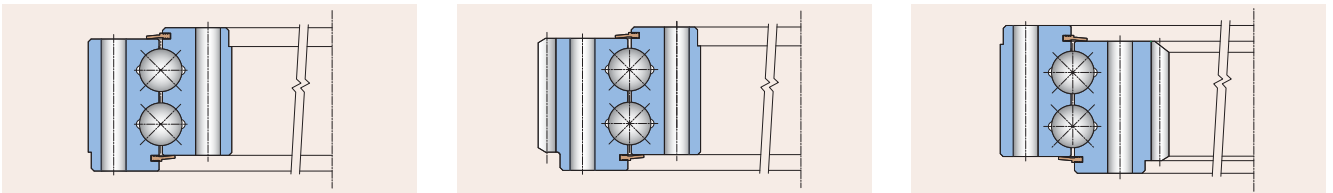

- double-row crossed roller slewing rings – design type **2Z** (e.g. 9O-2Z25-0400-0143)

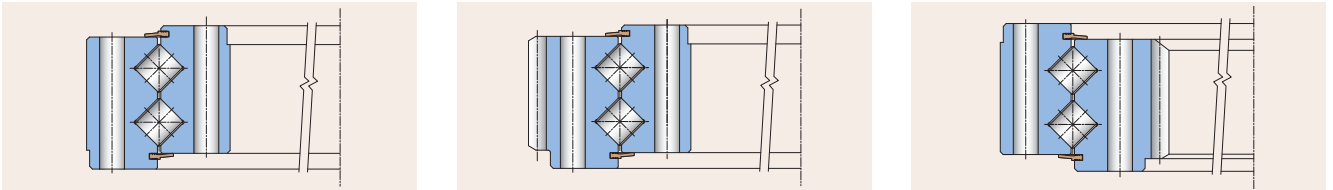

- special double-row axial-radial roller slewing rings – design type 2R (e. g. 9I-2R40-1697-0990)
- special triple-row axial-radial roller slewing rings – design type 3R (e. g. 9I-3R32-2048-1154)

Design type **2R**

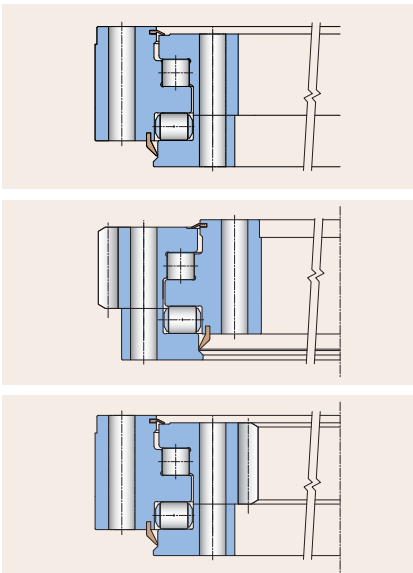

without gear

with external gear

with internal gear

Design type **3R**

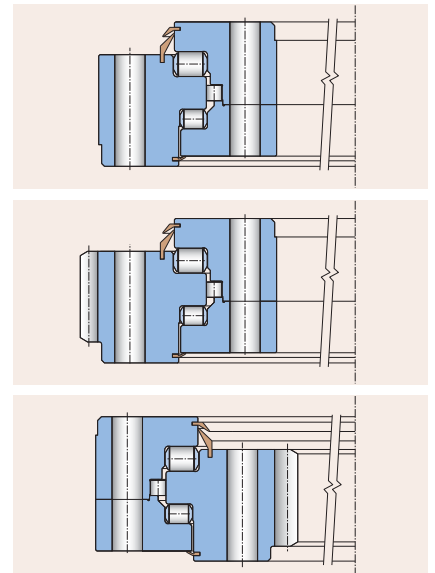

## QUALITY ASSURANCE

In a complex manner, production quality is systematically ensured with the goal to always meet the customers needs during all phases of the manufacturing process.

### **Pre-production phase:**

- pre-sales service – professional services for customers
- marketing – market research from the technical and commercial point of view, monitoring of development trends.

### **Production phase:**

- modern manufacturing methods, tools and procedures
- new materials and methods of heat-treatment
- continuous innovation of the inspection means and methods
- product testing on specialized test beds
- continuous improvement through TQM.

### **Post-production phase:**

- testing of bearing quality in operation; gathered experience is utilized for further performance improvement
- after-sales service – help by specifying application of the products.

## SELECTION OF THE SLEWING RING TYPE AND SIZE

### Algorithm of working procedures

The algorithm of working procedures necessary to follow during the selection of the appropriate application is as follows:

#### **Establishing and summarizing of input data:**

- machine characteristics - required life
- space for assembling
- size, direction and character of loads
- characteristics of operating mode
- characteristics of working environment.

#### **Input data analysis – listing of individual requirements priorities:**

- priority listing of important criteria by which the arrangement will be evaluated
- calculation for structure rigidity.

#### **Selection of suitable slewing ring type and size according to stated criteria:**

- calculation of raceways, gear and bolts
- analysis of calculation results influencing decision on recommended type and size of slewing ring according to criterion priorities.

#### **Complex arrangement proposal including abutment parts:**

- abutment parts design optimization
- fixing arrangement
- instructions for maintenance.

The algorithm shown above represents a great volume of technically complex information. We advise our customers to seek the advice of the PSL specialists in the Technical Advisory Department when selecting the most suitable bearing. With many years of experience, together with modern specialized computer software, realistic and effecting solutions can be offered by PSL.

A form for assignment data required for slewing ring calculation and selection is in the appendix of this catalog.

The calculation enables us to determine the optimum clearance or preload for the given arrangement with regard to static safety ( $s_0$ ), size of deformation both in radial and axial direction ( $\delta_r$ ,  $\delta_a$ ), and life ( $L_n$ ).

## Data necessary for selection the suitable slewing ring

To recommend a specific size and design of the slewing ring, it is necessary to know the following data:

- size, direction and time shares at the specific operating loads
- required life
- operating rotational speed (number of rotations per time unit)
- requirements on accuracy (smoothness of operation and arrangement rigidity)
- requirements on bearing fixing
- requirements on gear
- characteristics of working environment
- requirements on a built-in space, maximum weight, etc.
- requirements on mounting, dismounting and maintenance of the slewing ring in operation
- requirements on arrangement economy.

This data is at the same time criteria for the evaluation of the slewing ring suitability on any given application. The priority of individual criterion varies and depends on the requirements on the arrangement as a unit.

E. g.:

- excavators – the priority criterion is reliable transmission of the load and life
- turntables of machine tools – the priority criterion is accuracy, smoothness of operation and arrangement rigidity.

In most cases, the slewing rings are used for equipment with cyclic movement, or at relatively low rotational speed. This shows that the main criterion is a reliable transmission of the load (i. e. sufficient capacity of the raceways, gear and fixing bolts).





## Slewing ring selection with regard to load size

Selection of a suitable slewing ring for common applications can be carried out from the point of view of the static load rating by means of the diagrams (curves) for the limiting static load of the raceways and fixing bolts (pages 70 – 139 of this publication) based on the calculated equivalent axial and moment static load.

Slewing rings allow accommodation of combined loads (i.e. both axial and radial forces and tilting moments due to eccentric acting of loads). Typical examples of loading are shown in the following schemes:

Loading – Typical Examples:

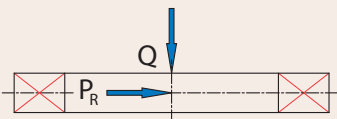
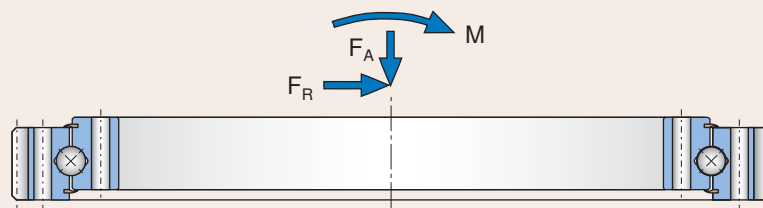

$$\begin{aligned} F_A &= Q \\ F_R &= P_R \\ M &= 0 \end{aligned}$$

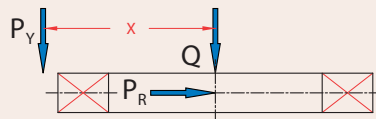

$$\begin{aligned} F_A &= Q \\ F_R &= P_R \\ M &= 0 \end{aligned}$$

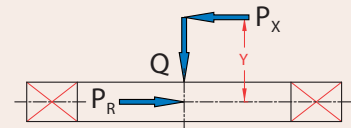

$$\begin{aligned} F_A &= Q \\ F_R &= P_R \\ M &= 0 \end{aligned}$$

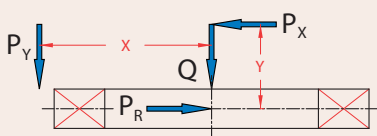

$$\begin{aligned} F_A &= Q + P_Y \\ F_R &= P_X - P_R \\ M &= x \cdot P_Y + y \cdot P_X \end{aligned}$$

$P_X$

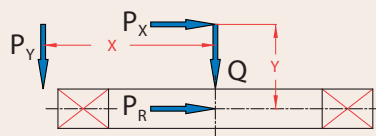

$$\begin{aligned} F_A &= Q + P_Y \\ F_R &= P_X + P_R \\ M &= x \cdot P_Y - y \cdot P_X \end{aligned}$$

$P_X$

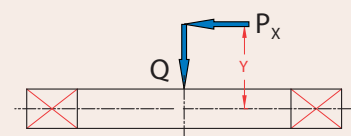

$$\begin{aligned} F_A &= Q + P_Y \\ F_R &= P_X \\ M &= y \cdot P_X \end{aligned}$$

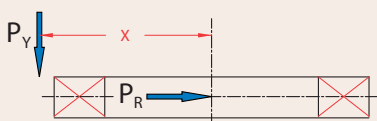

$$\begin{aligned} F_A &= P_Y \\ F_R &= P_R \\ M &= x \cdot P_Y \end{aligned}$$

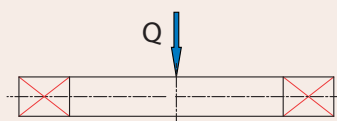

$$\begin{aligned} F_A &= Q \\ F_R &= 0 \\ M &= 0 \end{aligned}$$



$$\begin{aligned} F_A &= 0 \\ F_R &= P_R \\ M &= 0 \end{aligned}$$

Calculation of Equivalent Axial and Moment Static Load		
Slewing Rings	Formula	Conditions of Validity
Four - point contact ball slewing rings	$F'_{OA} = (F_{OA} + 5,05 \cdot F_{OR}) \cdot s_o$ $M'_{OK} = M_{OK} \cdot s_o$	$0,1 < \frac{F_{OR}}{F_{OA}} < 8$ $e > 2$
	$F'_{OA} = (1,23 \cdot F_{OA} + 2,68 \cdot F_{OR}) \cdot s_o$ $M'_{OK} = 1,23 \cdot M_{OK} \cdot s_o$	$0,1 < \frac{F_{OR}}{F_{OA}} < 8$ $e \leq 2$
Crossed roller slewing rings	$F'_{OA} = (F_{OA} + 2,05 \cdot F_{OR}) \cdot s_o$ $M'_{OK} = M_{OK} \cdot s_o$	$0,1 < \frac{F_{OR}}{F_{OA}} < 8$

$F_{OA}$  –  $\Sigma$  of axial static forces for a slewing ring [kN]  
 $F_{OR}$  –  $\Sigma$  of radial static forces for a slewing ring [kN]  
 $M_{OK}$  –  $\Sigma$  of tilting moments (static) for a slewing ring [kNm]  
 $s_o$  – coefficient of static safety (values – see Table 1) [-]  
 $e = \frac{2000 \cdot M_{OK}}{F_{OA} \cdot D_s}$  – parameter of load eccentricity [-]  
 $D_s$  – slewing ring mean diameter [mm]

Note: if  $\frac{F_{OR}}{F_{OA}} < 0,1$  it is not necessary to take into account the radial force when calculating the equivalent load.

The calculated values of the axial and moment static load define the coordinates of the working point in the diagram for the limiting static load of the slewing ring. The working point must lie under the curve for the bolt static load.

Table 1

Values of Static Safety Coefficients for Various Operating Conditions and Applications			
Slewing Ring Movement	Kind of Load Requirements on Movement	Example	$s_o$
Rotary	Uniform load Quiet operation without impacts	• Turntables of the conveyer systems	0.5 – 1.0
	Normal operating conditions Light impacts	• Cleaning and bottle filling machines • Barking machines • Machine tools	1.0 – 1.25
	Great or considerable impact load	• Transport means • Vibration rollers • Radar aerials	1.25 – 1.5
Swinging	Great swing angle with low frequency Uniform load without impacts	• Positioners • Stackers • Assembly cranes • Service cranes	0.8 – 1.1
	Medium swing angle Normal load, light impacts	• Small and medium excavators • Car cranes • Building and ship cranes • Radar aerials • Robots and manipulators	1.25 – 1.5
	Small up to medium swing angle with high frequency Great or considerable impact load	• Cranes with grab or magnet • Transfer cranes • Large excavators • Connecting joints of undercarriages of building, earth and felling machines	1.5 – 2.5
Occasional turning or slewing	Uniform load	• Mounting fixtures • Positioners	0.5 – 0.8
	Normal load Light impacts	• Discharging conveyers • Aerials • Pan slewing rings	1.25 – 1.5
	Great or considerable impact load	• Wind turbines • Concrete pumps • Manipulators for nuclear power stations	1.5 – 2.5

## Dimensioning of the gears

For correct gear dimensioning, it is necessary to know the following data:

- characteristics of the operating conditions, time share of individual work regimes, method of lubrication, operating temperature, etc.
- nominal and maximum circumferential forces by individual working regimes,
- data about pinion (number of teeth, correction, material, heat treatment, etc.).

Suitability for a given application from the point of view of gear dimensioning can be evaluated by comparing the real nominal and maximal circumferential forces with allowed circumferential forces for the gear. Allowed nominal and maximal circumferential forces – Slewing Ring Tables.

Calculation of the nominal and maximum circumferential force:

$$F_{Tnom} = \frac{2000 \cdot M_{Tnom}}{m \cdot (z + 2x)} \quad F_{Tmax} = \frac{2000 \cdot M_{Tmax}}{m \cdot (z + 2x)}$$

Where: $F_{Tnom}$	– nominal circumferential force	[kN]
$F_{Tmax}$	– maximal circumferential force	[kN]
$M_{Tnom}$	– nominal rotating torque	[kNm]
$M_{Tmax}$	– maximal rotating torque	[kNm]
$m$	– gear module	[mm]
$z$	– number of teeth	[–]
$x$	– unit displacement of the basic profile (unit correction)	[–]

The main criteria for evaluating gear suitability is the fatigue resistance at bending and max. static load transmission. The following conditions must be fulfilled:

$$F_{Tnom} \leq F_{TDov} \quad \text{– for fatigue resistance at bending}$$

$$F_{Tmax} \leq F_{TmaxDov} \quad \text{– for max. static load transmission}$$

Permitted values of the nominal and maximum circumferential forces for the PSL slewing ring gear are shown in the Slewing Ring Tables. They were calculated for specific materials from which the individual geared rings are produced.

If the PSL slewing ring cannot be selected according to the above mentioned criteria, contact the experts of the PSL Department of Technical Advisory.





## PRESERVATION, PACKAGING, TRANSPORT AND STORAGE

Before packaging the slewing rings, they are preserved with a liquid preservation agent providing protection against corrosion for approximately 12 months in a temperature controlled environment. The store temperature should be  $20 \pm 5$  °C with relative humidity max. 60 %. After the preserving agent has been applied the slewing rings are wrapped with PE foil band, then packed on pallets or in boxes. The type of packaging should be discussed in advance with PSL, a. s. Slewing rings should be transported horizontally on a pallet if possible, sufficiently secured to prevent movement. Large sized bearings can be also transported on appropriate A-frames in slope position providing they are strengthened against distortion by appropriate struts.

## MOUNTING OF SLEWING RINGS

### Requirements on seating surfaces

Seating surfaces of the connecting structure for slewing rings must meet the following conditions:

- Machining roughness max.  $R_a = 12.6$  (usually  $R_a = 6.3$  or less),
- Acceptable deviation of flatness in both circumferential and radial direction should be equal to a maximum value of:  
 $a = 0.0001 \cdot D_s$  [mm],
- Maximum deflection of connecting structure under maximum operating load should not exceed value of:  
 $y = 0.0005 \cdot D_s$  [mm],

Where:  $D_s$  – slewing ring mean diameter [mm].

The variation of flatness can occur only once within the 180° section. To prevent local bearing overloading due to seating surface out of flatness or deflection of the connecting structure, any possible variation within the section 0° - 90° - 180° should increase or decrease gradually.

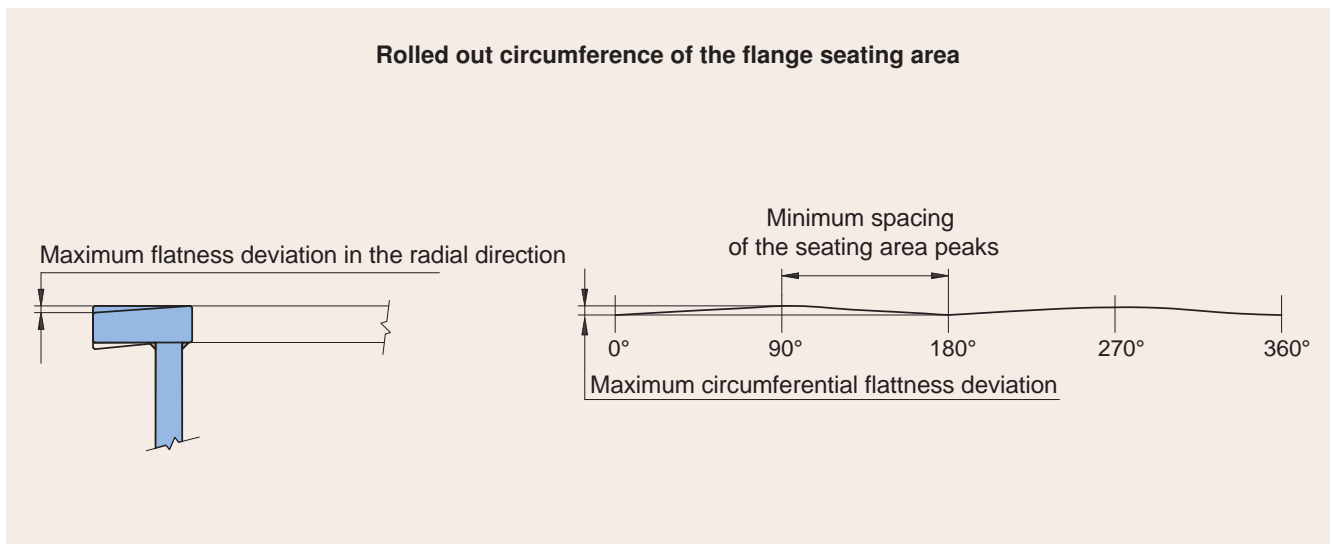

## Mounting procedure

Before assembling, it is necessary to clean all surfaces thoroughly from burrs, paint residues, etc. Seating surfaces should be dry, without lubricant. Furthermore, it is necessary to inspect flatness of the seating surfaces. Feeler gauges are used to check slewing ring adaptation.

The unhardened area of the non rotating ring should be mounted so that it is positioned in the least loaded zone – i.e. in the plane perpendicular to the main load plane. The unhardened area is marked on the respective ring non-functional surface with a stamped symbol “X” or with a painted red line.

When assembling a geared slewing ring, it is important to adjust the backlash in the gear correctly. It is adjusted with a feeler gauge or with another suitable method in the zone of maximum radial gear runout. The extent of the backlash should be approximately  $0.03 \times m$ , where “m” means the gear module. The backlash should be inspected again after the slewing ring is finally fixed on the machine. The zone of the maximum radial gear runout is marked with a blue line in the gap between teeth.

Slewing rings are fixed to the machine with pre-stressed bolts. Before assembly, the fixing bolts should be coated slightly with oil. The size of preload force or tightening moments has to be determined depending on the friction conditions in the bolt thread and on the seating surfaces of the nut (screws and nuts with treated surfaces have a different friction coefficient than ones without surface treatment). Preload forces and needed tightening torques for the particular material and size of the screws without surface treatment (friction coefficient = 0,14 ) are listed in the tables that follow.

The slewing ring should not be loaded by the tilting moment during the process of bolt tightening. Tightening of each of the bolt connections should be divided into two stages until achieving the working size of the preload force or torque. During the first step it is recommended to tighten the bolts until achieving 60 % of the preload force or torque. During the second stage to tighten all the bolts to reach 100 % of the preload force or torque. In each stage of tightening, a sequence as shown in the diagram should be followed.

After finishing the installation of the slewing ring, it is necessary to check the lubrication of all functional parts of the slewing

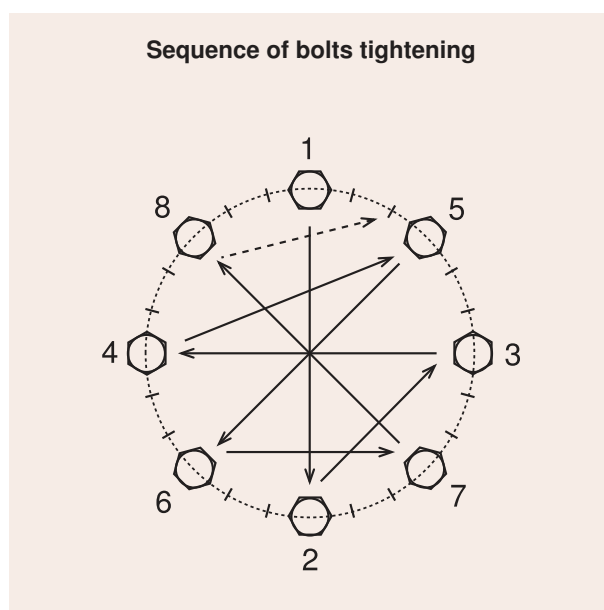

ring and measure the initial tilting clearance of the slewing ring. Tilting clearance is defined as the difference of axial shifts of the rotating part of the construction to the base, while loaded the slewing ring with the tilting moment  $\pm M_{\text{tilting}}$ . Measured values should be recorded in the operation log of the mechanism and should serve in order to evaluate the wear of the raceways.

## Preload forces and tightening torques

Table 2

Preload Forces and Tightening Torques for Metric Bolts (Friction Coefficient $\mu = 0.14$ )								
Strength Class of the Bolt according to DIN/ISO 898			8.8		10.9		12.9	
Yield Strength $R_{p0.2}$ [MPa]			640 for $\leq M 16$ 660 for $> M 16$		940		1100	
Bolt Size according to DIN 13	Pre-loaded Cross-Section	Thread Cross-Section	Preload Force	Tightening Torque	Preload Force	Tightening Torque	Preload Force	Tightening Torque
	$A_s$ [mm <sup>2</sup> ]	$Ad_3$ [mm <sup>2</sup> ]	$F_M$ [N]	$M_U$ [Nm]	$F_M$ [N]	$M_U$ [Nm]	$F_M$ [N]	$M_U$ [Nm]
M 5	14.2	12.7	6,400	5.5	9,300	8.0	10,900	9.3
M 6	20.1	17.9	9,000	9.3	13,200	13.9	15,400	16.2
M 8	36.6	32.8	16,500	22.5	24,200	33	28,500	38
M 10	58	52.3	26,000	45	38,500	67	45,000	78
M 12	84.3	76.2	38,500	78	56,000	117	66,000	135
M 14	115	105	53,000	126	77,000	184	90,000	216
M 16	157	144	72,000	193	106,000	279	124,000	333
M 18	193	175	91,000	270	129,000	387	151,000	459
M 20	245	225	117,000	387	166,000	558	194,000	648
M 22	303	282	146,000	522	208,000	747	243,000	873
M 24	353	324	168,000	666	239,000	954	280,000	1,116
M 27	459	427	221,000	990	315,000	1,395	370,000	1,665
M 30	561	519	270,000	1,350	385,000	1,890	450,000	2,250
M 33	694	647	335,000	See note	480,000	See note	560,000	See note
M 36	817	759	395,000		560,000			
M 39	976	913	475,000		670,000			
M 42	1,120	1,045	542,000		772,000			
M 45	1,300	1,224	635,000		905,000			
M 48	1,470	1,377	714,000		1,018,000			
M 52	1,760	1,652	857,000		1,221,000			
M 56	2,030	1,905	989,000		1,408,000			
M 60	2,360	2,227	1,156,000		1,647,000			

**Note:**

Tightening torques shown in Tables 2 and 3 are valid for tightening with a torque wrench. The permissible variance is  $\pm 10\%$  of values shown in the tables. When using bolts with thread greater than M30, the friction size is substantially different. It is not recommended to create the required preload by a torque wrench, but by means of a hydraulic tensioning device. In this case the preload should be adjusted by means of measuring the whole bolt prolongation.

The overall bolt prolongation is:

$$\Delta l = F_M \cdot \delta_s \text{ [mm]},$$

where:  $\delta_s$  – Yielding of bolt and nut.



Table 3

Preload Forces and Tightening Torques for Bolts with UNC Standard Thread (Friction Coefficient $\mu = 0.14$ )						
Strength Class of the Bolt according to ASTM			A-325 (Grade 5)		A-490 (Grade 8)	
Bolt Size according to ANSI B 1.1	Pre-loaded Cross-Section $A_S$ [sq.in]	Thread Cross-Section $A_d$ [sq.in]	Preload Force $F_M$ [lbs]	Tightening Torque $M_U$ [ft.lbs]	Preload Force $F_M$ [lbs]	Tightening Torque $M_U$ [ft.lbs]
1/4 – 20	0.0318	0.0269	1,893	7	2,896	10
5/16 – 18	0.0524	0.0453	3,120	14	4,771	21
3/8 – 16	0.0775	0.0678	4,611	25	7,052	38
7/16 – 14	0.1063	0.0933	6,325	39	9,674	60
1/2 – 13	0.1419	0.1257	8,443	60	12,913	92
9/16 – 12	0.1819	0.1620	10,826	87	16,557	133
5/8 – 11	0.2260	0.2017	13,447	120	20,566	183
3/4 – 10	0.3345	0.3019	19,900	213	30,436	325
7/8 – 9	0.4617	0.4192	25,211	314	42,018	524
1 – 8	0.6057	0.5509	33,074	471	55,123	786
1 1/8 – 7	0.7633	0.6929	41,675	668	69,458	1,113
1 1/4 – 7	0.9691	0.8896	50,200	894	88,189	1,571
1 3/8 – 6	1.1511	1.0502	59,626	See note	104,748	See note
1 1/2 – 6	1.4053	1.2935	72,792		127,878	
1 3/4 – 5	1.8995	1.7437	98,392		172,851	
2 – 4 1/2	2.4982	2.2996	129,408		227,339	
2 1/4 – 4 1/2	3.2477	3.0206	168,230		295,540	
2 1/2 – 4	3.9988	3.7154	207,139		363,893	

1 sq.in = 645.16 mm<sup>2</sup>  
1 mm<sup>2</sup> = 1.5500031 · 10<sup>-3</sup> sq.in

1 lbs = 4.448222 N  
1 N = 0.22480892 lbs

1 ft.lbs = 1.355818 Nm  
1 Nm = 0.73756209 ft.lbs

It is necessary to use hardened washers for the friction joints according to DIN 6916 / EN14399-6 standards with hardness 295 – 350 HV beneath the bolt heads. The washers are used to distribute the strain onto the largest surface possible so that the value of the specific load of the seating surface under the bolt head and nut doesn't exceed allowed values. The assembly preload force value in the bolts should be high enough to ensure that the bolts don't become loose.

We recommend washers of the Nord-Lock type for dynamic cyclic stressed applications of the involved threaded joints.



## MAINTENANCE OF SLEWING RINGS

Maintenance involves a regular relubrication of the raceways and gear, together with the inspection of fastened bolts and the wear of the bearing.

### Relubrication of the raceways and gears

Generally recommended lubricants for the raceways are lithium plastic lubricants with the consistency level of 2 with EP additives. For the gears, plastic lubricants for open gears are recommended. The overview of recommended lubricants is shown in Table 4.

Relubrication interval and lubricant quantity primarily depends on operating conditions, i.e. load, rotational speed, operational environment properties, etc. For low-speed applications (mobile cranes, construction cranes, etc.), the relubrication interval is about 200 operating hours. For machines with higher rotational speed; for equipment operating under permanent rotational speed; or for equipment in tropical conditions (excavators, universal finishing machines, magnetic separators, etc.), the relubrication interval is shorter, approximately 70-100 operating hours.

The quantity of necessary grease for each relubrication can be approximately calculated using the following formula:

$$Q_m = 0,3 \cdot D_s^2 \quad [\text{kg}]$$

Where:  $D_s$  – slewing ring mean diameter [m]

When relubricating, the lubricant should be uniformly distributed in the inner space of the slewing ring. The most suitable way of achieving this is to apply the lubricant while the bearing rotates or by application from several circumferential positions of the slewing ring.

### Slewing ring inspection in operation

It is possible to evaluate the level of wear of the raceways and rolling elements according to the inspection of the run smoothness of the slewing ring and by measuring and evaluating the size of tilting clearance.

Wear of the gear can be measured through regular dimensional inspection of the teeth thickness.

The inspection of the bolt joints consists of the examination of the tightening of the bolts (conducted with the torque wrench) and checking the technical condition of the bolts focusing on possible cracks in the bolts as well as on determining the existence of depth corrosion. During each inspection each obviously loosed bolt is being retightened according to the assembly instruction. Bolts with cracks or heavily corroded have to be replaced by new ones.

Control of the seals is conducted through determining the functionality and the integrity of the seals.

More detailed information about the inspection of slewing rings in operation will be provided upon request by the specialists of the PSL Technical Advisory Department.

## Recommended lubricants

Table 4

Producer	Lubricant type	
	Raceway	Gear
	Aralub HLP 2 (-30 °C to +120 °C) (243 K to 393 K)	Aralub MKA - Z 1 (-20 °C to +200 °C) (253 K to 473 K)
	Energrease LS - EP 2 (-25 °C to +140 °C) (248 K to 413 K)	Energrease LC 2 (-30 °C to +150 °C) (243 K to 423 K)
	Spheerol EPL 2 (-20 °C to +140 °C) (253 K to 413 K)	Castrol LZV - EP (-30 °C to 150 °C) (243 K to 423 K)
	Epexa 2 (-20 °C to +140 °C) (253 K to 413 K)	Cardrexa DC 1 (-20 °C to +120 °C) (253 K to 393 K)
	Beacon EP 2 (-20° C to +110 °C) (253 K to 383 K)	Multi purpose grease (Moly) (-25 °C to +150 °C) (248 K to 423 K)
	Ronex MP (-25 °C to +130 °C) (248 K to 403 K)	Dynagear (-20° C to +100 °C) (253 K to 373 K)
	Lagermeister EP 2 (-20 °C to +130 °C) (253 K to 403 K)	Ceplattyn 300 (-30 °C to +250 °C) (243 K to 523 K)
	Klüberlub BE 41-542 (-20 °C to +140 °C) (253 K to 413 K)	Grafloscon C-SG 0 Ultra (-30 °C to +200 °C) (243 K to 473 K)
	Mobilux EP 2 (-25 °C to +120 °C) (248 K to 393 K)	Mobilgear OGL 461 (-20 °C to +120 °C) (253 K to 393 K)
	Shell Alvania EP 2 (-25 °C to +130 °C) (248 K to 403 K)	Shell Malleus OGH (-20 °C to +130 °C) (253 K to 403 K)
	Multifak EP 2 (-30 °C to +120 °C) (243 K to 393 K)	Crater 2x Fluid or 5x Fluid (-12 °C to +116 °C) (261 K to 389 K)
	Multis EP 2 (-30 °C to +150 °C) (243 K to 423 K)	Total Cardrexa GR 1 - AL (-30 °C to +120 °C) (243 K to 393 K)
	Unoba EP 2 (-18 °C to +143 °C) (255 K to 416 K)	Gearite HD CF 4800 (12 °C to +120 °C) (285 K to 393 K)

## SLEWING RING TABLES

### Explanatory notes for the tables and diagrams

The following tables show the **standard PSL slewing rings** whose cross-section corresponds to the figure above the Table. The tables contain basic dimensional specifications as well as data for the attachment and other technical specifications.

The load curves for individual standard slewing rings have been calculated for the static safety factor of  $s_0 = 1$  and are listed based on the PSL specific design sequence number.

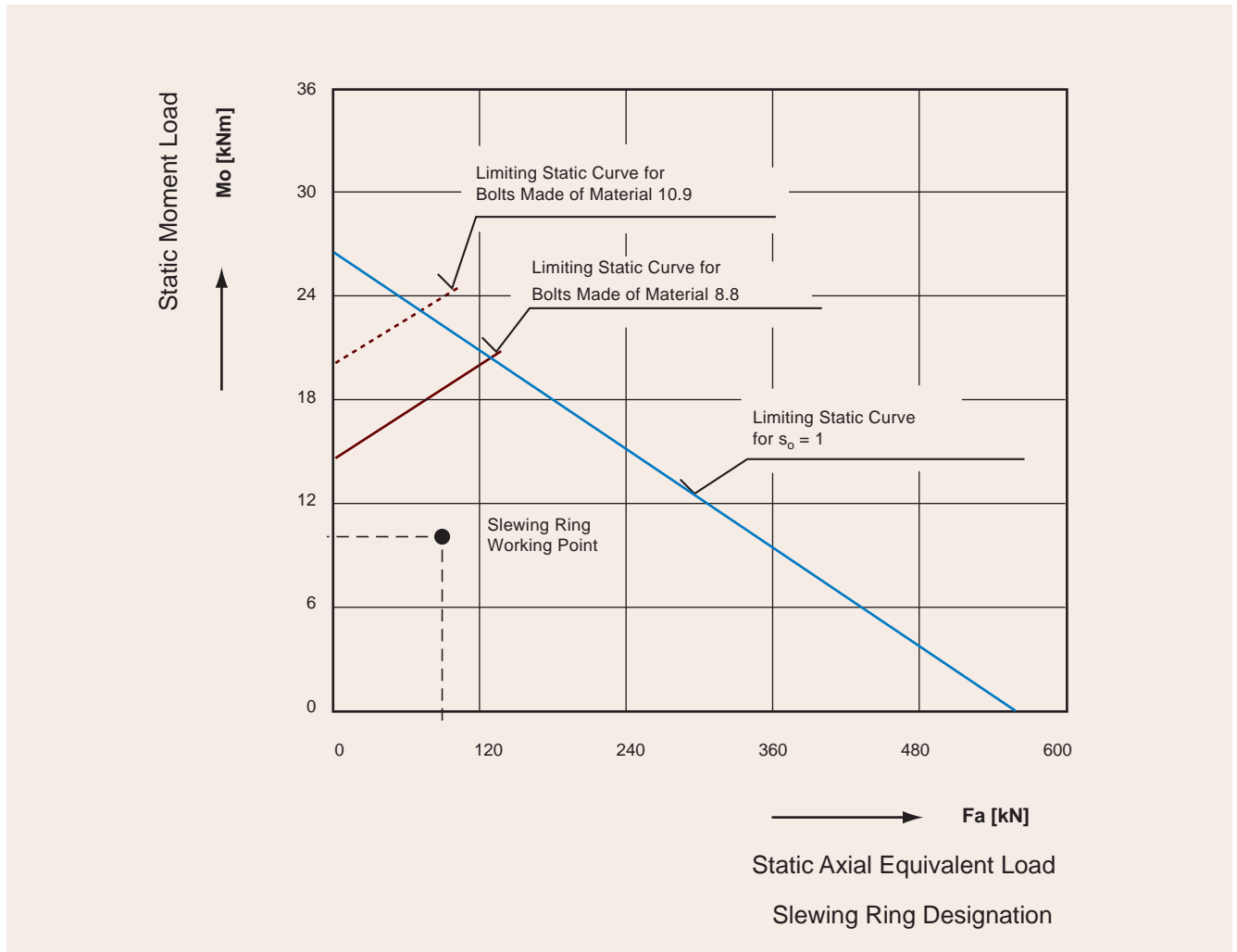

The following conditions apply to the static limiting load curves of bolts:

- The bolts are uniformly spaced around the circumference of the bolt pitch circles
- The axial load acts on the slewing ring in a “seating way”, i.e. the bolts are not sufficiently loaded by the “hanging” load
- The size of the radial load is maximum 10% of the axial bearing load
- The slewing ring and fitting construction are made of steel
- The design of the attached parts is rigid enough, the fitting surface are machined
- The gradient of the bolt head or nut seating surface to the bolt axis is max.  $1^\circ$
- The clamping length is minimally  $l_k = 5 \cdot d$
- The friction coefficient in the thread is 0.14

Note:

If there is great radial load, the bolt hole diameter should be as large as possible and the slewing ring should be radially supported, i.e. piloted in an adjacent construction.

If the corresponding diagram lacks either one or both of the curves for the bolts, then those bolts are overdimensioned with regards to raceways.

**Special PSL slewing rings** – i. e. slewing rings that have cross sections which do not correspond with the pictures above the tables or otherwise deviate from the standard production (e. g. have irregular distribution of mounting holes, special gears, higher accuracy, not sealed from one or both sides or have an atypical shape of rings). These slewing rings have listed their boundary dimensions, designation and weight only.

Technical help with choosing the right slewing ring and additional information about the particular application will be provided upon request by the personnel of the PSL Technical Advisory Department. If needed, please fill in the data questionnaire that is located at the back of this publication.

## Order of slewing rings in the tables

Slewing ring types located in the tables are listed in the following order:

Four-point contact ball slewing rings:

- without gear
- with outer gear
- with inner gear

Crossed roller slewing rings:

- without gear
- with outer gear
- with inner gear

Special axial-radial roller slewing rings



## FOUR-POINT CONTACT BALL SLEWING RINGS – without gear

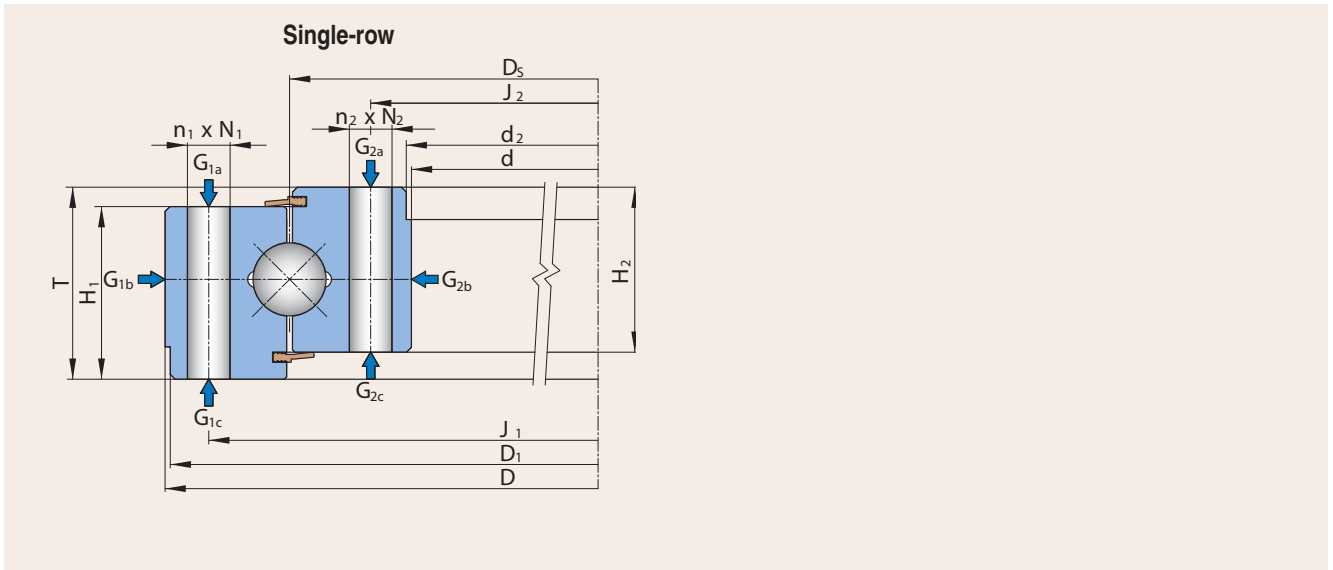

### Single-row

Boundary Dimensions			Designation	Weight	Abutment Dimensions				Mounting Holes $N_1$		Mounting Holes $N_2$	
d	D	T			G	$J_1$	$J_2$	$N_1$	$N_2$	Number $n_1$	Hole Type	Number $n_2$
[mm]			[kg]	[mm]								
101.6	223.7	49	90-1B22-0163-1038	9.4	203.200	120.65	M10	M10	16	D	(20-1)	D
101.6	228.6	49	90-1B20-0163-0650	10	205.308	120.7	11	3/8-16 UNC	8	B	8	D
125	234	25	90-1B10-0179-0670	4	214	144.5	9	9	24	B	(20-1)	B
126	259	43.95	90-1B14-0193-0850-1	9	232	153	M16	17	12	C	12	A
130	240	30	90-1B17-0183-1125	9	220	150	M10	M10	8	C	8	C
140	300	36	90-1B13-0220-1092	11.5	270	170	M16	18	12	C	12	A
140	300	36	90-1B13-0220-0318-1	12	270	170	13	12	13	A	13	C
140	300	36	90-1B13-0220-0318	11	270	170	M16	18	12	C	12	A
145	300	50	90-1B20-0223-0427	16.7	270	175	14.27	14.27	16	A	16	A
145	300	50	90-1B20-0223-0574	15	270	175	M16	M16	16	C	8	C
145	300	50	90-1B20-0223-0447	17	270	175	14.3	1/2-13 UNC	8	B	8	C
145	300	50	90-1B20-0223-0574-1	15	270	175	M16	M16	16	C	8	C
145	300	50	90-1B22-0223-0397	16.5	270	175	5/8-11 UNC	17	16	C	(16-1)	A
145	300	50	90-1B20-0223-0326	15	270	175	17	17	16	A	(16-1)	A
183	375	63	90-1B25-0279-0428	33.5	338	220	M16	M16	12	E	12	E
190	329	45	90-1B22-0260-0884	15	305	215	14	14	16	A	16	A
191	326	46	90-1B20-0260-0851	15	305	215	14	14	20	A	20	A
191	326	46	90-1B20-0260-1187	15	305	215	13.5	13.5	20	A	20	A
200	300	35	90-1B14-0250-0479	8	280	220	M10	M10	16	C	16	C
210	365	40	90-1B20-0289-0295	20	335	240	14	14	16	A	(20-1)	A
210	365	40	90-1B20-0289-0295-1	18	335	240	1/2-13 UNC	1/2-13 UNC	16	C	(20-1)	C
210	365	40	90-1B20-0289-0295-3	20	335	240	14	14	16	A	20	A
210	365	40	90-1B20-0289-0295-4	18	335	240	12.7	12.7	16	A	20	A
210	365	40	90-1B20-0289-0295-5	20	335	240	14	14	16	A	20	A
210	365	40	90-1B20-0289-0295-6	18	335	240	5/8-11 UNC	5/8-11 UNC	16	C	20	C
210	365	40	90-1B20-0289-0295-7	18	335	240	1/2-13 UNC	1/2-13 UNC	16	C	(20-1)	C
232	400	46	90-1B20-0318-0945	24.5	375	259	14	14	16	B	16	B
235	403.5	55	90-1B22-0311-1049	26	358	259	M12	13	24	D	(28-1)	A
265	420	50	90-1B20-0342-0793	26	390	295	14	14	18	A	24	A
267	418	50	90-1B20-0342-0789	25	390	295	14.4	14.4	18	A	24	A
270	486	63	90-1B25-0378-0401	50	442	314	M20	22	16	E	16	A
270	380	35	90-1B14-0325-1067	12.5	360	290	11	1	24	A	24	A
275	485	55	90-1B25-0380-0852	45	453	307	18	18	16	A	16	A
314	457	48	90-1B20-0386-1320	27.5	430	341	15	15	18	A	18	A
323.6	520.29	54.1	90-1B25-0422-0485	46.5	479.425	365.125	5/8-11 UNC	17.5	20	D	20	A



### Mounting holes types

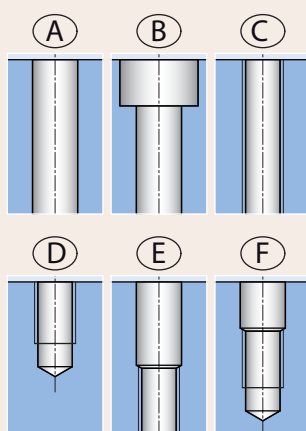

### Lubrication spots types

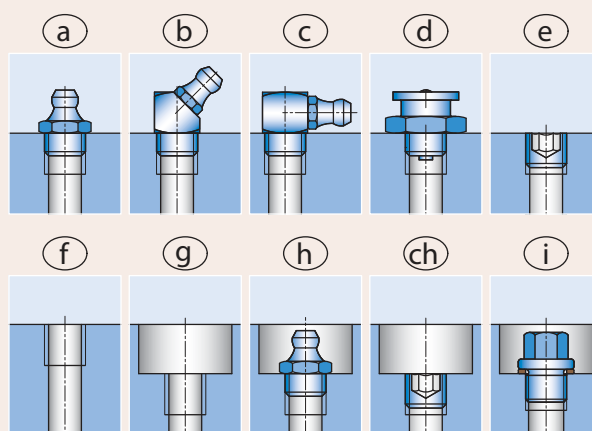

Other Specifications				Lubrication Spots				Note No.	Notes
D <sub>1</sub>	d <sub>2</sub>	H <sub>1</sub>	H <sub>2</sub>	Type	Size	Location	Number		
[mm]									
-	-	43	43	f	1/8-27 NPT	G1c	1		1 - Pilot diameter d <sub>1</sub> is on the opposite side of the inner ring
-	-	43	43	a	1/8-27 NPT	G1b	1		2 - Counterbore of the mounting holes on one (upper) side
-	125	24	24	a	AM8x1	G1b	1	1, 2	3 - Lubricant filling for the total lifetime
259	126	34	34.95	-	-	-	-	3	
240	130	28	28	a	R 1/8"	G1b	2		
-	-	30	30	e	M10x1	G1b	1		
-	-	30	30	f	M10x1	G1b	1		
-	-	30	30	f	M10x1	G1b	1		
-	-	44	44	f	M10x1	G2b	1		
-	-	42	42	f	1/8-27 NPT	G1b	2		
300	146	44	44	f	1/8-27 NPT	G1b	2		
-	-	42	42	f	1/8-27 NPT	G2b	2		
299.24	146	44	44	f	1/8-27 NPT	G1b	2		
300	145	44	44	f	M10x1	G2b	1		
373	185	54	54	f	M10x1	G1b	3		
328	192	44	44	a	AM10x1	G1b	1		
-	-	41	41	h	AM8x1	G1b	1		
-	-	41	41	h	AM8x1	G1b	2		
-	-	30	30	c	CM8x1	G1a	2		
210	365	38	38	f	1/8-27 NPSF	G2b	2		
-	-	38	38	f	1/8-27 NPT	G1b	1		
210	365	38	38	a	AM10x1	G2b	2		
-	-	38	38	e/a	1/8-27 NPT	G1b/G2b	2/2		
-	-	38	38	e/a	1/8-27 NPT	G1b/G2b	2/2		
-	-	38	38	a	1/8-27 NPT	G2b	1		
-	-	38	38	h	1/8-27 NPT	G1b	1		
400	232	41	41	a	AM10x1	G1b	4		
-	-	45	45	f	1/8-27 NPT	G1b	4		
414	270.8	44	44	a	1/8-27 NPT	G1b	1		
418	267	43.6	43.6	a/e	1/8-27 NPT	G1b/G2a	1/1		
456	270	54	54	h	AM10x1	G1b	4		
378	272	30	30	h	AM6	G1b	2		
-	-	50	50	h	AM8x1	G1b	1		
-	-	46	46	h	AM10x1	G1b	2		
-	-	52.3	52.3	a	1/8-27 NPT	G1b	1		

## FOUR-POINT CONTACT BALL SLEWING RINGS – without gear

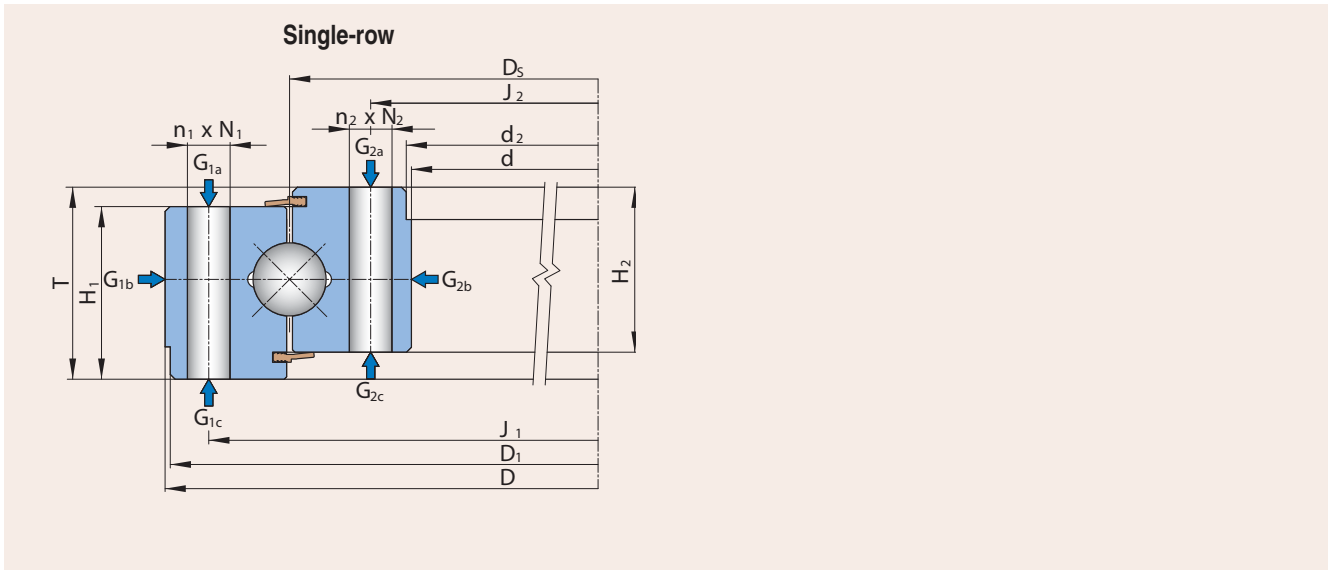

### Single-row

Boundary Dimensions			Designation	Weight G	Abutment Dimensions				Mounting Holes $N_1$		Mounting Holes $N_2$	
d	D	T			$J_1$	$J_2$	$N_1$	$N_2$	Number $n_1$	Hole Type	Number $n_2$	Hole Type
[mm]			[kg]	[mm]								
323.6	520.29	54.1	90-1B25-0422-0485-1	45	479.425	365.125	17.5	17.5	20	A	20	A
323.6	520.2	54.1	90-1B25-0422-1200	47.5	479.425	365.125	17	5/8-11 UNC	20	A	20	D
323.6	520.29	54.1	90-1B25-0422-0513-1	46	479.425	365.125	19	3/4-10 UNC	20	A	16	D
323.6	520.29	54.1	90-1B25-0422-0513-2	46	479.425	365.125	16	3/4-10 UNC	20	A	16	D
323.8	520.3	53.8	90-1B25-0422-0564	46	479.425	365.125	14.3	3/4-10 UNC	20	B	16	D
330	530	85	90-1B35-0430-0537	67	495	365	M16	17	(36-1)	E	36	A
333	558	72	90-1B30-0446-1217	65.5	514	377	22	22	20	A	20	A
336	474	46	90-1B20-0405-0387	25	450	360	14	14	30	A	30	A
336	474	46	90-1B20-0405-0387-1	25	450	360	13	13	24	A	24	A
342	486	56	90-1B20-0414-1087	30	460	368	1/2-13 UNC	14.4	12	F	12	B
384	562	59	90-1B25-0475-0204	40	530	420	18	18	16	A	16	A
400	580	70	90-1B30-0490-0377	57	550	430	M16	17	18	E	18	A
435	721.4	87.3	90-1B45-0559-1350	138	644.5	473.1	20	20	(30-1)	B	30	B
441.5	654	84	90-1B32-0548-1361	92	619.1	476.3	3/4-10 UNC	3/4-10 UNC	30	E	(30-1)	E
450	650	75	90-1B32-0550-0418	69	615	485	22	22	(36-1)	A	36	A
460	600	45	90-1B22-0530-1019	37	575	485	14	14	24	A	24	A
460	699	72	90-1B32-0580-0342	93	655	504	22	22	22	A	22	A
482.6	654.1	57.2	90-1B20-0560-1039	51.5	604.85	515.92	1/2-13 UNC	16	12	D	12	A
487	712	72	90-1B30-0600-1113	90	668	531	22	20	24	A	24	E
517	753	88	90-1B40-0635-0550	110	713	557	23.8	23.8	(36-1)	A	36	A
521.7	779.5	95.3	90-1B45-0654-0614	152	738.175	572.567	20.6	3/4-10 UNC	(36-1)	A	36	D
545	730	68	90-1B25-0640-0355	73	690	580	M12	17.5	24	D	24	A
634	848	56	90-1B20-0744-0341	75	820	662	M18x1.5	M18x1.5	24	C	24	C
675	851	70	90-1B25-0763-0831	83.5	820	705	17	M16	24	A	24	C
726.4	1041.4	98.6	90-1B40-0883-1354	285	990.6	787.4	3/4-10 UNC	21	20	D	20	B
771.7	1133.6	114.3	90-1B50-0953-1299	352	1060.5	844.5	33	33	(40-1)	A	40	A
772	916	56	90-1B20-0844-0565-1	57	890	798	13.5	13.5	40	A	40	A
810	900	40	90-1B13-0854-0313	27	884	826	9	9	24	A	24	A
745	1065	110	90-1B50-0900-0579	290	1000	800	31	31	36	A	36	A
753.1	1010.9	82.6	90-1B35-0867-1122	188	939.8	781.05	17.5	5/8-11 UNC	24	B	24	C
803.1	1016	76.2	90-1B32-0910-0791	140	981.075	838.2	21	3/4-10 UNC	36	A	36	D
957.6	1200	74	90-1B30-1079-0898	176.5	1154	1004	22	22	36	A	36	A
1093	1261	67	90-1B20-1177-0655	132	1231	1123	14	14	24	B	24	B
1040	1360	120	90-1B50-1200-1239	430	1300	1100	30	30	40	A	40	A
1184.6	1271.98	65	90-1B14-1229-0657	62	1256	1202	M10	M10	36	D	36	D

### Mounting holes types

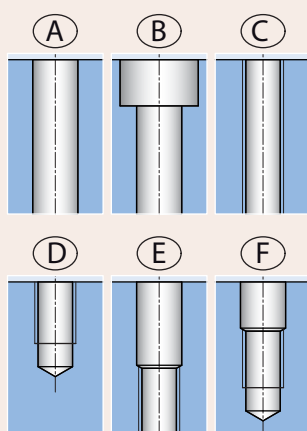

### Lubrication spots types

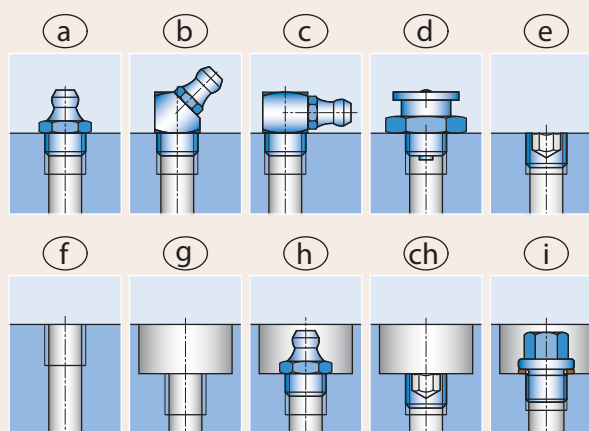

Other Specifications				Lubrication Spots				Note No.	Notes
D <sub>1</sub>	d <sub>2</sub>	H <sub>1</sub>	H <sub>2</sub>	Type	Size	Location	Number		
[mm]									
-	-	52.3	52.3	a	1/8-27 NPT	G1b	4		1 - Pilot diameter d <sub>1</sub> is on the opposite side of the inner ring
-	-	52.3	52.3	a	1/8-27 NPT	G1b	4		2 - Counterbore of the mounting holes on one (upper) side
-	323.6	52.3	52.3	a	1/8-27 NPT	G1b	1		3 - Lubricant filling for the total lifetime
-	323.6	52.3	52.3	a/f	1/8-27 NPT	G1b/G2b	1/1		
-	-	52.3	52.3	a	1/8-27 NPT	G1b	1		
530	330	76	76	h	AM8x1	G1b	8		
558	333	63	63	h	AM10x1	G1b	4		
-	-	41	41	g	M8x1	G1b	3		
-	-	41	41	g	M8x1	G1b	3		
-	-	44.5	44.5	h	AM6	G1b	2		
560	384	52	52	g	M10x1	G1b	4		
580	400	61	61	g	M10x1	G1b	3		
-	-	81	81	a	1/8-27 NPT	G2b	6		
-	-	74.7	74.7	a	1/8-27 NPT	G1b	2		
-	-	65	65	h	AM10x1	G1b	4		
600	460	45	45	f/f	M10x1	G1b/G2b	2/2		
-	-	63	63	g	M8x1	G1b	8		
-	-	45.7	45.7	a	1/8-27 NPT	G2b	4		
-	-	63	63	h	AM10x1	G1b	3		
753	717	79	79	g	M10x1	G1b	3		
-	-	85.9	85.9	a	1/8-27 NPT	G1b	2		
-	-	59	53	f	M10x1	G1b	3		
-	-	45.5	45.5	g	M10x1	G1b	8		
850	-	55	60	g	M10x1	G1b	2		
-	-	88.9	88.9	f	1/8-27 NPT	G1b	3		
-	-	101.6	101.6	a	1/8-27 NPT	G1b	4		
-	-	44.5	44.5	a	AM8x1	G1b	4		
900	810	33	33	f	M8x1	G1a	3		
-	-	100	100	f	M10x1	G2b	4		
-	-	73.2	73.2	h	1/8-27 NPT	G1b	4		
1012.95	806.45	66.5	66.5	c	1/8-27 NPT	G1b	2		
1199	959	63.5	63.5	f	M10x1	G1b	4	1	
1261	1093	58	58	a	AM10x1	G2b	6		
1355	1045	110	110	a	AM10x1	G1b	4		
-	-	50	50	f	G 1/8" (1/8 BSP)	G1b	4		

## FOUR-POINT CONTACT BALL SLEWING RINGS – without gear

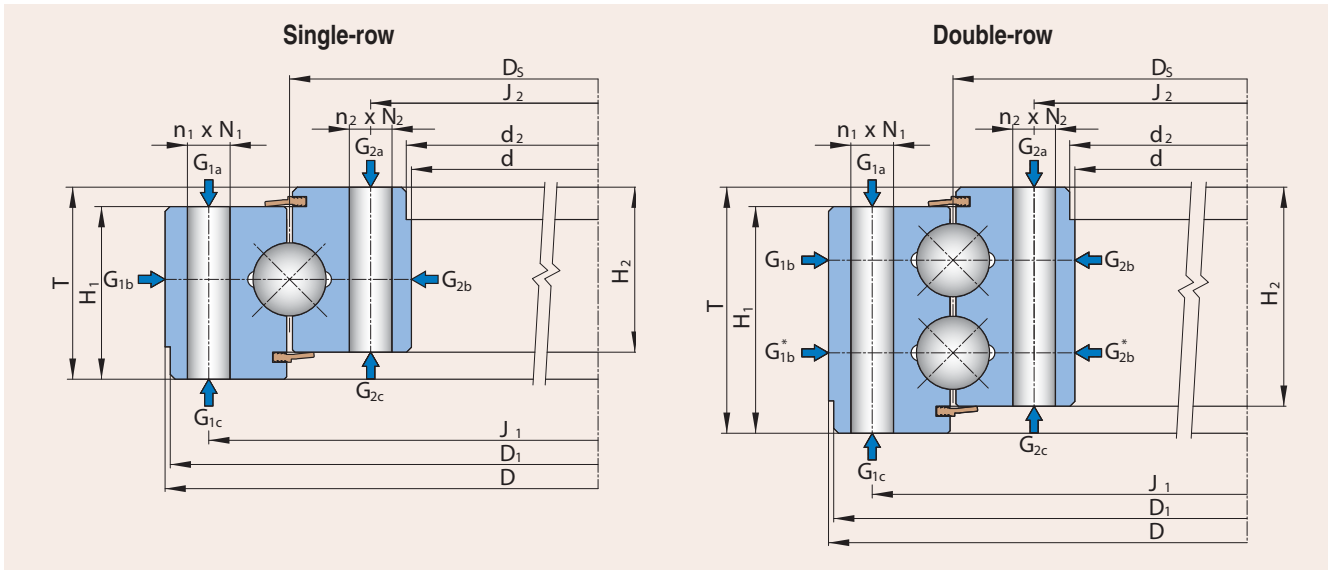

### Single-row

Boundary Dimensions			Designation	Weight G	Abutment Dimensions				Mounting Holes N <sub>1</sub>		Mounting Holes N <sub>2</sub>	
d	D	T			J <sub>1</sub>	J <sub>2</sub>	N <sub>1</sub>	N <sub>2</sub>	Number n <sub>1</sub>	Hole Type	Number n <sub>2</sub>	Hole Type
[mm]				[kg]	[mm]							
1301	1604	101	90-1B45-1455-0857	430	1560	1345	22	22	48	A	48	A
1355	1555	63	90-1B25-1455-1334	163	1515	1395	22	22	48	A	48	A
1884	2116	100	90-1B40-2000-0980	411.5	2076	1924	22	22	92	A	(92-1)	A
2200	2400	73	90-1B25-2300-0107	300	2360	2240	22	22	60	A	60	A

### Double-row

75	195	70	90-2B16-0134-0605	9.5	170	96	13	15	16	B	10	A
160	346	88	90-2B20-0268-0702	35	320	215	17.5	19	24	A	(16-2)	B
212	396	95	90-2B25-0308-0703	49	365	247	17.5	19	30	B	(24-2)	B
310	510	105	90-2B25-0410-0974	74	472	348	22	22	24	A	24	A

### Mounting holes types

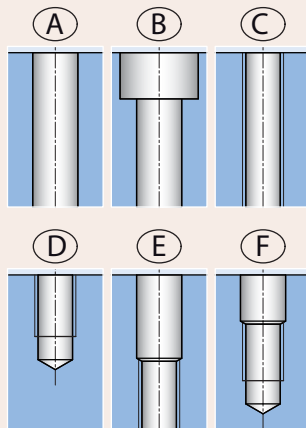

### Lubrication spots types

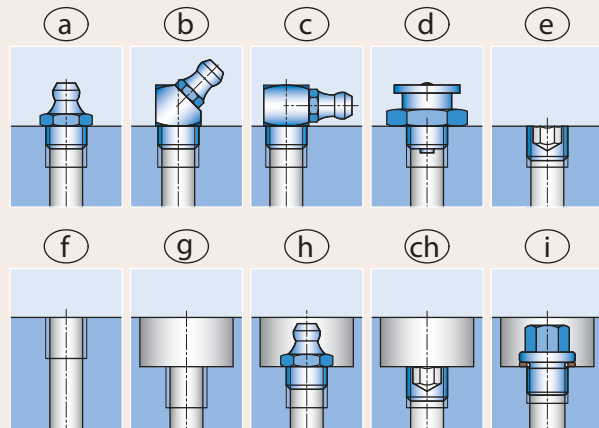

Other Specifications				Lubrication Spots				Note No.	Notes
D <sub>1</sub>	d <sub>2</sub>	H <sub>1</sub>	H <sub>2</sub>	Type	Size	Location	Number		
[mm]									
-	-	91	91	h	AM10x1	G1b	6		1 - Pilot diameter d <sub>1</sub> is on the opposite side of the inner ring
-	-	54	54	h	AM10x1	G1b	6		2 - Counterbore of the mounting holes on one (upper) side
-	-	86	86	f	M10x1	G1b	8		3 - Lubricant filling for the total lifetime
2400	2200	63	63	f	M10x1	G1b	4		

-	-	63	63	h	AM10x1	G1a	2		
346	160	78	83	h	AM10x1	G1a	2		
396	212	85	85	h	R 1/8"	G1a	2		
510	400	90	96	h	AM10x1	G1b/G1b*	2/2		

## FOUR-POINT CONTACT BALL SLEWING RINGS – without gear – special

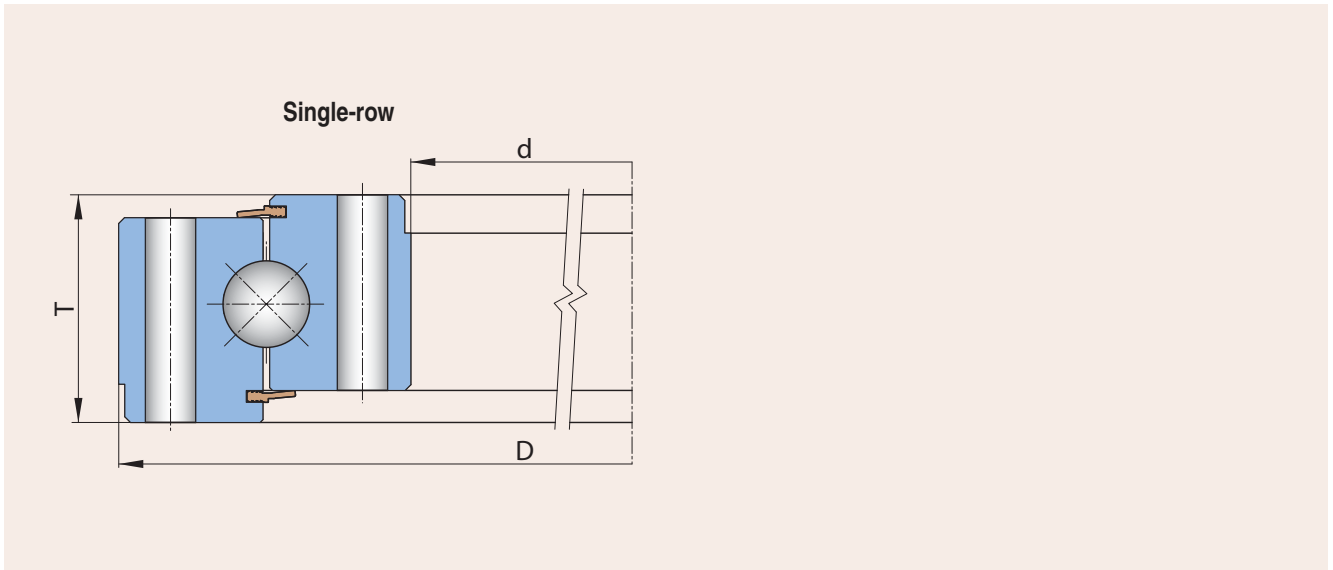

Single-row

Boundary Dimensions			Designation	Weight
d	D	T		G
[mm]				[kg]
71	185	42	90-1B16-0128-1369	6
110	280	29	90-1B10-0152-0611-1	6.5
110	214	34.5	90-1B10-0154-0914	5
120	250	44	90-1B14-0185-1366	11
125	245	25	90-1B13-0179-1068	5.5
126	259	44	90-1B14-0193-0850	8.5
138	180	15	90-1B05-0151-0566	1.1
140	340	22	90-1B17-0183-0320-1	4
140	266	22	90-1B17-0183-0332	4.5
140	266	22	90-1B17-0183-0322	4.5
140	240	22	90-1B17-0183-0320	4
140	240	22	90-1B17-0183-0245	4.1
140	266	22	90-1B17-0183-0244	5
140	300	36	90-1B13-0222-0649	13.5
145	300	45	90-1B18-0214-1364	15
145	312.1	50	90-1B22-0223-1037	19
189	332	45	90-1B20-0260-1194	17
190	360	55	90-1B20-0275-0543-1	21
190.5	241.3	25.4	90-1B13-0216-0587	2.79
191	329	46	90-1B20-0260-0825	14.5
196	270	16	90-1B06-0228-1220	2.7
200	289.64	24	90-1B14-0225-0536	4.8
200	289.5	23.75	90-1B14-0225-0360	4.8
200	290	24	90-1B14-0225-0491	5.6
200	304	30	90-1B13-0252-1160	7.3
200	309	24	90-1B13-0228-0146	5.5
200	399	66	90-1B25-0310-1215	38.5
210	365	44.5	90-1B16-0287-0802	20
210	365	40	90-1B20-0289-0295-2	18
212.8	450.7	50	90-1B22-0343-0620	39
215.9	311	25.4	90-1B13-0260-1324	7.5
219.2	590.6	106.6	90-1B25-0413-1079	122
220	310	24	90-1B14-0247-0766	6
220	310	24	90-1B14-0247-1405	6
232	400	46	90-1B20-0318-0945-1	24.5

Single-row

Boundary Dimensions			Designation	Weight
d	D	T		G
[mm]				[kg]
234.2	389	60	90-1B25-0309-0961	26.5
235	403.5	55	90-1B22-0311-1049-1	26
235	403.5	55	90-1B22-0311-1338	26
235	464	56	90-1B21-0310-0269	44
235	464	56	90-1B21-0310-0269 HL	44
240	330	60	90-1B16-0290-1101	14.5
245.1	460	92	90-1B25-0353-0750	61
250	430	45	90-1B16-0350-0804	27.5
250	430	45	90-1B16-0350-0669	27
250	430	45	90-1B16-0350-0669-1	27
265	455	75	90-1B30-0360-0340	44
270	439	45	90-1B16-0340-0601	26.5
270	439	45	90-1B16-0340-0601-1	26.5
270	486	63	90-1B25-0378-0401-1	50
276	540	67	90-1B25-0408-0292	51
276	540	67	90-1B30-0408-0866	54.5
276	541	67.8	90-1B30-0408-0604	60
290	460.2	65	90-1B20-0360-1013	38
290	460	65	90-1B20-0360-0646	44
294	546	68	90-1B25-0408-0554	52.5
294	546	68	90-1B25-0408-0986	58
304	517.9	55.9	90-1B22-0414-0490	24.5
304	518	56	90-1B20-0414-1141	28
304.8	641.4	104.8	90-1B40-0473-0586	146
304.8	641.4	104.8	90-1B40-0473-0586-1	146
305	517	56	90-1B20-0416-1142	28
323.6	520.29	54.1	90-1B25-0422-0513	46
323.9	520.3	53.8	90-1B25-0422-0854	48
324	506	66	90-1B25-0415-0695	48
325	505	48	90-1B25-0415-0853	40
325	505	66	90-1B25-0415-1021	43
325	505	66	90-1B25-0416-0981	46
333	508	72	90-1B30-0446-0502	66
335	475	45	90-1B20-0405-0229	27
342	486	56	90-1B20-0414-0684	27.5



Single-row

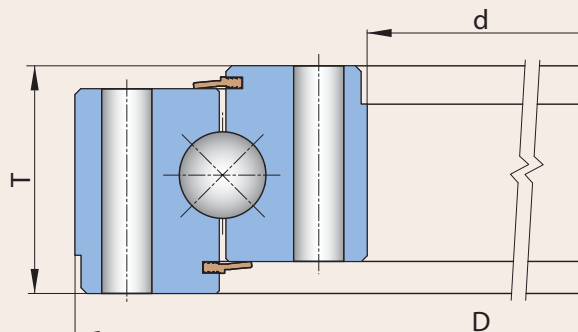

Single-row

Boundary Dimensions			Designation	Weight
d	D	T		G
[mm]				[kg]
342	486	56	90-1B20-0414-0684-1	27.5
342	486	56	90-1B20-0414-0596	29
348	570	58	90-1B20-0460-1357	65
355	455	25	90-1B14-0405-0578	11
355.6	520.34	50.8	90-1B25-0442-1170	40.5
356	570	95	90-1B33-0460-1264	73
360	500	44	90-1B20-0430-0931	25
360	587	76	90-1B32-0475-0563	64
366	577	53.5	90-1B25-0440-0714	40.5
366	579	54	90-1B25-0440-0270	42.5
366	579	54	90-1B25-0440-0270 HL	42.5
370	600	75	90-1B32-0486-1315	78
378	589.5	75	90-1B32-0474-1181	61
378	589.5	75	90-1B32-0474-1158	63.5
378	607	72	90-1B25-0474-0555	54
380	605	72	90-1B25-0474-0293	54
383	584.96	74.9	90-1B25-0475-0849	65
386	455	40	90-1B13-0418-0885	15
400	545	59	90-1B25-0475-0289	40
400	610	76	90-1B30-0506-1020	73
400	610	76	90-1B30-0506-0420	76
412.8	643.5	95.3	90-1B32-0521-1189	112.53
420	650	65.5	90-1B16-0486-0656	52
434	648	56	90-1B20-0544-1143	37
434.1	648	55.88	90-1B22-0544-0429	32
435	647	56	90-1B20-0546-1144	37
440	691	69	90-1B25-0550-0272	87
440	691	69	90-1B25-0550-0272-2	87
440	691	69	90-1B25-0550-0272 HL	87
445	616	56	90-1B20-0544-0818	43
457	692	86	90-1B22-0572-0272	105
460	600	45	90-1B20-0530-0228	36
464	708	90	90-1B40-0586-1403	121
468	704	86	90-1B40-0586-0337	108
470	632	46	90-1B25-0550-1223 S	37.5

Single-row

Boundary Dimensions			Designation	Weight
d	D	T		G
[mm]				[kg]
470	632	67	90-1B25-0550-1224 S	59
472	616	56	90-1B20-0544-0553	36
497.8	669.8	64.3	90-1B22-0584-1060	59
505	670	71	90-1B20-0590-0271	54
505	670	71	90-1B20-0590-0271 HL	54
505	670	71	90-1B20-0590-0501	61
505	670	71	90-1B20-0590-0501 HL	61
505	760	48	90-1B20-0640-0906	73.5
506.426	736.6	82.55	90-1B57-0603-1138	129
506.933	736.6	82.55	90-1B57-0603-0755	129
520	680	49	90-1B20-0595-0932	46
520	680	49	90-1B20-0595-0932-1	46
559	760	38	90-1B22-0660-0132	55.5
572	716	56	90-1B20-0644-0824	44
572	716	56	90-1B20-0644-0824-1	44
628.65	819.15	50.8	90-1B25-0724-1182	79
628.7	927.1	96.8	90-1B45-0778-0653	205
634	848.11	55.9	90-1B22-0744-0489	43.5
634	848.11	55.9	90-1B22-0744-0489-1	43.5
634	848.11	55.9	90-1B22-0744-0489-2	43.5
634	848.1	55.9	90-1B22-0744-0699	67
634.2	835.66	60.66	90-1B20-0744-0805	75
648	776	48	90-1B25-0640-0969	79
665	1065	110	90-1B57-0892-0928	357
665	1065	110	90-1B50-0900-0773	343
667	848	89	90-1B25-0762-1088	115
673.1	850.9	63.5	90-1B25-0762-1199	80.5
734.1	947.9	55.9	90-1B20-0844-0879	70
742	832	40	90-1B13-0787-0230	30.5
742	832	40	90-1B13-0787-0230-1	30.5
748.3	984	98.6	90-1B32-0868-0937	170
770	970	68	90-1B30-0871-0874	130
776	1059	60	90-1B30-0885-0979	166
810	900	40	90-1B13-0854-0160	27
834	1048	56	90-1B20-0944-0666JU	53

## FOUR-POINT CONTACT BALL SLEWING RINGS – without gear – special

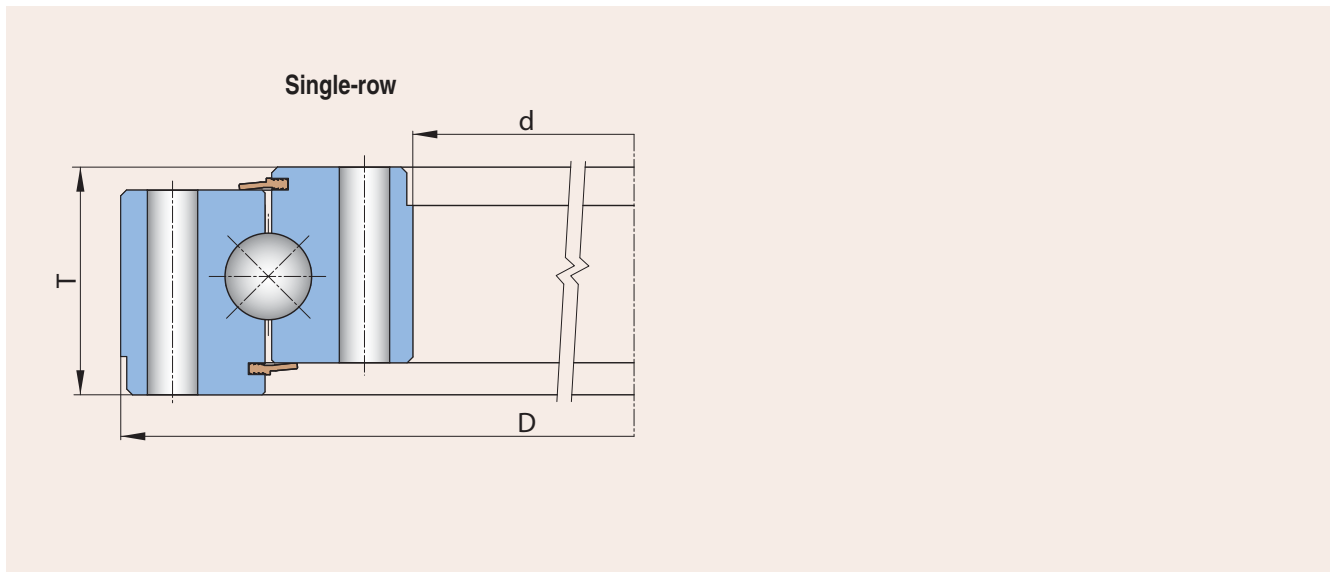

### Single-row

Boundary Dimensions			Designation	Weight
d	D	T		G
[mm]				[kg]
834	1048	56	90-1B20-0944-0666JUA	53
834	1048	56	90-1B20-0944-0919	53
850.9	1089.2	79.2	90-1B32-0970-0911	152
855	1055	63	90-1B25-0955-0535	103
855	1055	63	90-1B25-0955-0535-1	119
872	1016	56	90-1B20-0941-0357 S	70
876	1102	50	90-1B30-0984-0943	121
878.6	1121	74	90-1B30-1000-0380	162
878.6	1122	72	90-1B30-1000-0887	165
880	1023.5	42.5	90-1B17-0945-0426	49.5
890	1020	56	90-1B20-0944-0772	30
935	1195	93	90-1B35-1065-0474	270
952.5	1193.8	78.7	90-1B32-1095-1171	226
964	1198	56	90-1B22-1094-1016	101.5
984	1198	56	90-1B20-1094-0823	63
984	1198	56	90-1B22-1094-0767	118
984	1198	56	90-1B22-1094-0207	118
985	1200	56	90-1B20-1093-0941	70
985	1200	56	90-1B20-1093-0941-1	70
1127	1447	65	90-1B36-1282-0422	280
1155	1485	166	90-1B70-1315-1083	759
1184	1524	125	90-1B50-1354-1256	544
1217.1	1562.6	134.9	90-1B45-1422-0890	577
1484	1746	86	90-1B25-1627-1225	331
1562	2040	120	90-1B45-1848-0905	954
1628	1927	130	90-1B50-1778-1012	701
1810	1985	80	90-1B25-1898-0127	262.5
2093.9	2343.2	85.7	90-1B32-2219-1183	442
3017	3271.8	85.7	90-1B32-3145-1172	671

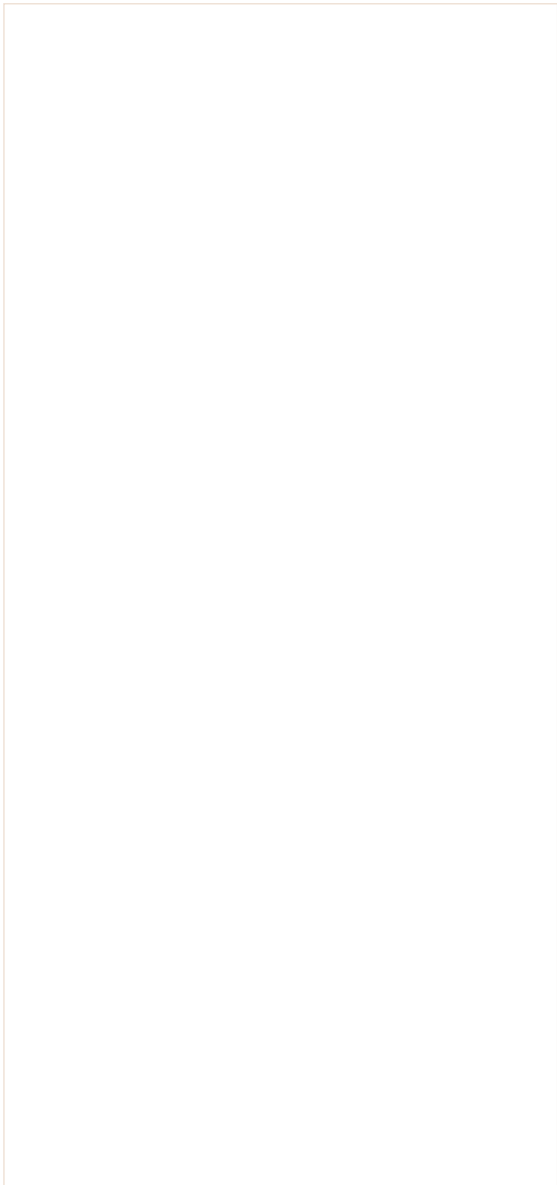

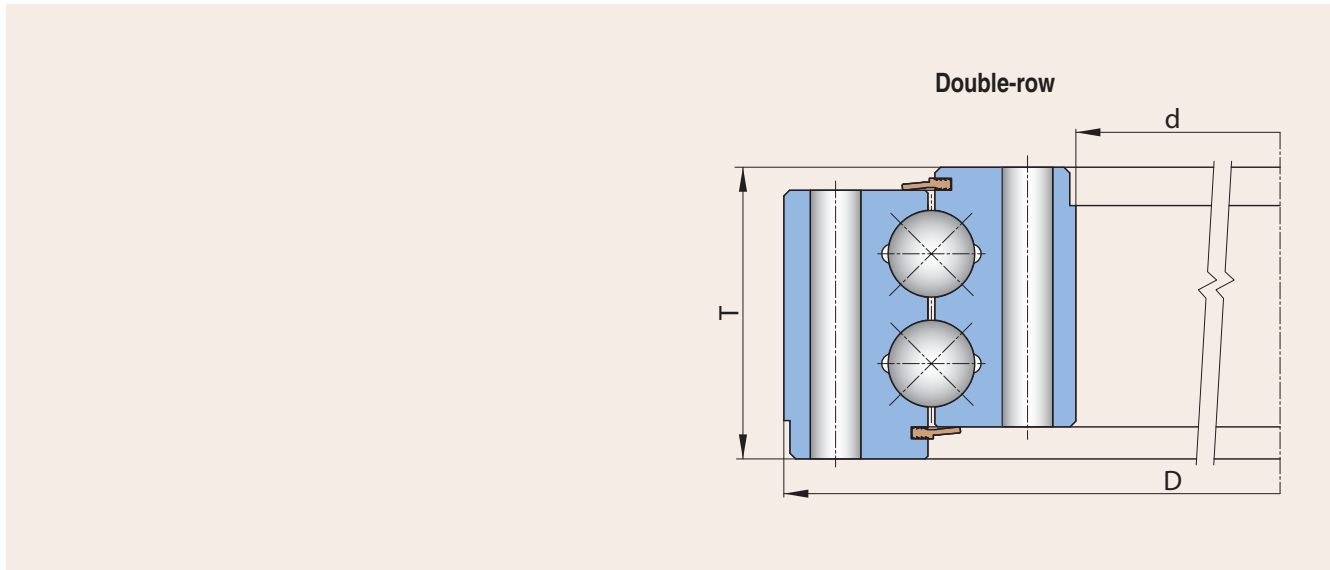

**Double-row**

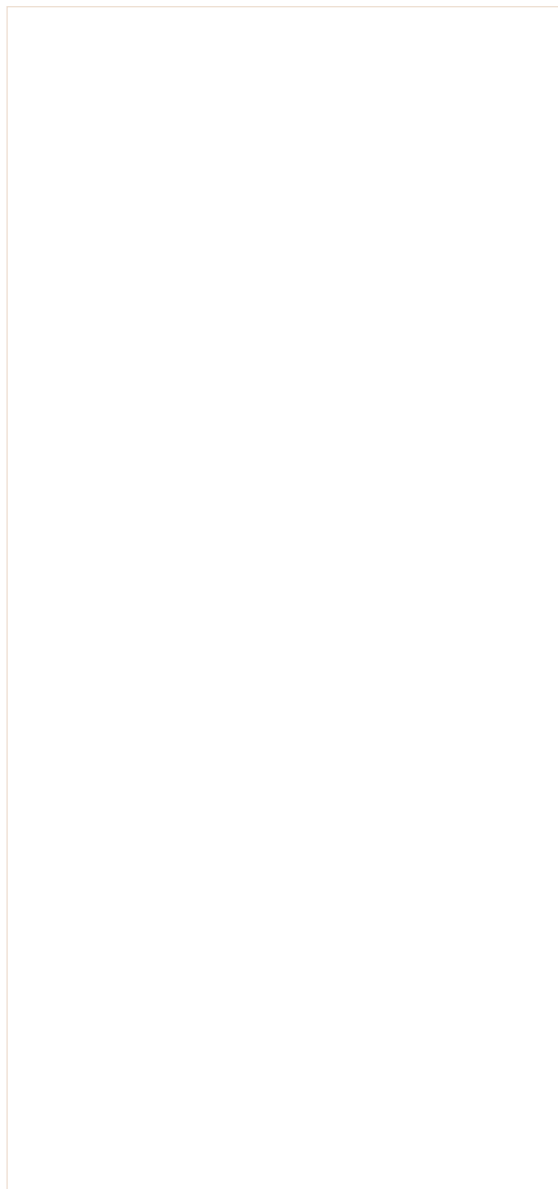

Boundary Dimensions			Designation	Weight
d	D	T		G
[mm]				[kg]
100	200	80	90-2B20-0150-0621	12
356	570	134	90-2B30-0460-1328	110
708	1000	86	90-2B20-0884-0942	99
793	948	250	90-2B20-0841-1086	170
895	1079	82	90-2B20-0971-1100	137
2200	2790	290	90-2B60-2500-1329	3845
2690	3160	165	90-2B40-2850-1282	2102
3200	3680	230	90-2B60-3490-1343	3753

## FOUR-POINT CONTACT BALL SLEWING RINGS – with external gear

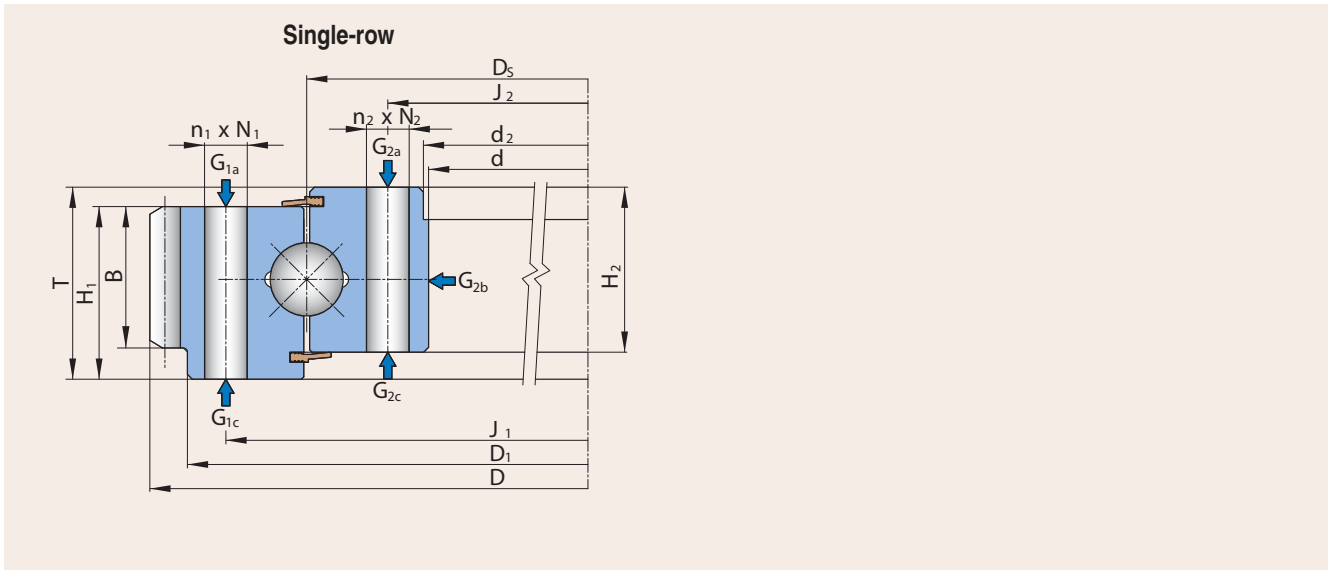

### Single-row

Boundary Dimensions			Designation	Weight G	Abutment Dimensions				Mounting Holes $N_1$		Mounting Holes $N_2$	
d	D	T			$J_1$	$J_2$	$N_1$	$N_2$	Number $n_1$	Hole Type	Number $n_2$	Hole Type
[mm]				[kg]	[mm]							
124.5	244	35	9E-1B14-0179-0624-1	7.5	214	144.5	11	11	24	A	(20-1)	A
135	259.36	35	9E-1B14-0188-1029	7.5	222	154	M10	M10	16	C	16	D
135	258	35	9E-1B16-0188-0815	7.5	222	154	M10	M10	16	C	16	D
145	312.06	50	9E-1B20-0222-0718	17	270	175	5/8-11 UNC	5/8-11 UNC	8	C	(16-2)	C
145	312	50	9E-1B20-0223-0287	16.5	270	175	5/8-11 UNC	5/8-11 UNC	16	C	(16-1)	C
145	316	50	9E-1B20-0223-1140	16.5	270	175	M14	M14	16	C	(16-1)	C
171	318.6	40	9E-1B17-0235-0182	13	275	195	13	13	12	A	12	A
179	342	42	9E-1B16-0258-0996	16	300	210	13	M12	24	A	(24-1)	C
207.9	373.1	50	9E-1B20-0288-1072	22.5	335	240	5/8-11 UNC	5/8-11 UNC	16	C	18	C
210	373	40.1	9E-1B20-0287-0983	19.5	335	240	14.3	14.3	16	A	(20-1)	A
210	373	50	9E-1B20-0289-0674-2	20	335	240	5/8-11 UNC	5/8-11 UNC	32	C	20	C
210	373	50	9E-1B20-0289-0674	21	335	240	5/8-11 UNC	5/8-11 UNC	16	C	20	C
230	350	45	9E-1B15-0282-1231	14.5	315.7	248.3	M10	M10	18	E	18	E
234	403.5	55	9E-1B20-0307-0733	23.5	358	259	13	13	24	A	20	A
235	403.5	55	9E-1B22-0308-1397	23	358	259	13	13	30	A	(28-1)	A
235	403.5	55	9E-1B22-0308-0443	23.5	358	259	13	13	30	A	(28-1)	A
235	403.5	55	9E-1B20-0309-0549	24	358	259	13	13	24	A	(28-1)	A
263.5	434	50	9E-1B22-0343-1167	27	390	295	5/8-11 UNC	5/8-11 UNC	18	C	(24-1)	C
263.5	434	50	9E-1B22-0344-0396	27	390	295	5/8-11 UNC	5/8-11 UNC	18	C	(24-1)	C
264.9	434	50.8	9E-1B20-0343-0667	28	390	295	14	14	18	A	24	A
264.9	434	50.8	9E-1B22-0343-0768	27	390	295	14	14	18	A	24	A
265	432.3	50	9E-1B20-0345-1153	24.5	390	295	17	17	18	A	24	A
265	433.5	50	9E-1B20-0345-0286	25.5	390	295	17	5/8-11 UNC	18	A	24	C
265	433.5	50	9E-1B20-0345-0273	25.5	390	295	5/8-11 UNC	5/8-11 UNC	18	C	24	C
265	433.5	57	9E-1B20-0343-0762	28	390	295	5/8-11 UNC	5/8-11 UNC	18	C	24	C
265	434	50	9E-1B20-0345-0311	28.5	390	295	1/2-13 UNC	14	8	C	8	A
304	505.5	56	9E-1B20-0411-1161	37.5	457.2	333.5	M12	17.5	24	D	(24-1)	B
305	535	75	9E-1B25-0401-0519	58	466	336	20	20	18	A	18	A
323.7	520.3	54	9E-1B25-0422-0966	46	479.4	365.1	16.3	16.3	20	A	20	D
323.7	520.3	54	9E-1B25-0422-0285	46	479.4	365.1	5/8-11 UNC	5/8-11 UNC	20	D	20	D
323.7	537.2	57.2	9E-1B25-0422-0627	47	479.4	365.1	3/4-10 UNC	20.7	18	E	16	A
323.8	520.3	54	9E-1B25-0422-0761	44	479.4	358.8	5/8-11 UNC	3/4-10 UNC	24	C	(20-1)	C
323.9	520.3	57.2	9E-1B25-0422-0989	45	479.4	365.1	5/8-11 UNC	5/8-11 UNC	20	D	20	D
324	520.3	54	9E-1B25-0422-0779	46	479.4	365.1	16.3	5/8-11 UNC	20	A	20	D
324.4	520.3	60.5	9E-1B25-0422-0816	44.5	479.4	365.1	5/8-11 UNC	3/4-16 UNF	20	C	20	C

### Mounting holes types

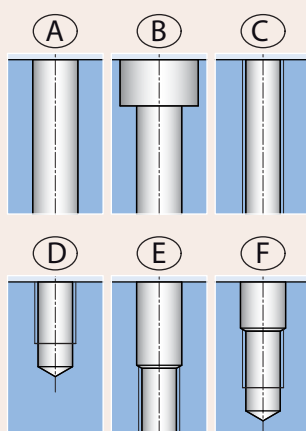

### Lubrication spots types

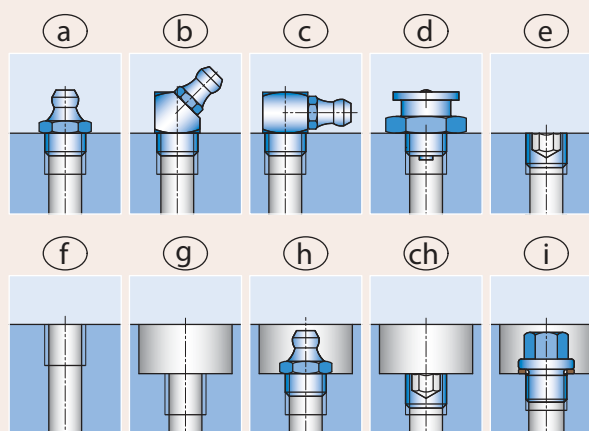

Other Specifications								Permissible Circumferential Force		Lubrication Spots				Note No.	Notes
D <sub>1</sub>	d <sub>2</sub>	H <sub>1</sub>	H <sub>2</sub>	B	m (DP)	z	x	F <sub>TDoV</sub>	F <sub>Tmax</sub>	Type	Size	Location	Number		
[mm]								[kN]							
-	-	30	30	28	2	120	0	4	8	a	AM8x1	G2b	2	1	1 – Lubricating hole without a thread
238	135	30	30	26	4	62	+0.5	10	20	f	10	G1c	2	1	2 – Thread in mounting holes has a depth of 30
238	135	30	30	26	3	84	0	6	12	a	AM8x1	G2b	1		3 – The outer ring piloted on the inner diameter
-	-	44	44	44	DP5/7	60	0	19	38	c	1/8-27 NPT	G2b	1		4 – Thread in mounting holes has a depth of 32
-	-	44	44	44	DP5/7	60	0	13	26	f	1/8-27 NPT	G2b	1	2	5 – Thread in mounting holes has a depth of 25.4
-	-	44	44	44	4	77	0	13	26	f	10	G1c	2	1	
234	173	35	35	35	4	78	0	10	20	f	M8x1	G2a	2	3	
258.5	180	35	37	30	3	112	0	7	14	f	M8x1	G2a	2	3	
-	-	43.9	43.9	43.9	DP5/7	72	0	20	40	e	1/8-27 NPT	G2b/G2c	1/1		
-	-	38.1	38.1	38.1	DP5/7	72	0	18	36	f	1/8-27 NPT	G2b	2		
-	-	44	44	38	DP5/7	72	0	18	36	f	1/8-27 NPSF	G2b	1	4	
-	-	44	44	38	DP5/7	72	0	18	36	f	1/8-27 NPSF	G2b	1	4	
-	-	40	40	40	3.5	98	0	13	26	f	7/16-20 UNF	G2a	1		
380	234.9	45	43	40	DP5/7	78	0	19	38	f	1/8-27 NPT	G1c	1		
-	-	43	46	37	4.5	88	0	13	26	h	AM6x1	G1a	2		
310	235	46	46	42	5	79	0	16	32	h	AM10x1	G1a	2	3	
380	235	43	46	37	4.5	88	0	13	26	g	M10x1	G1a	2		
344.5	263.5	43.9	43.9	43.9	DP5/7	84	0	21	42	a	1/8-27 NPT	G2b	1	3, 4	
-	-	44	44	44	DP5/7	84	0	21	42	f	1/8-27 NPT	G2b	1	2	
-	-	44.5	44.5	44.5	DP5/7	84	0	21	42	c	1/8-27 NPT	G1a	4		
-	-	44.5	44.5	44.5	DP5/7	84	0	21	42	c	1/8-27 NPT	G1a	4		
347	265	43	43	38	3	143	-0.45	9	18	f	M8x1	G2b	2	3	
-	-	43	43	43	DP5	84	0	20	40	f	1/8-27 NPT	G2b	2	2	
-	-	43	43	43	DP5/7	84	0	20	40	f	1/8-27 NPT	G2b	2		
-	-	51	43	44	DP5/7	84	0	21	42	f	1/8-27 NPT	G2b	1		
-	-	44	44	44	DP5/7	84	0	21	42	f	1/8-27 NPT	G2b	1	5	
412	-	46	46	46	DP4	78	0	24	48	a	AM8x1	G2b	2	3	
495	306	63	63	55	8	65	0	33	66	a	AM10x1	G2b	3		
-	-	52.3	52.3	52.3	DP5/7	101	0	31	62	f	1/4-28 UNF	G2b	1		
-	323.7	52.3	52.3	52.3	DP5/7	101	0	26	52	f	1/8-27 NPT	G2b	2		
-	-	50.8	50.8	50.8	DP4	83	0	30	60	a	1/8-27 NPT	G2b	1		
-	-	50.3	52.3	50.3	DP5/7	101	0	25	50	f	1/8-27 NPT	G2b	1		
-	-	50.8	50.8	50.8	DP5/7	101	0	25	50	a	1/8-27 NPT	G2b	1		
-	-	52.3	52.3	52.3	DP5/7	101	0	26	52	f	1/4-28 UNF	G2b	1		
-	-	52.3	52.3	52.3	DP5/7	101	0	26	52	a	1/4-18 NPT	G2b	1		

## FOUR-POINT CONTACT BALL SLEWING RINGS – with external gear

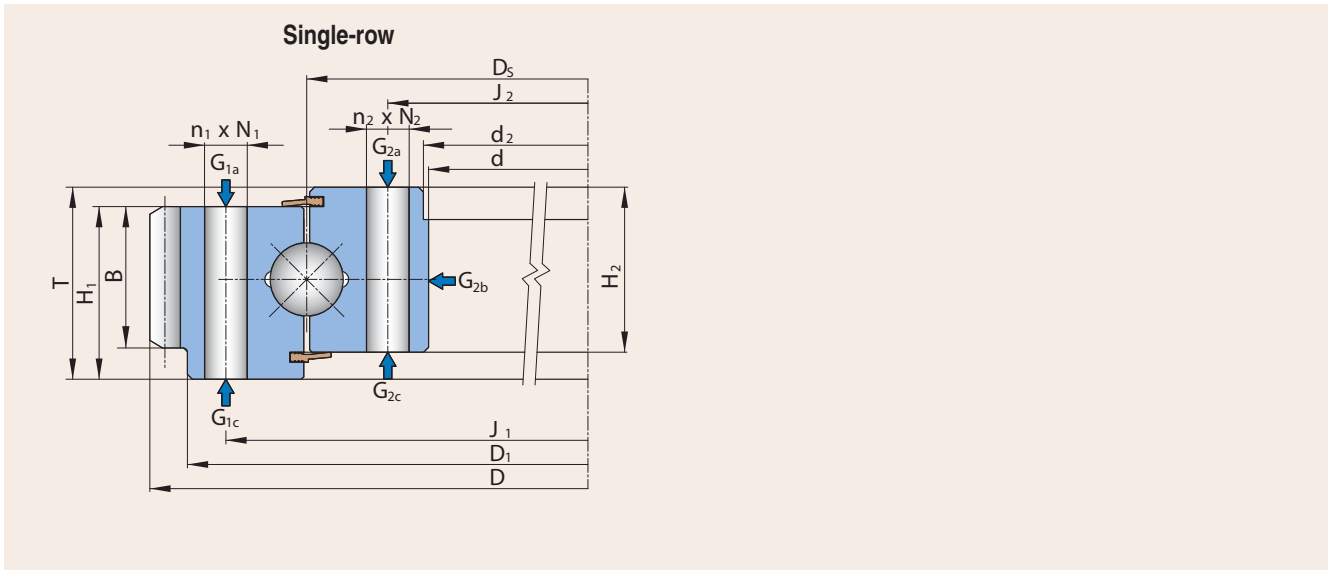

### Single-row

Boundary Dimensions			Designation	Weight G	Abutment Dimensions				Mounting Holes $N_1$		Mounting Holes $N_2$	
d	D	T			$J_1$	$J_2$	$N_1$	$N_2$	Number $n_1$	Hole Type	Number $n_2$	Hole Type
[mm]			[kg]	[mm]								
326.5	600.7	87.6	9E-1B45-0452-0742	106	539.7	365.1	20.6	20.6	18	A	(24-1)	A
327.2	600.7	96.8	9E-1B45-0452-0509	108.5	539.7	365.1	3/4-10 UNC	20.6	18	D	(24-1)	A
327.2	600.7	96.8	9E-1B45-0452-0509-1	117	539.7	365.1	3/4-10 UNC	3/4-10 UNC	24	D	(24-1)	D
327.2	600.7	87.4	9E-1B45-0453-1132	114.5	539.7	365.1	3/4-16 UNF	3/4-16 UNF	18	D	(24-1)	D
330.2	584.2	88.9	9E-1B35-0445-1057	88.5	517.5	371.5	20	20	18	B	(24-1)	B
362	581.66	73	9E-1B22-0462-0709	69	523.9	403.2	20	20	20	A	(30-1)	A
380	530	48	9E-1B16-0451-1212	30	496	406	M12	M12	18	C	18	C
382	589.5	75	9E-1B25-0475-1345	61	540	410	16	16	18	A	18	A
384	606.9	63.5	9E-1B25-0486-1063	64	546.1	422.3	3/4-10 UNC	20.5	20	E	(24-1)	A
390	654	85	9E-1B35-0508-1227	98	582	432	20	20	30	A	(30-1)	A
392	654	85	9E-1B30-0507-0548	88	582	432	20	20	30	A	(30-1)	A
412.8	654.1	88.9	9E-1B32-0521-0926	103.5	590.6	447.7	3/4-10 UNC	20.5	20	E	24	A
417	688.8	72	9E-1B25-0537-1196	90.5	605	469	M24	26	30	E	(30-1)	A
420	610	63	9E-1B25-0505-1368	54	560	450	16.5	16.5	16	A	16	A
422.1	724.7	98	9E-1B45-0557-1184	160	644.7	468.3	1-8 UNC	1-8 UNC	32	D	(32-1)	D
431	721.4	119	9E-1B45-0559-0897	170	644.7	473	20	20	24	A	28	A
431.8	657.9	87.4	9E-1B30-0533-0947	92	600.1	466.7	3/4-10 UNC	21	24	D	24	A
431.8	721.4	87	9E-1B40-0559-0457	138	644.7	473	20	20	24	B	28	B
451	671	97.5	9E-1B32-0548-1110	94.5	606.4	489	16.5	16.5	48	A	36	A
465.1	667.7	57.1	9E-1B25-0559-0964-1	63.5	622.3	495.3	3/4-10 UNC	3/4-10 UNC	18	E	18	E
465.1	667.7	57.1	9E-1B25-0559-0964-2	63.5	622.3	495.3	3/4-10 UNC	3/4-10 UNC	36	E	(36-1)	E
468.9	683.3	70	9E-1B25-0569-1193	80	627.4	511.2	3/4-16 UNF	3/4-16 UNF	36	E	(36-1)	E
474	640.3	56	9E-1B20-0545-1247	41.5	585	498	M12	M12	28	E	32	E
477.8	708.7	82.6	9E-1B25-0584-1365	100	647.7	520.7	3/4-10 UNC	3/4-10 UNC	24	E	24	E
479	695	77	9E-1B32-0574-0576-1	77	640	508	18	18	36	A	(36-1)	A
479	695	77	9E-1B25-0574-0924	81.5	640	508	M20	M20	18	C	18	C
482.6	759.1	92	9E-1B40-0613-0632	144	695.3	523.9	3/4-10 UNC	23.8	36	D	(30-1)	A
485.7	759	92	9E-1B45-0609-0651	148	695.3	523.9	3/4-10 UNC	3/4-10 UNC	30	D	(30-1)	D
529	732	63	9E-1B20-0613-0717	70	669	559	M16	17.5	24	D	24	A
534.1	740.4	56	9E-1B20-0641-0571	63	692.2	562.1	1/2-13 UNC	17.5	15	D	18	B
545	765.4	68	9E-1B25-0640-0150	84	700	580	M16	17.5	24	F	24	A
552.5	816	124	9E-1B32-0678-0430	167	753	604	20.5	20.5	36	A	(36-1)	A
556	742.3	53.5	9E-1B20-0644-0208	51	685	595	M12	13.5	44	C	44	B
558.8	817.1	95.3	9E-1B30-0679-0868	301	749.3	607.1	24	24	20	A	24	A
558.8	849.4	84	9E-1B40-0691-1149	156.5	768.4	606.4	3/4-10 UNC	20.5	28	D	28	A

### Mounting holes types

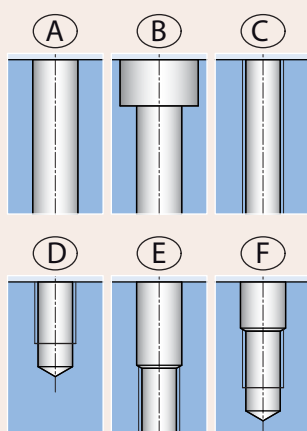

### Lubrication spots types

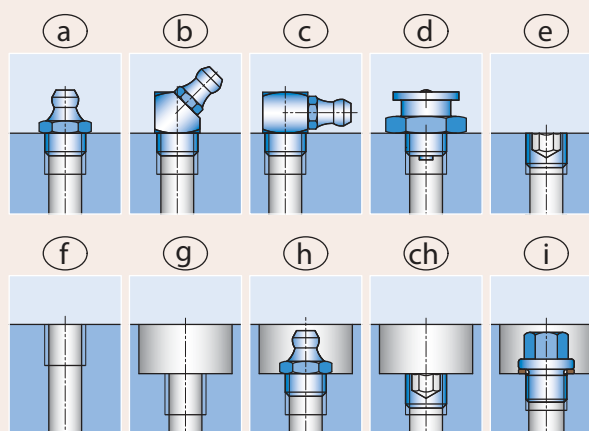

Other Specifications								Permissible Circumferential Force		Lubrication Spots				Note No.	Notes
D <sub>1</sub>	d <sub>2</sub>	H <sub>1</sub>	H <sub>2</sub>	B	m (DP)	z	x	F <sub>TDoV</sub>	F <sub>Tmax</sub>	Type	Size	Location	Number		
[mm]								[kN]							
-	-	82	82	82	DP4/5	93	0	59	118	a	1/8-27 NPT	G2b	2		1 – Lubricating hole without a thread
-	-	87.4	87.4	87.4	DP4	93	0	52	104	f	1/8-27 NPT	G2b	2		2 – Thread in mounting holes has a depth of 30
-	330.2	87.4	87.4	87.4	DP4	93	0	52	104	a	1/8-27 NPT	G2b	1		3 – The outer ring piloted on the inner diameter
-	-	82.6	82.6	82.6	DP4	93	0	50	100	a	1/8-27 NPT	G2b	1		4 – Thread in mounting holes has a depth of 32
-	332	79.5	79.5	79.5	DP4	90	0	40	80	f	1/8-27 NPT	G2a/G2c	1/1		5 – Thread in mounting holes has a depth of 25.4
466.7	363.1	70	54	70	DP4	90	0	35	70	f	1/8-27 NPSF	G2b	1	3	
-	381.5	39	39	39	3	175	0	9	18	f	M8x1	G2b	2		
565	384	60	60	40	4.5	129	0	14	28	a	AM10x1	G1a	2		
-	-	55.4	55.4	55.4	DP4	94	0	33	66	a	1/8-27 NPT	G2b	1		
-	392	73	73	60	8	80	0	44	88	f	M10x1	G2b	3		
610	392	73	66	60	8	80	0	33	66	a	AM10x1	G2b	3		
-	-	85.7	73	85.7	DP4	101	0	44	88	f	1/8-27 NPT	G2b	1		
541	417	63	59	63	6	112	+0.5	24	48	f	8	G1c	2	1	
-	-	55	55	55	5	120	0	22	44	a	AM10x1	G1a	2		
-	-	92.2	92.2	92.2	DP3	84	0	47	94	a	1/8-27 NPT	G2b	1		
-	-	98	98	98	DP4	112	0	72	144	a	1/8-27 NPT	G2b	1		
-	-	77.7	65	77.7	DP4	102	0	47	94	a	1/8-27 NPT	G2b	1		
-	-	82	82	82	DP4	112	0	50	100	f	1/8-27 NPT	G2b	1		
641	454.6	80	80	70	DP4	104	0	43	86	f	1/8-27 NPTF	G2b	2		
-	466.8	54.1	54.1	50.8	DP5/7	130	+0.0615	25	50	a	1/8-27 NPT	G2b	1		
-	466.8	54.1	54.1	50.8	DP5/7	130	+0.0615	25	50	a	1/8-27 NPT	G2b	1		
573.5	469.3	67	54	67	DP4/5	106	0	40	80	a	1/8-27 NPT	G2b	1	3	
-	-	44.5	44.5	44.5	6	105	0	19	38	f	M8x1	G2b	4		
583.7	479.5	73.2	65	73.2	DP4	110	0	22	44	a	1/8-27 NPT	G2b	2	3	
670	480	64	64	42	5	137	0	11	22	a	AM10x1	G1a/G2b	2/2		
371	480	64	64	42	5	137	0	20	40	a	AM10x1	G1a	2		
-	482.6	82.6	82.6	75.2	DP3.5	103	0	52	104	a	1/8-27 NPT	G2b	1		
-	489	82.6	82.6	82.6	DP3.5	103	0	58	116	a	1/8-27 NPT	G2b	2		
-	-	53	53	53	6	120	0	23	46	a	AM10x1	G2b	2		
-	-	46	46	46	DP4	115	0	28	56	h	1/4-28 UNF	G2b	4		
-	-	59	53	59	8	92	+1	45	90	f	M10x1	G2b	3		
-	-	92	92	82.5	6	132	0	57	114	f	1/8-27 NPT	G2b	2		
-	-	44.5	44.5	44.5	6	122	0	20	40	h/a	AM8x1	G1a/G2b	4/4		
682	560	78.1	75.3	73	DP3.5	111	0	50	100	a	1/8-27 NPT	G2b	2	3	
-	-	76.2	76.2	76.2	DP2.5	82	0	86	172	a	1/8-27 NPT	G2b	4		



## FOUR-POINT CONTACT BALL SLEWING RINGS – with external gear

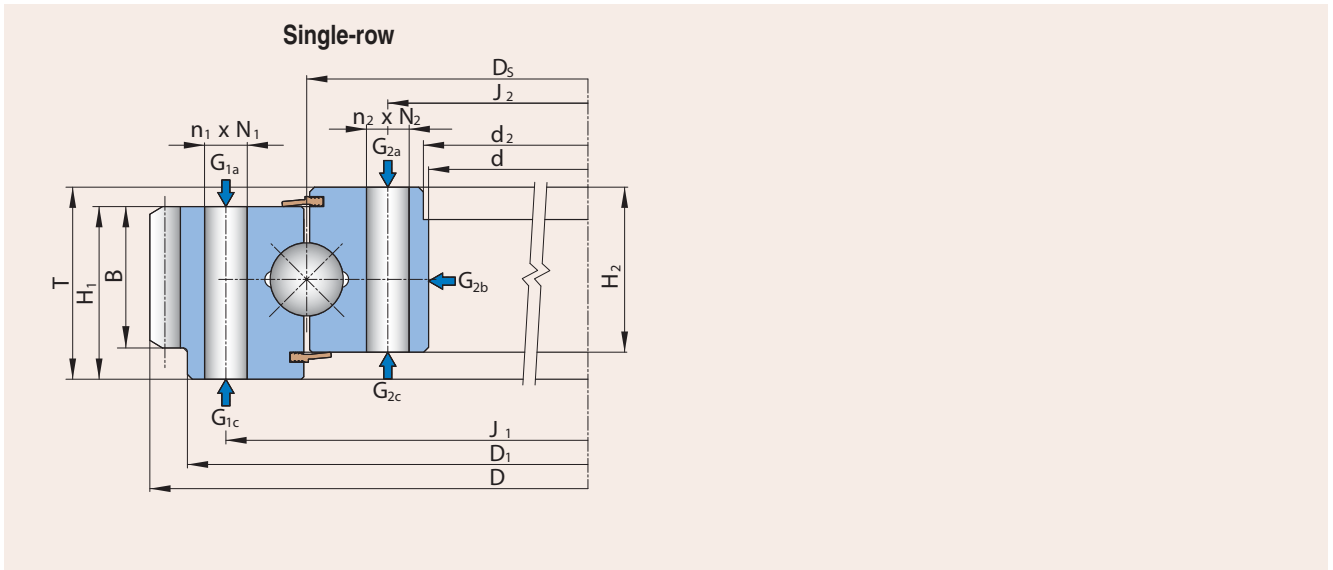

### Single-row

Boundary Dimensions			Designation	Weight G	Abutment Dimensions				Mounting Holes N <sub>1</sub>		Mounting Holes N <sub>2</sub>	
d	D	T			J <sub>1</sub>	J <sub>2</sub>	N <sub>1</sub>	N <sub>2</sub>	Number n <sub>1</sub>	Hole Type	Number n <sub>2</sub>	Hole Type
[mm]			[kg]	[mm]								
577	829.9	68	9E-1B30-0685-0677	112	753	617	22	22	24	A	24	A
619.3	867.9	104.9	9E-1B30-0725-0900	168	796.9	654	3/4-10 UNC	3/4-10 UNC	36	D	(36-1)	D
635	849.4	55.9	9E-1B20-0741-0999	75.5	787.4	673.1	1/2-13 UNC	1/2-13 UNC	30	D	30	D
654	892.8	74.7	9E-1B32-0762-0609	137	831.9	692.2	3/4-10 UNC	3/4-10 UNC	30	E	30	E
666.8	869.7	101.6	9E-1B25-0762-0998	138	800.1	704.9	3/4-10 UNC	3/4-10 UNC	30	D	30	D
667	888	69	9E-1B25-0762-0321	107	819	703	M16	17.5	32	D	32	A
676.4	892.8	79.5	9E-1B30-0772-0664	122	835	708	17	17	30	B	36	B
679	863	82	9E-1B25-0765-1347	97	800	706	M16	M16	24	D	24	E
715	952	76	9E-1B25-0812-1249	128	870	754	M16	M16	32	E	32	E
715	979	100	9E-1B35-0823-1175	173.5	893	753	22	22	36	A	36	A
715	979	94	9E-1B35-0823-0933	152.5	893	753	22	22	36	A	36	A
717.6	981.7	125	9E-1B45-0854-0545	253	908	762	1-8 UNC	28.6	24	D	(30-1)	A
717.6	981.7	125	9E-1B45-0854-0343-1	250	908	762	1-8 UNC	1-8 UNC	36	D	(36-1)	D
727.2	1023.6	104.8	9E-1B32-0848-0938	235.5	920.8	774.5	24	7/8-9 UNC	36	A	(36-1)	D
730	1006.6	98	9E-1B35-0845-0476	196	920	770	M20	M20	20	E	20	E
730.3	1062.7	82.6	9E-1B40-0876-1105	241	965.2	787.4	27	27	20	A	24	A
778	1102	80	9E-1B40-0910-0345	205	990	830	26	26	40	A	(40-1)	A
817	1072.9	80	9E-1B25-0920-1162	167.5	990.6	857.3	21	3/4-10 UNC	40	A	40	E
828.5	1093.2	88.9	9E-1B32-0940-1401	185	1012.8	866.8	21	3/4-10 UNC	36	A	(36-1)	E
828.8	1093.2	96.8	9E-1B32-0940-1186	191	1012.8	866.8	24	24	36	A	36	A
828.8	1093.2	96.8	9E-1B32-0940-0960	191	1012.8	866.8	24	24	36	A	36	A
835.2	1062.7	88.9	9E-1B32-0933-0531	174	993.8	873.1	7/8-9 UNC	7/8-9 UNC	30	D	30	D
861.8	1174.5	96.8	9E-1B40-1002-1000	264	1087.4	916	7/8-9 UNC	24	30	E	30	A
863.1	1174.5	96.8	9E-1B40-1002-1025	265	1087.4	916	21	3/4-10 UNC	36	A	36	E
873.3	1163.3	117.5	9E-1B35-0995-0954	145	1070	920.8	24	24	32	A	36	A
882.6	1083.4	100	9E-1B25-0985-0796	150	1015	922	3/4-10 UNC	21	30	D	30	A
885	1173.6	82	9E-1B32-1000-0223	198	1070	929	22	22	52	A	(52-1)	A
887.7	1089	90.4	9E-1B25-0978-0533	132	1015	922	M16	18	30	D	30	A
889	1204.7	100.1	9E-1B40-1029-0652	307	1114.4	943	1-8 UNC	1-8 UNC	30	D	30	D
894.5	1078	82	9E-1B25-0969-1205	126.5	1015	922	M16	M16	30	D	30	D
894.5	1078	90	9E-1B25-0969-1289	125	1015	922	M16	M16	30	D	30	D
895	1077.7	82	9E-1B22-0975-1173	127	1015	922	M16	17.5	24	D	24	A
955	1324	137	9E-1B45-1105-0329	480	1200	1010	M24	26	42	F	42	A
960	1216.7	80	9E-1B30-1072-0836-1	208	1145	997	17.5	17.5	30	B	30	B
976	1200	110	9E-1B35-1077-0542-1	237	1135	1012	M18	19	40	D	40	B



### Mounting holes types

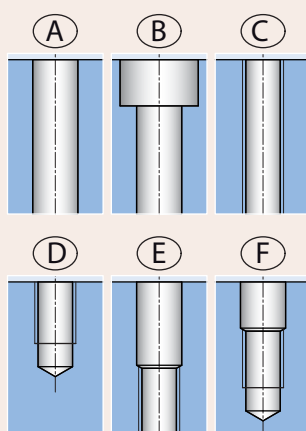

### Lubrication spots types

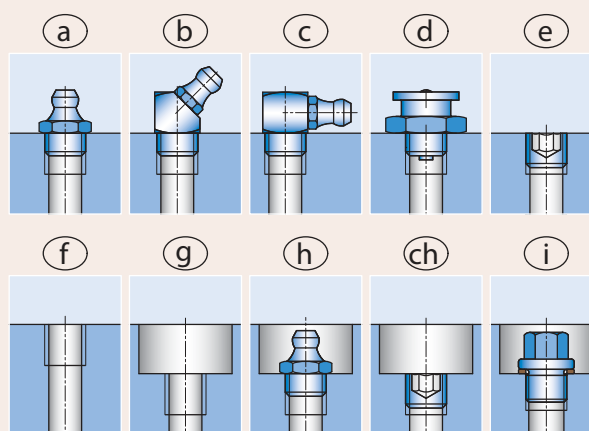

Other Specifications								Permissible Circumferential Force		Lubrication Spots				Note No.	Notes
D <sub>1</sub>	d <sub>2</sub>	H <sub>1</sub>	H <sub>2</sub>	B	m (DP)	z	x	F <sub>TDoV</sub>	F <sub>Tmax</sub>	Type	Size	Location	Number		
[mm]								[kN]							
-	579	61	61	61	8	102	0	25	50	a	AM10x1	G2b	4	1 – Lubricating hole without a thread	
-	-	85.9	88.9	85.9	DP3.5	118	0	60	120	a	1/8-27 NPT	G2b	1	2 – Thread in mounting holes has a depth of 30	
-	-	45.7	45.7	45.7	DP2.5	82	0	43	86	a	1/8-27 NPT	G2b	2	3 – The outer ring piloted on the inner diameter	
-	-	65	65	65	DP4/5	139	0	40	80	a	1/8-27 NPT	G2b	2	4 – Thread in mounting holes has a depth of 32	
-	670.1	89	82.6	89	DP2.5	84	0	101	202	a	1/8-27 NPT	G2b	2	5 – Thread in mounting holes has a depth of 25.4	
-	-	60	57	60	8	108	+0.6	56	112	f	M10x1	G2b	4		
-	679.5	71.4	71.4	71.4	DP4/5	139	0	55	110	c	1/8-27 NPT	G2b	2		
771.5	680	68	65	60	6	142	0	34.5	69	f	M10x1	G2b	2	3	
814	724	67	62	60	10	92	+0.7	55	110	f	M8x1	G2b	2	3	
933	718	83	84	67	10	94	+1.1	44	88	f	M10x1	G1a/G2b	4/4		
845	718	74	74	74	10	94	+1.1	71	142	f	M10x1	G2b	4	3	
858.3	720.9	115.06	95.25	83	DP4	153	0	60	120	f	1/8-27 NPT	G2b	4	3	
858.3	720.9	115	95.25	83	DP4/5	153	0	50	100	f	1/8-27 NPT	G2b	2	3	
-	-	95.3	85.7	95.3	DP2	79	0	111	222	a	1/8-27 NPT	G2b	2		
-	730	80	79	70	8	122	0	54	108	f	G 1/4	G2a	4		
-	-	73.15	73.15	66.8	DP2.5	103	0	54	108	a	1/8-27 NPT	G2b	2		
-	780	72	72	72	12	89	+0.5	100	200	f	M10x1	G2b	4		
-	-	70	70	70	DP2.5	104	0	82	164	f	M6	G2b	4		
-	831.8	69.9	79.2	69.9	DP2.5	106	0	82	164	a	1/8-27 NPT	G2b	2		
-	-	69.9	87.4	69.9	DP2.5	106	0	82	164	a	1/8-27 NPT	G2b	2		
-	-	69.9	87.4	69.9	DP2.5	106	0	68	136	f	1/8-27 NPT	G2b	2		
-	-	76.2	76.2	76.2	DP2.5	103	0	74	148	f	1/8-27 NPT	G2b	2		
-	-	76.2	87.4	76.2	DP2.5	114	0	74	148	f	1/8-27 NPT	G2b	2		
-	-	76.2	87.4	76.2	DP2.5	114	0	74	148	a	1/8-27 NPT	G2b	2		
-	-	92.2	92.2	76.2	DP2	90	0	91	182	a	1/8-27 NPT	G2b	4		
-	-	91.3	66.8	66	DP2.5	105	0	64	128	f	1/8-27 NPT	G2b	2		
-	885	68	68	68	12	95	+0.5	79	158	f	M10x1	G2b	6		
984.2	890	75	67	75	9	119	0	65	130	a	AM10x1	G2b	3	3	
-	-	85.9	87.4	85.9	DP2.5	117	0	100	200	a	1/8-27 NPT	G2b	2		
-	-	70	70	60	8	131	+1.07	55	110	f	M10x1	G2b	3		
987	-	70	70	60	8	131	+1.07	55	110	f	M10x1	G2b	3	3	
387	-	72	67	64	8	130	+1.475	59	118	a	AM10x1	G2b	4	3	
1105	960	122	117	100	14	91	+0.93	154	308	a	AM10x1	G2b	4	3	
1187	960	71	70	55	6	192	+0.5	33	66	f	Rp 1/4	G2a	6		
-	-	100	100	100	8	148	0	53	106	f	M10x1	G2b	4		

## FOUR-POINT CONTACT BALL SLEWING RINGS – with external gear

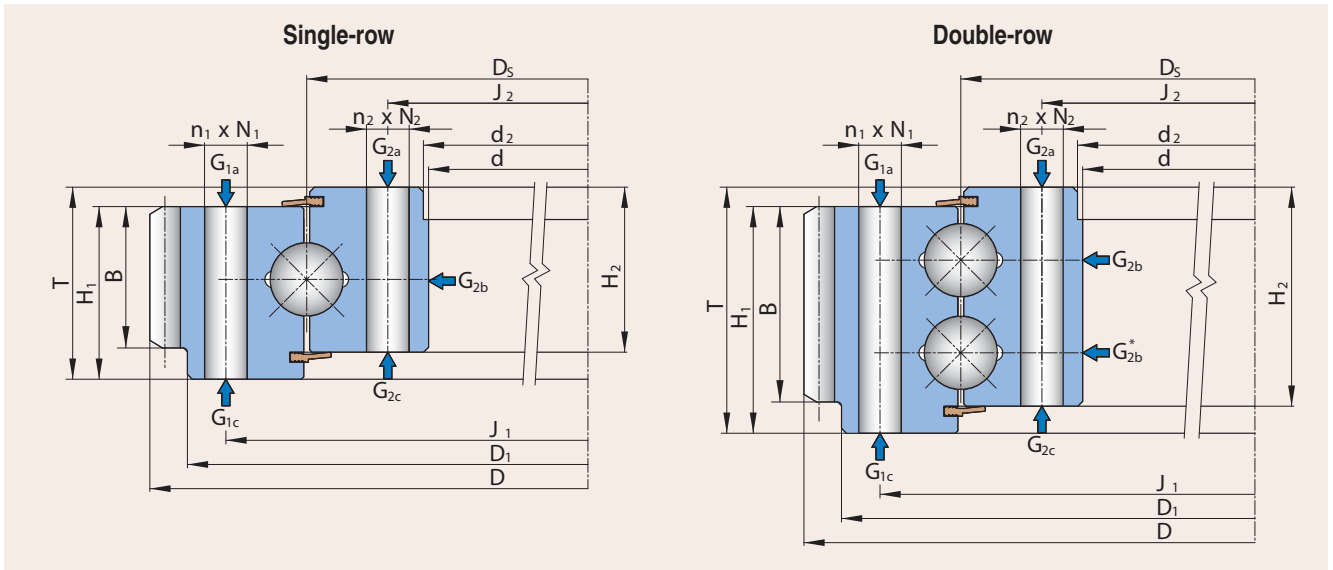

### Single-row

Boundary Dimensions			Designation	Weight G	Abutment Dimensions				Mounting Holes $N_1$		Mounting Holes $N_2$	
d	D	T			$J_1$	$J_2$	$N_1$	$N_2$	Number $n_1$	Hole Type	Number $n_2$	Hole Type
[mm]				[kg]	[mm]							
984.3	1229.4	88.9	9E-1B32-1086-0530	205	1149.4	1022.4	7/8-9 UNC	7/8-9 UNC	36	D	36	D
991.4	1396.8	120.7	9E-1B57-1165-0388	538	1276.4	1050.9	33	33	27	A	(36-1)	A
1004	1200	60	9E-1B22-1087-1015	105	1135	1035	14	18	36	A	24	A
1020	1268	90	9E-1B30-1122-0455	212	1185	1058	M16	17	40	F	40	A
1045	1358	98	9E-1B35-1180-0813	320.5	1260	1100	22	22	40	A	40	A
1079.5	1450.3	127	9E-1B50-1224-0370	435	1320.8	1127.1	27	27	28	A	(36-1)	A
1092.2	1377.7	101.6	9E-1B40-1213-0433	336	1290.1	1135.1	23.8	23.8	36	A	36	A
1092.2	1377.7	101.6	9E-1B40-1213-1108	336	1290.1	1135.1	7/8-9 UNC	24	36	E	36	A
1140	1332	85	9E-1B22-1220-1342	151	1270	1170	M18	M18	36	E	36	E
1143	1460	110	9E-1B40-1278-1244	404.5	1360	1195	26	26	40	A	40	A
1143	1464	110	9E-1B40-1278-1349	405	1360	1195	26	26	40	A	40	A
1228.9	1635.7	108	9E-1B50-1399-1332	598	1504.9	1292.2	1 1/4-7 UNC	33	30	D	36	A
1310	1756.8	130	9E-1B60-1495-1300	785	1608	1382	M33	36	48	E	(48-1)	A
1336	1673	104	9E-1B40-1476-0838	453	1560	1390	M24	26	40	E	40	A
1419.2	1900	161.9	9E-1B75-1641-0753	1261	1784.4	1485.9	1 1/4-7 UNC	1 1/4-7 UNC	45	D	(48-1)	D
1531.9	1915	119.1	9E-1B50-1700-1195	734	1805	1595	30	30	48	A	48	A
1680	2028	120	9E-1B40-1830-0521	620	1915	1745	30	30	48	A	48	A
1702	2088	150	9E-1B50-1865-0812	960	1970	1756	26	26	36	A	36	A
1725	2174	170	9E-1B60-1908-1358	1347	2020	1796	33	33	40	B	40	A
1839	2290	128	9E-1B60-2020-1240	1091	2135	1905	33	33	76	A	(76-1)	A
1940	2441	140	9E-1B60-2140-1204	1430	2290	2010	33	33	48	B	48	A
2765	3216	156	9E-1B50-2944-1211	1809	3050	2820	33	33	30	A	30	A
2914	3198	90	9E-1B32-3031-1399	688	3104	2958	22	22	48	A	48	A
3400	3866.4	185	9E-1B60-3585-1387	2621	3710	3460	33	33	78	A	78	A

### Double-row

417	688.8	102	9E-2B25-0539-1191	137	605	469	M24	26	30	E	(30-1)	A
895	1077.7	100	9E-2B20-0970-1121	159	1015	922	M16	17.5	36	D	42	A
1772	2040	125	9E-2B30-1875-0790	525	1940	1810	M20	M20	48	D	48	E
1879	2226	175	9E-2B40-2010-1197	1180	2105	1910	M30	33	60	D	60	E

### Mounting holes types

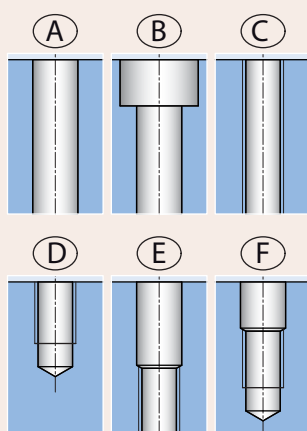

### Lubrication spots types

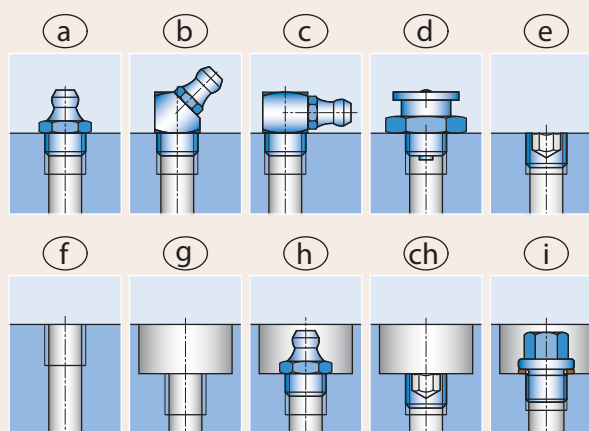

Other Specifications								Permissible Circumferential Force		Lubrication Spots				Note No.	Notes
D <sub>1</sub>	d <sub>2</sub>	H <sub>1</sub>	H <sub>2</sub>	B	m (DP)	z	x	F <sub>TDoV</sub>	F <sub>Tmax</sub>	Type	Size	Location	Number		
[mm]								[kN]							
-	-	76.2	76.2	76.2	DP2.5	119	0	62	124	a	1/8-27 NPT	G2b	2	1 – Lubricating hole without a thread	
-	-	111.25	111.25	101.6	DP1.5708	108	0	124	248	f	1/8-27 NPT	G2b	2	2 – Thread in mounting holes has a depth of 30	
1160	1005	47	53	40	8	148	0	23	46	f	M10x1	G2b	4	3 – The outer ring piloted on the inner diameter	
-	-	80	62	80	10	123	+0.9	77	154	f	M10x1	G2b	4	4 – Thread in mounting holes has a depth of 32	
1185	1050	88	80	88	10	133	+0.5	85	170	f	M10x1	G2b	4	3 5 – Thread in mounting holes has a depth of 25.4	
-	1082.6	114.3	101.6	101.6	DP1.5	84	+0.1752	160	320	f	1/8-27 NPT	G2b	2		
-	-	85.85	88.9	82.6	DP2.5	134	0	80	160	f	1/8-27 NPT	G2b	2		
-	-	85.9	88.9	82.6	DP2.5	134	0	80	160	a	1/8-27 NPT	G2b	2		
-	-	70	59	50	6	220	0			a	M10x1	G2b	3		
-	-	100	100	95	10	144	0	91	182	a	M10x1	G2b	4		
-	1143	100	100	95	12	120	0			f	M10x1	G1a	4		
-	1232.1	98.6	98.6	98.6	DP1.5	95	0			a	1/8-27 NPT	G2b	2		
-	-	120	120	119.5	16	107	+0.5			f	M10x1	G2b	8		
-	-	96	84	96	13	125	+0.8461	120	240	f	M10x1	G2b	2		
-	1421	152.4	152.4	101.6	DP2	148	0	124	248	a	1/8-27 NPT	G2b	4		
-	-	109.5	109.5	109.5	10	188	+0.8	106	212	a	1/8-27 NPT	G2b	4		
-	-	90	100	90	10	200	+0.4	72	144	f	M10x1	G2b	6		
-	1705	127	120	100	10	205	+0.9	97	194	f	M10x1	G2b	6		
1911	1730	160	150	150	18	118	+0.5			a	M10x1	G2b	8	3	
-	-	118	118	110	10	228	-0.5	88	176	f	M10x1	G2b	12		
2356	-	130	130	120	16	150	+0.3	184	368	a	AM10x1	G2b	6		
-	2765	117	150	117	20	158	+0.5	226	452	f	M10x1	G2b	6		
3034	-	77	77	77	10	318	0			f	M10x1	G2b	12	3	
-	-	138	178	138	18	212	+0.5			h	AM10x1	G2b	13		

541	417	93	89	63	6	112	+0.5	36	72	f	8	G1c	4	1	
-	-	89	94	68	8	130	1.5	53	106	f	M10x1	G2b/G2b*	2/2		
-	-	100	110	90	12	168	-	86	172	f	M10x1	G2b/G2b*	4/4		
-	-	145	168	120	14	156	+0.5	162	324	a	AM10x1	G2b/G2b*	6/6		

## FOUR-POINT CONTACT BALL SLEWING RINGS – with external gear – special

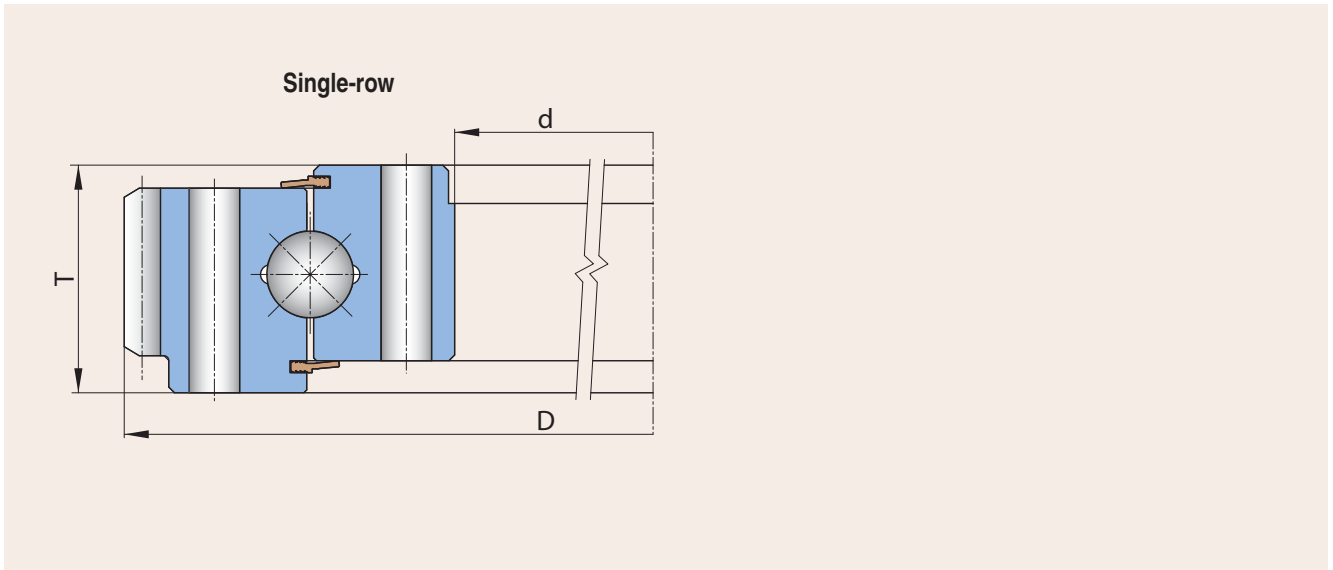

Single-row

Boundary Dimensions			Designation	Weight
d	D	T		G
[mm]				[kg]
101.6	238.8	38	9E-1B20-0163-0626	9
101.6	238.8	49	9E-1B22-0163-0607	10
101.6	238.8	49	9E-1B22-0163-0547	10
101.6	239	56	9E-1B20-0163-0744-A05	11
124.5	244	35	9E-1B14-0179-0624	8
125	244	25	9E-1B13-0181-1089	5.5
144.8	312.1	50	9E-1B20-0223-0899	18
145	314.2	50	9E-1B22-0223-0593	17.5
145	316.6	50	9E-1B20-0223-0540	18
145	316.6	50	9E-1B20-0223-0201	18
145	316.6	50	9E-1B20-0223-0282	18
145	316.6	50	9E-1B20-0221-0493	16.5
145	316.6	50	9E-1B20-0223-0720-A01	17
145	316.6	50	9E-1B20-0223-0720-A02	17
145	316.6	50	9E-1B20-0223-0720-A03	17
145	316.6	50	9E-1B20-0223-0720-A04	17
145	316.6	50	9E-1B20-0223-0720-A05	17
145	316.6	50	9E-1B20-0223-0720-A06	17
145	316.6	50	9E-1B20-0223-0720-A07	17
145	316.6	50	9E-1B20-0223-0720-A08	17
145	322.3	83	9E-1B22-0226-1371-D15	27.6
145	322.3	83	9E-1B22-0226-1372-H15	29.2
145	342.4	84	9E-1B20-0223-0794-D01	32
145	342.4	84	9E-1B20-0223-0794-D04	32
172	354	45	9E-1B14-0289-0787	19.5
172	354	45	9E-1B14-0289-0787-1	19.5
179	342	42	9E-1B16-0254-1107	16.5
179	342	42	9E-1B16-0254-1107-1	16.5
179	349	47	9E-1B16-0260-0973	19
179	349	47	9E-1B16-0260-0973-1	19
180	342	42	9E-1B16-0254-1370	17
190	348	45	9E-1B20-0260-0786	18
195	373	56	9E-1B25-0278-1048	25
195	373	56	9E-1B25-0278-1048-1	24.5
210	373	40	9E-1B20-0287-0499	18.5

Single-row

Boundary Dimensions			Designation	Weight
d	D	T		G
[mm]				[kg]
210	373	40.1	9E-1B20-0287-0442	19.5
210	373	40.1	9E-1B20-0287-0659	19.5
210	373	40.1	9E-1B20-0287-0659-1	19.5
210	373	40.1	9E-1B20-0287-0659-2	19.5
210	373	50	9E-1B20-0289-0674-1	21
210	373	50	9E-1B20-0289-0763	21
235	402.1	58	9E-1B20-0310-1346-B09	27.8
235	403.5	55	9E-1B22-0311-0917	24.5
235	403.5	55	9E-1B22-0311-0917-1	24.5
260	437.3	50	9E-1B20-0338-1006	28
265	434.8	50	9E-1B22-0343-0592	26.5
265	437.3	50	9E-1B20-0345-0202	30
265	437.3	50	9E-1B20-0345-0202-1	25.5
265	437.3	50	9E-1B20-0345-0280	29
265	437.3	50	9E-1B20-0345-0492	25.5
265	437.3	50	9E-1B20-0343-0541	28
265	437.3	50	9E-1B20-0343-0698	28
265	437.3	50	9E-1B20-0343-0719-A01	28
265	437.3	50	9E-1B20-0343-0719-A02	28
265	437.3	50	9E-1B20-0343-0719-A03	28
265	437.3	50	9E-1B20-0343-0719-A04	28
265	437.3	50	9E-1B20-0343-0719-A05	28
265	437.3	50	9E-1B20-0343-0719-A06	28
265	437.3	50	9E-1B20-0343-0719-A07	28
265	437.3	50	9E-1B20-0343-0719-A08	28
265	437.5	80	9E-1B20-0343-0741-1	37
265	437.5	80	9E-1B20-0343-0741-4	37
265	439	50	9E-1B20-0345-0281	30
265	469	84	9E-1B20-0343-0977-H01	50.3
265	469	84	9E-1B20-0343-0977-H04	50.5
265.9	434	40.1	9E-1B20-0343-1298	23
291.3	464.5	40.1	9E-1B22-0374-0731	28
291.3	464.5	40.1	9E-1B22-0374-0731-1	28
304	505.5	55.9	9E-1B22-0402-1003	40
304	505.5	56	9E-1B22-0414-0707	31

Single-row

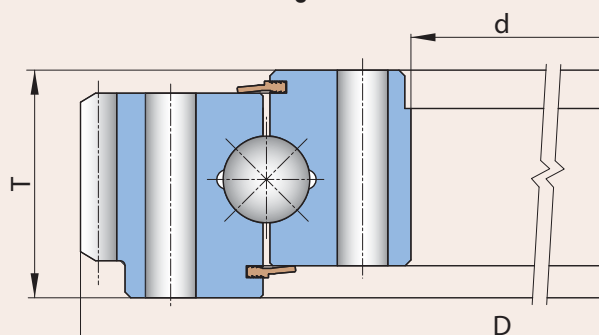

Single-row

Boundary Dimensions			Designation	Weight
d	D	T		G
[mm]				[kg]
304	505.5	56	9E-1B20-0411-0982	32
304	505.5	56	9E-1B20-0411-0982-1	32
319	530.2	71.4	9E-1B32-0419-0398	68
319	530.2	71.4	9E-1B32-0420-0508-1	70
320.5	600.7	104.9	9E-1B40-0453-0949	121
320.5	607.1	87.4	9E-1B45-0453-1360	115
322.3	520.3	54	9E-1B22-0422-0603	44
322.6	520.3	52.4	9E-1B25-0422-0867	45.5
323.7	520.3	54	9E-1B25-0422-0354	46
323.7	537.2	57.2	9E-1B25-0422-0477	47
323.9	520.1	54.1	9E-1B25-0422-0481	46
323.9	520.1	54.1	9E-1B25-0422-0481-1	46
323.9	520.2	55.6	9E-1B25-0421-0869	45
323.9	520.2	55.6	9E-1B25-0421-0869-1	45
323.9	518.7	56	9E-1B25-0422-0594	46
323.9	520.3	54	9E-1B22-0422-0618	44
323.9	520.3	54	9E-1B22-0419-0940	44
323.9	609.6	95.2	9E-1B45-0453-1213	115.5
324	527.8	60	9E-1B22-0422-0516	48
324	527.8	60	9E-1B22-0422-0732-A01	45
324	527.8	60	9E-1B22-0422-0732-A02	45
324	527.8	60	9E-1B22-0422-0732-A03	45
324	527.8	60	9E-1B22-0422-0732-A04	45
324	552	83	9E-1B22-0422-0923-D01	74.5
324	552	83	9E-1B22-0422-0923-D15	74.5
327.2	600.7	87.38	9E-1B45-0453-0505	114.5
327.2	600.7	87.38	9E-1B45-0453-0505-1	114.5
330	531.8	88	9E-1B22-0425-0910-H09	67
330	531.8	88	9E-1B22-0425-0930-H11	67
340	629.5	55	9E-1B29-0500-90	74.6
340	629.5	55	9E-1B25-0500-90-1	79
359.2	550.2	50.6	9E-1B17-0451-0925	44.5
361.9	581.66	73	9E-1B22-0464-0602	69
382	595	65	9E-1B25-0474-0723	63
382	593	65	9E-1B25-0474-0523	62

Single-row

Boundary Dimensions			Designation	Weight
d	D	T		G
[mm]				[kg]
383	589.5	75	9E-1B32-0475-0470	58.5
386	483.7	40	9E-1B13-0418-0886	16
390	654	85	9E-1B35-0508-1230	94
392	492.2	41	9E-1B14-0422-1050	12.7
392	492.2	41	9E-1B14-0422-1050-1	12.7
412.8	643.5	95.3	9E-1B32-0521-1065	38.5
412.8	651.5	88.9	9E-1B32-0521-1120	107
412.8	651.5	88.9	9E-1B32-0521-0469	107
412.8	651.5	88.9	9E-1B32-0521-0469-1	107
412.8	651.5	88.9	9E-1B32-0521-1155	104
412.8	654	88.9	9E-1B32-0521-0746	107
412.8	654	88.9	9E-1B32-0521-0746-1	107
412.8	654	88.9	9E-1B32-0519-0486	113
412.8	654.1	88.9	9E-1B32-0521-1099	107
413	654	89	9E-1B30-0520-0500	108
428.6	638.8	56.3	9E-1B22-0543-0875	57.5
428.8	721.4	98.6	9E-1B45-0572-0522	166
428.8	759.1	92.2	9E-1B35-0560-0668	173
429.3	721.4	104.9	9E-1B45-0572-0956	159.5
431.8	721.4	87.38	9E-1B45-0559-0465	138
431.8	721.4	88.9	9E-1B40-0559-0390	141
431.8	721.4	88.9	9E-1B45-0559-0386	141.5
434	642	56	9E-1B21-0541-0598	42
434.1	638.8	55.9	9E-1B21-0525-1157	55.5
434.1	638.8	55.9	9E-1B20-0525-0894	53
435.1	721.4	87.4	9E-1B45-0561-0955	130
435.1	721.4	87.4	9E-1B45-0559-0348	145
435.1	721.4	87.4	9E-1B45-0559-0348-1	145
435.5	721.4	87.4	9E-1B40-0559-1004	139
442	541.6	40	9E-1B14-0472-0984	13.7
450.9	693.8	71.4	9E-1B25-0560-1056	91.5
465.1	667.7	57.1	9E-1B25-0559-0964	63.5
466.6	667.7	57.2	9E-1B25-0560-1005	64
468	683.26	70	9E-1B25-0569-0740	80
479	695	77	9E-1B32-0574-0576	77

## FOUR-POINT CONTACT BALL SLEWING RINGS – with external gear – special

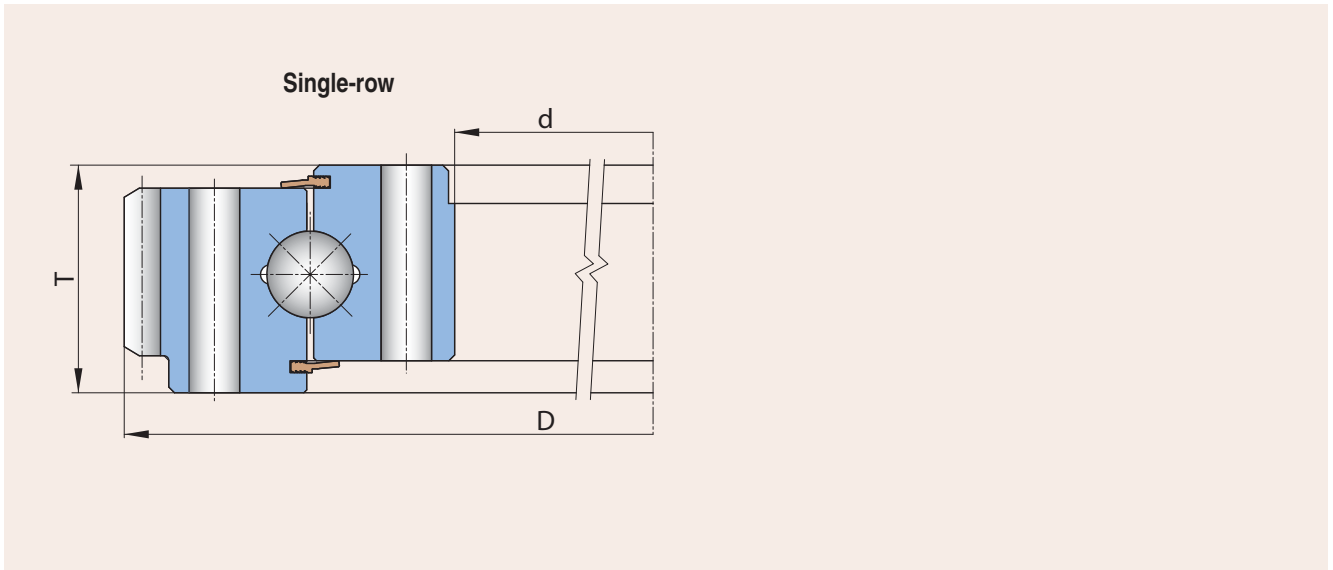

Single-row

Boundary Dimensions			Designation	Weight
d	D	T		G
[mm]				[kg]
479.6	708.7	82.6	9E-1B25-0584-0896	97
479.6	766.2	88.4	9E-1B45-0614-0453	150
479.6	766.3	88	9E-1B45-0614-0800	150
479.6	766.3	96.8	9E-1B45-0614-1226	152.5
479.6	766.4	88.9	9E-1B45-0614-0520	150
479.6	766.4	88.9	9E-1B45-0614-0520-1	150
479.6	766.4	88.9	9E-1B45-0614-1152	150
479.6	766.6	88.9	9E-1B45-0613-1084	142
479.6	766.6	88.9	9E-1B45-0613-1084-1	142
482.6	759.1	91.9	9E-1B40-0613-0948	143.5
482.6	759.1	92	9E-1B40-0613-0632-1	143
482.6	780	93.6	9E-1B35-0617-1002	147.5
494	604.7	54	9E-1B14-0537-1104	29.5
504	740	80	9E-1B30-0612-1356-SR10	107
526	804	101	9E-1B20-0629-0431	235
535	730	42.5	9E-1B20-0620-1091-HR01	48.5
587.5	784.5	55.6	9E-1B22-0676-0701	75
606.6	823	68	9E-1B25-0705-0662	93
606.6	823	68.3	9E-1B25-0705-0529	106
609.6	918.7	79.3	9E-1B38-0749-0526	167
609.6	918.7	90.4	9E-1B38-0749-0527	184
609.6	918.7	90.4	9E-1B38-0749-0739	184
609.6	918.7	90.4	9E-1B35-0749-0965	187
609.6	918.7	90.4	9E-1B35-0749-0965-1	187
616	860.6	88.9	9E-1B30-0727-0967	148
616	860.7	88.9	9E-1B32-0729-1011	144.5
616	860.7	88.9	9E-1B32-0727-0935	151
616	860.7	88.9	9E-1B32-0727-0939	152.5
619.3	860.7	92.2	9E-1B32-0725-1064	133
628.7	883.9	98.6	9E-1B32-0737-0803	170
634	835.7	55.9	9E-1B20-0733-0895	70.5
634	838.8	56	9E-1B20-0744-0448	53.5
634	838.8	56	9E-1B20-0744-0568	70.5
634	838.8	56	9E-1B20-0744-0568-1	70.5
634	838.8	56	9E-1B20-0744-0568-2	70.5

Single-row

Boundary Dimensions			Designation	Weight
d	D	T		G
[mm]				[kg]
654	899.2	75	9E-1B32-0762-0676	127
667	888	69	9E-1B25-0762-0846	107
690	938	76	9E-1B25-0832-1312	140
708.2	981.7	125.5	9E-1B45-0850-0747	257
711	1004	84.1	9E-1B40-0838-0734	204
711.2	1004	84.1	9E-1B35-0838-0691	204
711.2	1004	84.1	9E-1B35-0838-0758	204
711.2	1004	84.1	9E-1B40-0838-0759	204
714.2	987.2	125.5	9E-1B45-0857-1051	270
714.2	1011.7	101.8	9E-1B45-0854-1103	231
714.3	981.7	125.5	9E-1B45-0857-0336	259
714.3	981.7	125.5	9E-1B45-0857-0336-1	259
714.3	981.7	125.5	9E-1B45-0857-0347	265
714.4	981.7	125.4	9E-1B45-0857-0407	272
717.6	981.7	125	9E-1B45-0854-0343	253
724	952	76	9E-1B25-0812-1248	113
729.2	1021	187.5	9E-1B50-0876-0617	297
734	944.9	55.9	9E-1B20-0844-0585	70
734	944.9	55.9	9E-1B20-0844-0585-1	70
739.7	994.4	79.8	9E-1B35-0854-0663	344
749.3	984.25	98.6	9E-1B32-0868-0705	170
749.3	981.7	98.6	9E-1B32-0868-0705-1	170
752.35	1011.7	82.5	9E-1B40-0867-0466	165
752.35	1011.7	82.5	9E-1B40-0867-0466-1	174
755	915	52	9E-1B16-0825-1061B04	62.5
778	1102	80	9E-1B40-0910-1208	202.5
806.5	1108.71	125.4	9E-1B45-0947-0484	280
806.5	1150.6	125.5	9E-1B45-0947-0561	370
809.8	1155.7	101.6	9E-1B40-0975-1148	314
809.8	1155.7	107.95	9E-1B57-0976-0675	396
812.8	1137.9	108	9E-1B40-0959-0997	307
812.8	1137.9	108	9E-1B40-0959-1028	307
812.8	1072.9	141	9E-1B32-0924-1325	248
828.6	1088.64	86.6	9E-1B38-0940-0692	180
828.6	1088.64	86.6	9E-1B38-0940-0692-1	180

Single-row

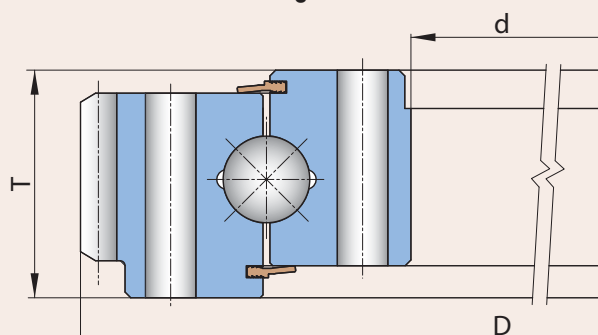

Single-row

Boundary Dimensions			Designation	Weight
d	D	T		G
[mm]				[kg]
834	1048	56	9E-1B20-0944-0774	68
834	1048	55	9E-1B20-0944-0567	89
853.9	1088.8	165.1	9E-1B45-0971-0671	268
853.9	1088.8	165.1	9E-1B45-0971-0671-1	268
870	1178.6	125.5	9E-1B45-1019-0736	375
882.6	1104.9	111	9E-1B25-0974-1188	195
882.6	1097.3	83.3	9E-1B25-0974-1207	165
882.6	1078.4	82	9E-1B25-0974-0625	148
882.6	1078.4	82	9E-1B25-0974-1054	148
889	1082.8	82	9E-1B25-0984-0451	147.5
889	1083	82	9E-1B25-0984-0572	135
893	1079	90	9E-1B20-0969-0213	150
895	1078	100	9E-1B25-0984-0445	140
914.4	1049.7	45.7	9E-1B13-0987-0754	53
938.5	1341.1	120.7	9E-1B50-1113-1076	509.5
955	1324	137	9E-1B45-1105-0329-1	480
958.9	1286.3	101.6	9E-1B45-1108-1078	337
960	1216.7	80	9E-1B30-1072-0836	208
960	1232	70	9E-1B35-1095-0788	215
975	1235.39	93	9E-1B40-1090-0637	253
976	1200	65	9E-1B25-1072-0833	135
976	1200	65	9E-1B25-1072-0833-1	135
976	1200	110	9E-1B35-1077-0542	238
984	1190.5	55.88	9E-1B20-1094-1062	77
984	1200	56	9E-1B20-1094-1404	85
990.6	1397	120.7	9E-1B60-1165-0738	535
990.6	1397	120.7	9E-1B60-1165-0738-1	535
1000.8	1280.16	89	9E-1B40-1121-1106	300
1057.2	1391.92	155.45	9E-1B57-1223-0344	553
1063.8	1388.5	130.05	9E-1B45-1209-0468	422
1068	1326.4	90	9E-1B30-1179-0749	221
1073.2	1366.5	130	9E-1B45-1209-0959	352
1085	1408	112	9E-1B35-1222-0708	394
1095	1380	110	9E-1B40-1212-0478	348
1100	1379.8	102	9E-1B35-1215-0640	312

Single-row

Boundary Dimensions			Designation	Weight
d	D	T		G
[mm]				[kg]
1104.9	1366.5	130	9E-1B45-1209-0737	386
1104.9	1366.5	130	9E-1B45-1209-0769	384
1107	1400	88.5	9E-1B30-1250-1146	233
1110	1520.8	180	9E-1B70-1303-0962	817
1122	1367.5	85	9E-1B22-1235-0771	234
1150	1410.16	93	9E-1B40-1265-0551	265
1165	1428.26	104	9E-1B35-1288-0829	248
1208	1498.6	89	9E-1B32-1320-0215	298
1230	1456	80	9E-1B25-1330-0233	240
1231.2	1604	118.1	9E-1B50-1390-0728	535
1305.1	1591.1	89.9	9E-1B30-1455-1043	250
1323.8	1752.6	146.1	9E-1B70-1512-1384	913
1337	1704	120	9E-1B45-1490-0891	564
1350	1458	95	9E-1B16-1389-0690	145
1374.7	1903.3	142.9	9E-1B70-1597-0784	1202
1383.3	1905	171.5	9E-1B75-1638-0807	1310
1520	1782.33	80	9E-1B30-1643-0826	318
1524	1761.1	58.4	9E-1B22-1632-0711	209
1540	1915	119.9	9E-1B50-1700-1033	376.5
1546.2	1849.1	76.2	9E-1B40-1676-0494	406
1546.2	1849.1	76.2	9E-1B35-1676-1163	396
1546.2	1849.5	127	9E-1B35-1676-1133	558
1600	2010.4	138	9E-1B50-1767-1001	920
1660	2097.6	120	9E-1B60-1850-1007	900
1686	2034	120	9E-1B45-1848-0904	682
1695.5	2160.7	180.85	9E-1B75-1897-0783	1575
1729	2139.2	100	9E-1B45-1900-1009	698
1740	2000	73	9E-1B25-1830-1241	315
1835	2093.26	93	9E-1B40-1942-0638	427
1880	2193.64	114	9E-1B40-2030-0865	567
1952	2214.8	80	9E-1B35-2074-1090	400
1957	2380.8	109	9E-1B50-2130-0892	940
1957	2380.8	109	9E-1B50-2130-0636	940
2010	2267.4	90	9E-1B40-2122-1145	473
2115	2457.6	120	9E-1B45-2253-1307	822





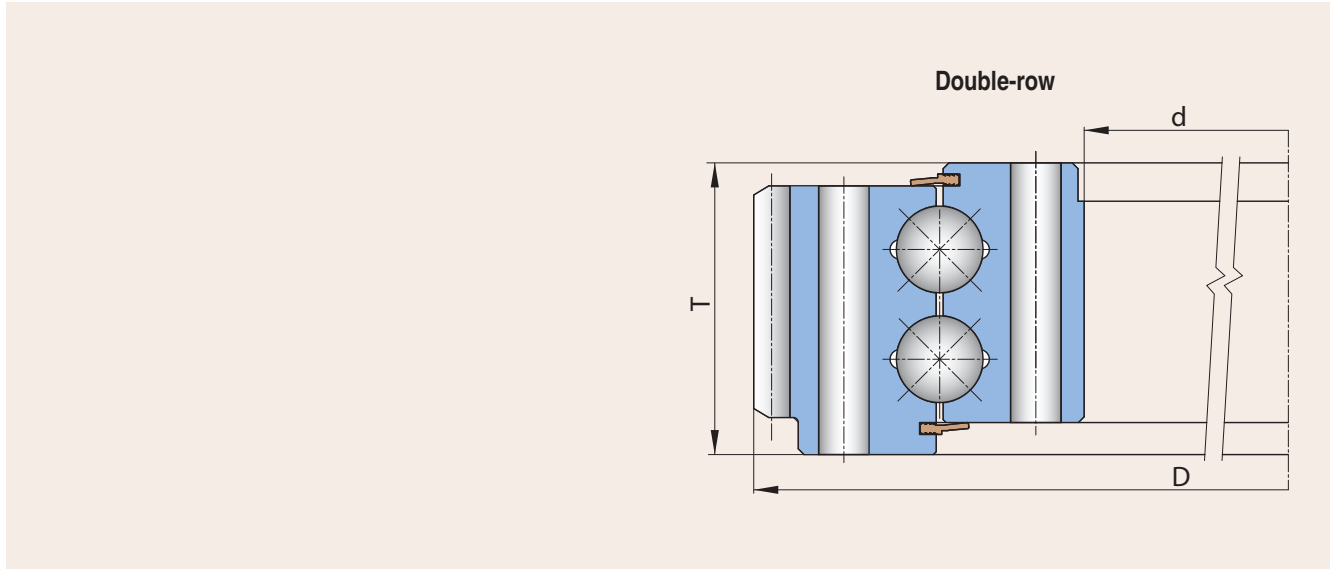

**Double-row**



Boundary Dimensions			Designation	Weight
d	D	T		G
[mm]				[kg]
260.3	343	84.1	9E-2B20-0343-1081	48
260.3	434	84.1	9E-2B16-0343-0764	48
330	531.8	88	9E-2B22-0425-0888-H10	75
330	531.8	88	9E-2B22-0425-1024-H12	72
895	1077.7	100	9E-2B25-0976-1023	165
895	1079.1	82	9E-2B20-0971-0112	130
1625.1	1905.7	137.9	9E-2B30-1735-0988	582
1630	2112	153	9E-2B32-1810-1348	1240
1686	2044	165.86	9E-2B40-1835-0776	945
1773	2039.7	126	9E-2B25-1877-0987	510
1773	2040	126	9E-2B25-1876-1302	525
1819	2226	224	9E-2B50-1993-1344	1506
2200	2880	290	9E-2B60-2500-1095	4158

## FOUR-POINT CONTACT BALL SLEWING RINGS – with internal gear

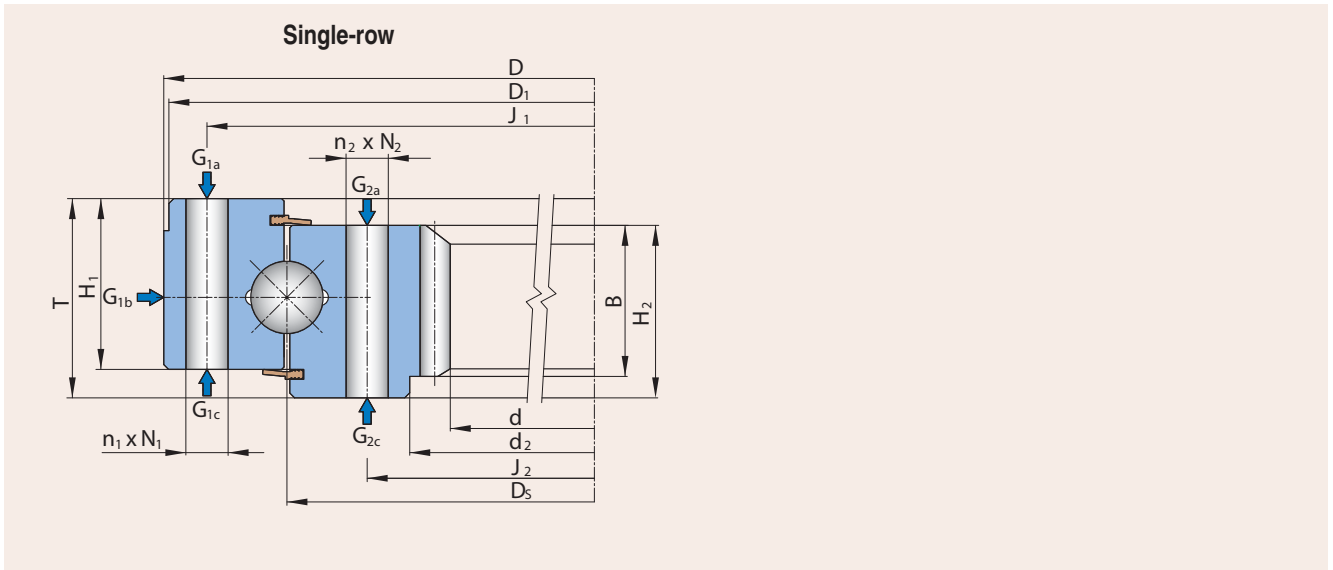

### Single-row

Boundary Dimensions			Designation	Weight G	Abutment Dimensions				Mounting Holes $N_1$		Mounting Holes $N_2$	
d	D	T			$J_1$	$J_2$	$N_1$	$N_2$	Number $n_1$	Hole Type	Number $n_2$	Hole Type
[mm]				[kg]	[mm]							
638.4	914.4	88.9	9I-1B32-0788-1283	170	863.6	717.6	1-8 UNC	1-8 UNC	32	C	40	D
648.2	851	70	9I-1B25-0763-0186	89	820	705	M16	M16	24	E	24	E
650.2	848.4	55.9	9I-1B20-0741-0400	82	812.8	701.8	17.5	1/2-13 UNC	15	A	28	D
650.6	914.4	88.9	9I-1B32-0788-0950	176	863.6	717.6	24	7/8-9 UNC	16	A	20	D
656	868	77	9I-1B22-0783-0444	104	834	730	18	M16	18	A	24	E
670.6	933.5	98	9I-1B32-0813-0952	180.5	889	741.4	27	1-8 UNC	24	A	26	D
670.6	933.5	98	9I-1B32-0813-0951	181	889	741.4	24	7/8-9 UNC	24	A	26	D
670.6	950	98.6	9I-1B35-0825-1077	203.5	899.2	749.3	1-8 UNC	27	24	C	36	A
670.6	950	98.6	9I-1B35-0825-1077-1	203.5	899.2	749.3	27	1-8 UNC	24	A	36	C
736	950	70	9I-1B25-0860-0157	105	920	805	M16	M16	30	E	30	E
736	950	70	9I-1B25-0860-0157-1	105	920	805	M16	M16	30	E	30	E
757.6	1143	104.9	9I-1B50-0970-1166	356	1092.2	850.9	30	30	30	A	42	A
770.1	1054.1	106.5	9I-1B40-0923-0713	247	1016	850.9	24	7/8-14 UNF	36	A	36	D
772.7	1003.3	127	9I-1B32-0897-1185	222	944.1	849.9	7/8-9 UNC	7/8-9 UNC	36	D	36	D
786.5	990.6	114.3	9I-1B32-0897-0198	170	944.1	849.9	3/4-10 UNC	3/4-10 UNC	30	D	30	D
856	1066	75	9I-1B25-0980-1052	143	1035	926	18	M16	24	A	26	E
861.4	1101.8	90	9I-1B30-0995-0558	194	1060	930	M20	M20	24	C	24	D
945.4	1200	100	9I-1B29-1103-0323	240	1165	1040	21.5	M20x1.5	36	A	36	D
954	1185	75	9I-1B22-1090-0832	143	1145	1045	18	M16	40	A	40	D
957.1	1174.8	108	9I-1B32-1088-0689	213	1134.1	1039.9	3/4-10 UNC	3/4-10 UNC	36	D	36	D
957.1	1168.4	119.4	9I-1B40-1086-0450	210	1134.1	1039.9	3/4-10 UNC	3/4-10 UNC	36	D	36	D
957.1	1168.4	119.4	9I-1B40-1086-0450-1	212.5	1134.1	1039.9	3/4-10 UNC	3/4-10 UNC	36	D	36	D
963	1195	85	9I-1B30-1099-1114	179	1180	1040	19	17	36	A	36	A
986.4	1256	102	9I-1B30-1150-1126	274	1215	1085	22	M20	30	A	30	F
1000	1298	90	9I-1B35-1170-1266	282	1250	1095	26	M20	22	A	30	F
1007.9	1298.5	90.4	9I-1B32-1167-0504	282	1247.8	1092.2	27	1-8 UNC	22	A	20	D
1008.3	1298	90	9I-1B35-1170-1190	280	1250	1095	26	M20	22	A	30	F
1015	1213	66	9I-1B20-1131-0552	125	1181	1081	M16	18	40	E	40	A
1019.2	1381.1	127	9I-1B40-1241-1341	498	1333.5	1149.4	26	M24	30	A	30	E
1046	1399.5	114.3	9I-1B45-1257-1041	456	1342.4	1170.7	24	24	30	A	36	B
1048.5	1320.8	128.52	9I-1B45-1187-0352	349	1279.5	1130.2	23.9	7/8-9 UNC	36	A	40	D
1048.5	1358.9	114.3	9I-1B50-1234-0327	401	1317.6	1149.4	7/8-9 UNC	7/8-9 UNC	36	D	36	D
1060.7	1339.9	121.4	9I-1B40-1204-0197	354	1295.4	1149.4	27	1-8 UNC	30	A	30	D
1071	1305	98	9I-1B32-1200-0392	245	1265	1156	21	M16	48	A	48	D
1075.1	1300	110	9I-1B30-1205-0251	240	1270	1170	21	M20	(36-1)	A	36	D

### Mounting holes types

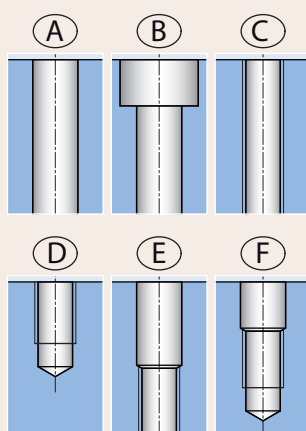

### Lubrication spots types

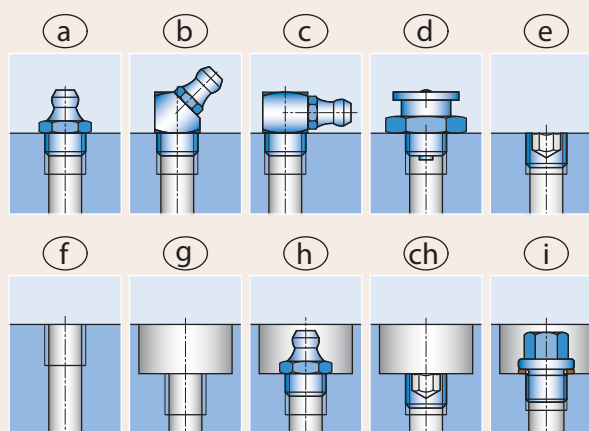

Other Specifications								Permissible Circumferential Force		Lubrication Spots				Note No.	Notes
D <sub>1</sub>	d <sub>2</sub>	H <sub>1</sub>	H <sub>2</sub>	B	m (DP)	z	x	F <sub>TDoV</sub>	F <sub>Tmax</sub>	Type	Size	Location	Number		
[mm]								[kN]							
-	-	76.2	82.6	82.6	DP3	77	0	75	150	a	1/8-27 NPT	G1b	1		1 – Thread in mounting holes has a depth of 30
850	-	55	60	55	6	109	-0.5	38	76	f	M10x1	G1b	2		2 – The inner ring piloted on the outer diameter
-	-	45.7	45.7	45.7	DP4	104	0	20	40	f	1/8-27 NPT	G1b	2		3 – The outer ring piloted on the inner diameter
-	-	76.2	82.6	82.6	DP4/5	104	0	57	114	a	1/8-27 NPT	G1b	1		4 – Mounting holes on the inner ring are regular
-	-	55	68	64	8	82	0	55	110	f	M10x1	G1b	4		
-	-	76.2	88.9	88.9	DP3.5	94	0	71	142	a	1/8-27 NPT	G1b	1		
-	-	76.2	88.9	88.9	DP3.5	94	0	71	142	a	1/8-27 NPT	G1b	1		
-	-	85.85	92.2	92.2	DP3.5	94	0	70	140	a	1/8-27 NPT	G1b	2		
-	-	85.85	92.2	92.2	DP3.5	94	0	70	140	a	1/8-27 NPT	G1b	2		
-	-	55	60	55	8	94	0	46	92	f	M10x1	G1a/G1b	2/2		
-	-	55	60	55	8	94	0	46	92	f	G 1/8	G1a	2		
-	-	92.2	98.5	98.5	DP3.5	106	0	78	156	a	1/8-27 NPT	G1b	2		
-	-	85.6	88.9	88.9	DP2.5	77	-0.4	81	162	f	Rp 1/8	G1b	4		
-	-	101.6	101.6	76.2	DP3.5	108	0	60	120	a	1/8-27 NPT	G1b	2		
-	820.4	85.9	90.4	50.8	DP3.5	110	0	46	92	g	1/8-27 NPT	G1b	4		
1065	-	70	65	50	4	216	0	16	32	a	AM10x1	G1b	4		
-	978.6	82	75	70	7	125	0	42	84	a	AM10x1	G1b	3		
-	-	80	83	82	12	80	0.1666	117	234	f	1/8-27 NPSF	G1b	3		
1084	-	48	65	65	9	106	-1.4	68	136	f	M10x1	G1b	4	2	
-	1010.9	85.9	95.3	69.9	DP2.5	96	0	75	150	a	1/8-27 NPT	G1b	4		
1165.4	-	46	46	55.1	DP2.5	96	0	59	118	g	1/8-27 NPT	G1b	4		
1165.4	-	46	46	63.5	DP2.5	96	0	68	136	g	1/8-27 NPT	G1b	4		
-	-	72	70	69	10	98	0	68	136	a	1/8-27 NPT	G1b	2		
1255	1132	96	85	79	12	84	0	101	202	a	AM10x1	G1b	5	2, 4	
-	1065	80	80	69	12	84	-0.5	96	192	a	AM10x1	G1b	2		
-	-	79.25	68.33	65.8	DP2.5	100	-0.4	84	168	a	1/8-27 NPT	G1b	2		
-	1065	80	75	64	10	101	-0.713	74	148	a	AM10x1	G1b	2		
1213	-	56	54	54	7	148	-0.5	38	76	a	AM10x1	G1b	4		
-	-	98.4	117.5	101.6	14	74	-0.4	154	308	f	1/8-27 NPT	G1b	2		
-	-	101.6	101.6	101.6	14	76	-0.357	134	268	g	1/8-27 NPT	G1b	4		
-	-	91.9	119.13	101.6	DP2.5	104	-0.4	129	258	a	1/8-27 NPT	G1b	2		
-	1104.9	102.9	114.3	76.2	DP2.5	105	0	80	160	g	1/8-27 NPT	G1b	4		
1336.6	-	98.552	104.902	76.2	DP2.5	106	0	67	134	a	1/8-27 NPT	G1b	2		
-	-	82	90	88	10	106	-1.549	102	204	g	M10x1	G1b	6		
-	-	80	90	80	12	90	-0.669	111	222	f	1/8-27 NPT	G1a/G1b	1/2		

## FOUR-POINT CONTACT BALL SLEWING RINGS – with internal gear

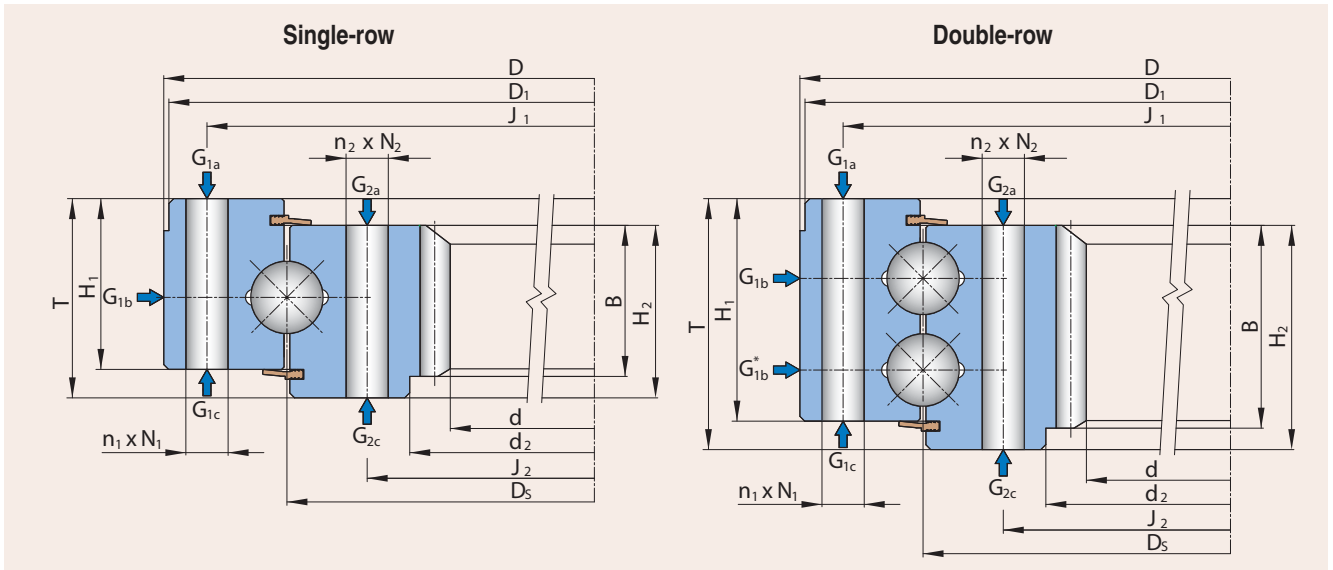

### Single-row

Boundary Dimensions			Designation	Weight G	Abutment Dimensions				Mounting Holes $N_1$		Mounting Holes $N_2$	
d	D	T			$J_1$	$J_2$	$N_1$	$N_2$	Number $n_1$	Hole Type	Number $n_2$	Hole Type
[mm]				[kg]	[mm]							
1078	1377	130	9I-1B40-1252-0364	416	1331	1191	26	M24	34	A	36	D
1080	1300	110	9I-1B30-1205-0644	225	1270	1170	21	M20	(36-1)	A	36	D
1080	1310	105.5	9I-1B30-1212-1117	224	1275	1146	21	M20x1.5	36	A	36	D
1083	1310	105	9I-1B40-1212-1116	223	1275	1170	21	M20x1.5	36	A	36	D
1085.3	1410	115	9I-1B40-1278-1269	418	1360	1195	26	26	40	A	40	A
1132.8	1402	80	9I-1B30-1280-0963	254	1358	1202	M20	22	24	D	24	B
1132.8	1402	80	9I-1B30-1280-1109	254	1358	1202	M20	22	24	D	24	B
1140.3	1404	112	9I-1B25-1296-0180	303	1360	1232	22	M20	48	A	48	E
1178	1530	130	9I-1B40-1385-0861	538	1480	1290	26	M24	48	A	48	E
1184	1427	88.9	9I-1B25-1321-0881	266	1390	1255	22	M20	18	B	18	D
1186.2	1524	139.7	9I-1B45-1378-0781	536	1473.2	1282.7	1-8 UNC	27	36	E	36	A
1188	1530	130	9I-1B40-1385-0860	517	1480	1290	32	M30	36	A	48	E
1191.1	1565.1	133.4	9I-1B50-1416-0985	599	1517.7	1314.5	27	27	42	A	42	A
1231	1630	130	9I-1B50-1466-0994	678	1578	1360	32	M30x2	36	A	40	D
1324.4	1725	134	9I-1B50-1559-1297	688	1666	1452	30	30	(60-1)	A	60	A
1314.7	1600	89.9	9I-1B30-1455-1389	311	1562.1	1397	3/4-10 UNC	3/4-10 UNC	48	D	48	D
1328.9	1708.2	120.7	9I-1B45-1561-1040	661	1651	1470	24	24	36	A	36	B
1452	1900	130	9I-1B50-1722-1311	903	1835	1610	32	32	48	A	48	A
1610	2000	150	9I-1B60-1830-0267	925	1940	1720	30	30	54	A	54	A
1619	2025	140	9I-1B45-1864-0859	880	1970	1760	35	M33	(54-1)	A	54	E
1788	2240	137	9I-1B60-2045-1353	1172	2170	1920	33	33	45	A	45	A
1846	2250	110	9I-1B50-2070-1111	867	2180	1960	32	32	48	A	48	A
2243	2661	126	9I-1B45-2490-0907	1225	2595	2385	33	M30	54	A	54	E
2243	2661	126	9I-1B45-2490-0907-1	1225	2595	2385	33	M30	72	A	72	E

### Double-row

786.7	973.1	82	9I-2B20-0896-1129	125.5	944	850	5/8-11 UNC	5/8-11 UNC	30	E	30	D
786	973	97	9I-2B20-0897-1277	151.5	944	850	17.5	17.5	36	A	36	A
978.5	1251	109	9I-2B25-1139-1386	320	1211	1067	22	M20	36	A	36	E
1418.4	1750	120	9I-2B30-1615-1234	574	1705	1525	25	25	40	B	40	B
1764.5	2115	120	9I-2B30-1995-1085	745	2070	1890	26	26	48	A	48	A

### Mounting holes types

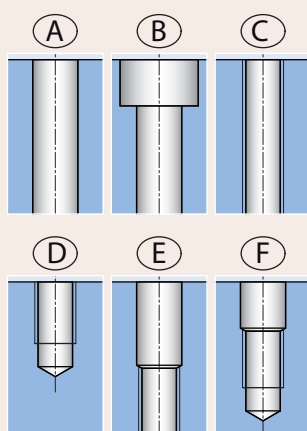

### Lubrication spots types

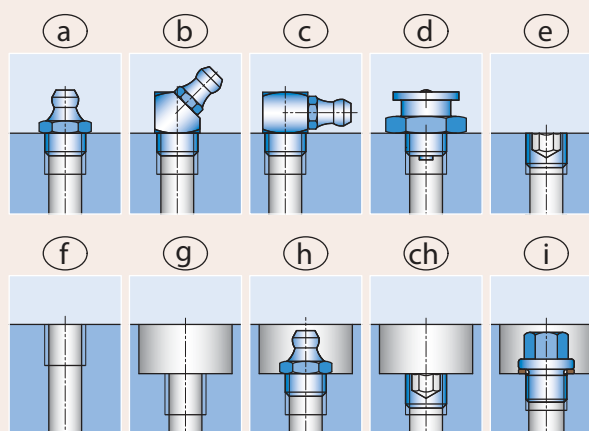

Other Specifications								Permissible Circumferential Force		Lubrication Spots				Note No.	Notes
D <sub>1</sub>	d <sub>2</sub>	H <sub>1</sub>	H <sub>2</sub>	B	m (DP)	z	x	F <sub>TDoV</sub>	F <sub>Tmax</sub>	Type	Size	Location	Number		
[mm]								[kN]							
1377	-	85.1	119.9	110	14	78	-0.5	178	356	f	1/8-28 BSP	G1b	4		1 – Thread in mounting holes has a depth of 30
-	1142	80	90	80	10	110	0	83	166	a	1/8-27 NPT	G1b	3		2 – The inner ring piloted on the outer diameter
1213.5	-	70.5	95	94.5	12	92	0	114	228	h	AM10x1.5	G1b	2	3	3 – The outer ring piloted on the inner diameter
-	-	75	95	94.5	12	92	0	114	228	a	A R1/8	G1b	2		4 – Mounting holes on the inner ring are regular
-	-	94	106	100	8	137	-0.3	85	170	a	AM10x1	G1b	5		
1283	-	70	70	51	DP4/5	180	0	32	64	a	1/8-27 NPT	G1b	6	3	
1283	-	70	70	51	DP4/5	180	0	39	78	a	1/8-27 NPT	G1b	6	3	
-	1297	70	103	102.5	10	115	-0.5	119	238	f	M10x1	G1b	6	2	
-	-	107	107	100	12	100	0	125	250	g	M10x1	G1b	4		
1425	1321	80	80	70.1	8	150	0	47	94	h	AM10x1	G1b	6	2	
1521	-	114.3	114.3	82.6	12.7	95	0	110	220	a	1/8-27 NPT	G1b	2		
-	-	107	107	90	10	120	-0.3	92	184	f	M10x1	G1b	4		
-	-	114.3	108	108	DP1.75	83	-0.375	176	352	a	1/8-27 NPT	G1b	4		
1625	1305.6	110	120	115	16	78	-0.3	198	396	a	AM10x1	G1b	4		
-	-	100	125	125	14	96	-0.3	184	368	a	AM10x1	G1b	5		
-	-	71.1	71.1	71.1	DP2.5	131	0	73	146	a	1/8-27 NPT	G1b	6		
-	-	101.8	108	95.3	14	96	-0.459	122	244	a	1/8-27 NPT	G1b	4		
1900	-	113	114	114	12	122	-0.5	132	264	a	AM10x1	G1b	6		
2000	1665	125	125	100	12	135	-0.5	139	278	g	M10x1	G1b	6		
-	-	118	118	115	16	101	-1	224	448	f	M10x1	G1b	6		
-	-	124	119	119	12	150	-0.3	144	288	a	AM10x1	G1b	5		
-	-	100	100	100	12	155	-0.3	120	240	h	AM10x1	G1b	6		
-	-	105	117	117	16	141	-0.5	217	434	f	M10x1	G1b	9		
-	-	105	117	117	16	141	-0.5	217	434	f	M10x1	G1b	9		
-	-	78	71	50	DP3.5	110	0	35	70	a	1/8-27 NPT	G1b/G1b*	2/2		
-	-	88	88	88	8	99	-0.5	81	162	a	AM8x1	G1b/G1b*	2/2		
1250	-	100	96	91.5	10	99	-0.35	96	192	f	M10x1	G1b/G1b*	4/4		
-	-	110.5	110.5	98.5	12	120	0	101	202	a	1/8-27 NPT	G1b/G1b*	5/5		
-	1972	114	100	99	14	127	-0.5	134	268	g	M10x1	G1b/G1b*	4/4	2	

## FOUR-POINT CONTACT BALL SLEWING RINGS – with internal gear – special

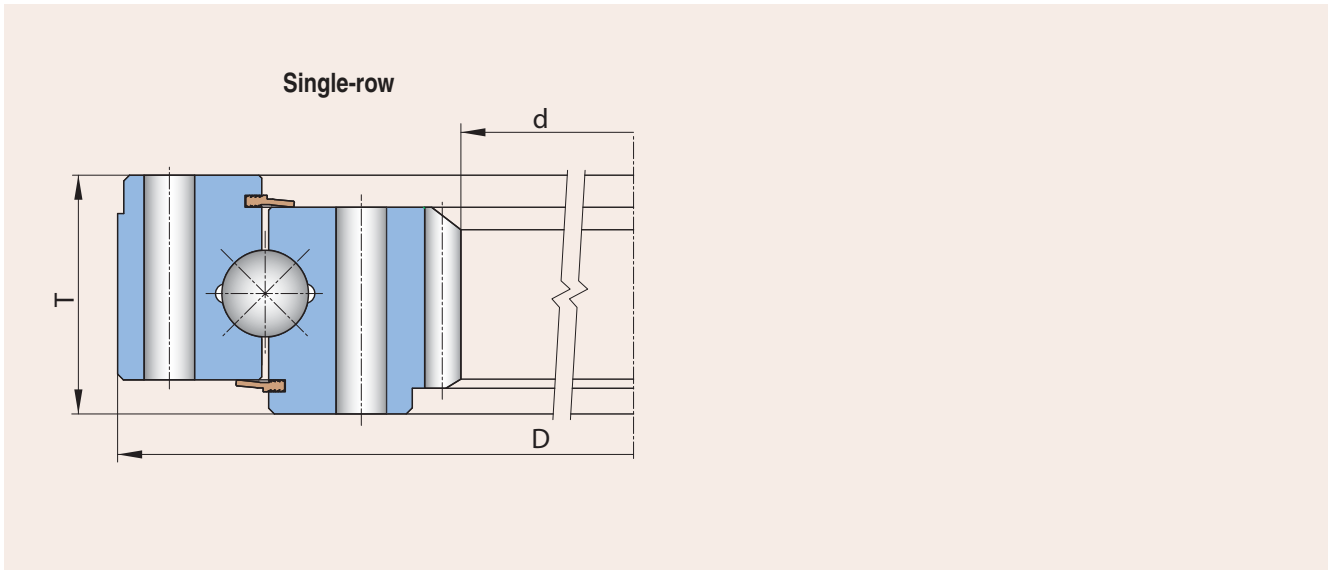

Single-row

Boundary Dimensions			Designation	Weight
d	D	T		G
[mm]				[kg]
216	340	39	9I-1B16-0288-0908	13
216	340	42	9I-1B16-0288-1035	13
258.95	418	50	9I-1B20-0342-0351-1	25
258.95	418	50	9I-1B20-0342-0351-2	25
292	457	48	9I-1B20-0388-1034-1	30.5
315.5	520.5	54	9I-1B25-0422-1030	49
319.5	458	37	9I-1B16-0400-1393	17
319.5	458	37	9I-1B16-0400-0724	18
320	458	37	9I-1B16-0400-0610	17.5
323.8	520.3	54	9I-1B25-0422-0283-2	46
323.8	520.3	54	9I-1B25-0422-0283-1	46
323.8	520.3	54	9I-1B25-0422-0283-3	46
323.8	520.3	54	9I-1B25-0422-0616	46
323.9	520.7	55.6	9I-1B25-0421-0893-1	46.5
323.9	520.7	55.6	9I-1B25-0421-0893-2	46.5
323.9	520.7	55.6	9I-1B25-0422-1202	48.5
332	486	39	9I-1B16-0420-0909	23
379	535	50	9I-1B20-0465-0725	33
379	535	50	9I-1B20-0465-1059	33
379	535	50	9I-1B20-0465-0133-1	34
380	535	50	9I-1B20-0465-0133	34
380	545	55	9I-1B20-0465-0136-1	37
428	660.4	69.85	9I-1B25-0559-0847	80
445	648	56	9I-1B20-0541-0591	39
445.5	645	60	9I-1B25-0550-0743	57.5
462	651	65	9I-1B25-0570-0221	62
472	640	55	9I-1B22-0566-0726	44
480	640	55	9I-1B22-0566-0726-1	44
492.3	690	70	9I-1B25-0604-1390	70
516.9	789	120.7	9I-1B40-0665-0795	224
542.3	730.3	88.9	9I-1B25-0635-0760	100
546	748	56	9I-1B20-0641-0629	46
548.6	730.5	51.5	9I-1B25-0657-0562	53
548.8	724	45	9I-1B20-0658-1032	46.5
560	825	90	9I-1B36-0715-0254	139

Single-row

Boundary Dimensions			Designation	Weight
d	D	T		G
[mm]				[kg]
585	810	85	9I-1B25-0720-0190	108
593.8	850	80	9I-1B32-0740-1074	136
600	660	58	9I-1B10-0630-0333	20.5
648	850	70	9I-1B25-0763-0158	85
648	850	70	9I-1B25-0763-0158-1	85
650.2	848	56	9I-1B20-0741-0279JUA	54.8
650.2	848	56	9I-1B20-0741-0279	54.8
650.2	848.1	55.9	9I-1B20-0756-1031	72.5
650.2	848.1	55.9	9I-1B20-0756-0848	72
650.2	848.1	55.9	9I-1B20-0748-1281	53.5
650.2	853.9	55.9	9I-1B22-0762-1131	76.5
650.6	914.4	88.9	9I-1B32-0788-0915	176.5
669.3	857.3	88.9	9I-1B25-0762-1135	112
670	856.99	88.9	9I-1B25-0762-0391	120
670	857	88.9	9I-1B25-0762-0391-1	120
670.6	933.5	101.6	9I-1B32-0813-0953	178
694.9	1035.1	114.3	9I-1B45-0887-0957	292
709	900	80	9I-1B25-0782-0679	112
736	950	70	9I-1B25-0860-0157-2	105
740	950	58.7	9I-1B25-0848-0934	98.5
740	1000	80	9I-1B32-0902-1112	177
745.7	990.6	101.6	9I-1B32-0883-0944	187.5
762	934	80	9I-1B22-0862-1118	240
782.3	1000.3	88.9	9I-1B25-0889-1066	151.5
785	980	68	9I-1B20-0892-0581	98
785	980	68	9I-1B20-0892-0580	98
786.7	990.6	114.3	9I-1B35-0895-0415	168
786.7	990.6	114.3	9I-1B35-0897-0633	165
790	1041.7	65.1	9I-1B32-0924-0512	135
790	1041.7	65.1	9I-1B32-0924-0512-1	135
820	1145	92	9I-1B30-1050-0375	187
840	1048	56	9I-1B20-0941-0615	69
840	1065	56	9I-1B20-0950-0748	106.5
841.6	1048	56	9I-1B20-0941-1388	68
843	1048	55.9	9I-1B20-0956-1010	93

Single-row

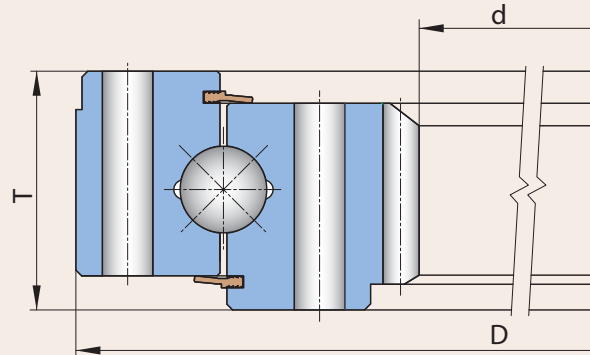

Single-row

Boundary Dimensions			Designation	Weight G
d	D	T		
[mm]				[kg]
854	1066	102	91-1B25-0978-1127	177.5
856.3	1084	89	91-1B30-0990-0296	152
864	1084	73	91-1B30-0990-0169	133
881.5	1116	75	91-1B25-1014-0250	155
881.5	1116	75	91-1B25-1014-0302	155
881.5	1116	75	91-1B25-1014-0302-1	155
900	960	58	91-1B10-0930-0312	28
920	1145	92	91-1B30-1050-0275	159
920	1145	92	91-1B30-1050-0334	180
924	1225.5	125	91-1B40-1086-1296	372
924.6	1226.3	101.6	91-1B40-1094-0936	292.5
924.6	1225.5	101	91-1B35-1096-1093	293
935	1202	130	91-1B40-1080-0623	296
939.6	1215	115	91-1B35-1085-0672-1	267
944	1159	79	91-1B25-1065-0134	150
945.4	1200	81	91-1B29-1103-0827	240
945.4	1200	100	91-1B29-1103-0323-1	240
945.4	1200	100	91-1B29-1103-0323-2	240
950.1	1250	84	91-1B35-1140-1294	269
955	1177	90	91-1B30-1070-0372	181
957.1	1163.3	89.9	91-1B32-1087-0353	173
957.1	1163.5	100	91-1B32-1087-0413	188
957.1	1168.4	100	91-1B32-1087-0421	190
959.1	1200.2	100	91-1B25-1096-1027	205
961.2	1205	95	91-1B30-1094-0314	224
963	1200	90	91-1B30-1100-0114	216
967.2	1222.3	127	91-1B40-1090-0339	305
967.2	1222.2	177.8	91-1B40-1092-1119	292
971.6	1172	85.34	91-1B22-1086-0459	145
984	1166	56	91-1B20-1098-1331	87
1000	1298	90	91-1B35-1170-1266-1	282
1007.8	1298	90	91-1B35-1170-1306	275
1008.3	1298	90	91-1B35-1170-1190-1	280
1009.9	1298.5	101.6	91-1B32-1167-0382	308
1010	1298.7	108.4	91-1B40-1165-0495	328

Single-row

Boundary Dimensions			Designation	Weight G
d	D	T		
[mm]				[kg]
1027	1328	120	91-1B35-1194-0837	389
1038	1450.9	104.6	91-1B40-1250-0358	413
1038	1450.9	104.6	91-1B40-1250-0358-1	413
1048.5	1320.8	128.5	91-1B45-1187-0352-1	349
1048.5	1320.8	128.5	91-1B45-1187-1367	349
1048.5	1320.8	128.6	91-1B45-1187-1222	370.5
1048.5	1358.9	114.3	91-1B50-1234-0327-1	403.5
1048.5	1381.3	127	91-1B45-1240-0506	448
1048.5	1381.3	127	91-1B45-1240-0464	465
1048.5	1381.3	127	91-1B45-1240-0464-1	451.5
1054.1	1301.8	103.1	91-1B25-1200-1176	263
1066.8	1398	200	91-1B50-1221-0745	474
1071	1305	98	91-1B31-1200-0140	264
1071	1305	98	91-1B32-1200-0140-1	245
1083	1322.1	99.6	91-1B30-1202-0641	248
1083	1322.1	99.6	91-1B30-1202-0641-1	248
1083	1327	110	91-1B32-1220-0546	246
1083	1526	121.9	91-1B35-1405-0687	698
1083.6	1310	110	91-1B29-1213-0324	243
1092	1360	125	91-1B32-1243-0369	325
1092	1379	122.5	91-1B40-1249-0782	397
1092.2	1400	90	91-1B40-1278-1292	327
1092.2	1400	92	91-1B40-1278-1323	332
1137.9	1456	203.2	91-1B50-1289-0647	507
1140	1404	99	91-1B25-1296-0141	272
1140	1404	99	91-1B25-1296-0222	280
1150.1	1514.4	206.3	91-1B60-1336-1352	670
1164	1515	135	91-1B45-1362-0613	545
1164.2	1495	110	91-1B40-1350-0483	428
1164.2	1495	110	91-1B40-1350-0483-1	428
1176	1460	120	91-1B35-1340-0889	390
1182	1464.6	135.1	91-1B35-1344-0368	380
1212	1489	119.9	91-1B30-1375-0712	378
1212	1600	115	91-1B40-1446-1102	594
1218	1600	112	91-1B45-1448-1293	532

## FOUR-POINT CONTACT BALL SLEWING RINGS – with internal gear – special

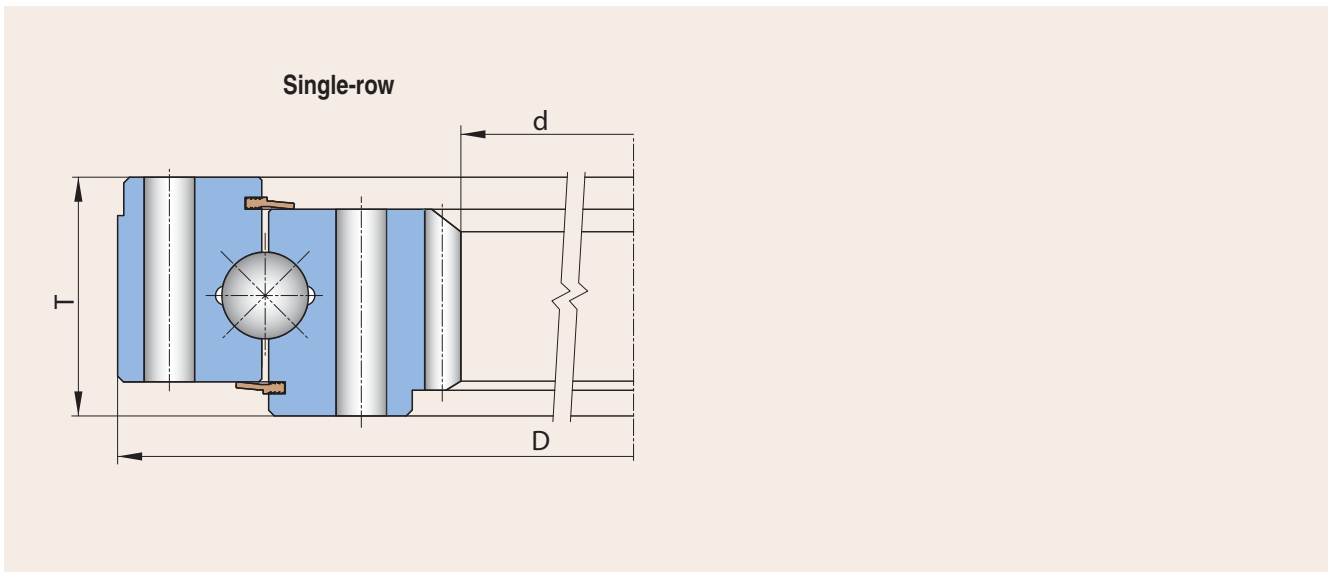

Single-row

Boundary Dimensions			Designation	Weight
d	D	T		G
[mm]				[kg]
1220	1620	150	9I-1B60-1440-0612	780
1225	1460	120	9I-1B38-1340-0325	402
1231.2	1592.1	200	9I-1B57-1411-0697	703
1235	1532	125	9I-1B40-1405-0685	429
1235.2	1526	121.9	9I-1B35-1405-0686	445
1238	1563	151.9	9I-1B50-1405-0688	618
1239.9	1602.6	133.4	9I-1B50-1470-0203	653
1251.5	1592.1	200	9I-1B50-1419-0648	582
1262	1549.4	145	9I-1B40-1420-0365	465
1262	1575.6	150	9I-1B40-1420-0835	522
1358.4	1648	209.8	9I-1B45-1505-0878	529
1364	1770	120	9I-1B50-1594-1263	712
1473.2	1797.1	123.8	9I-1B32-1676-0801	569
1473.2	1797.1	123.8	9I-1B32-1676-0801-1	569
1496.9	1797.1	124	9I-1B35-1676-0855	503
1680	2000	88.9	9I-1B35-1877-1136	498.5
1837	2330	145	9I-1B60-2138-1080	1294
1998.1	2324.1	139.7	9I-1B40-2184-0901	810
2064	2500	145	9I-1B50-2320-1008	1314
2064	2500	144	9I-1B50-2320-1008-1	1314
2064	2500	144	9I-1B50-2320-1008-2	1290
2064	2500	145	9I-1B50-2320-1008-3	1314
2358	2680	108	9I-1B45-2515-0903	822
2715	3250	172	9I-1B60-3000-1245	2476
2715	3250	172	9I-1B60-3000-1326	2476

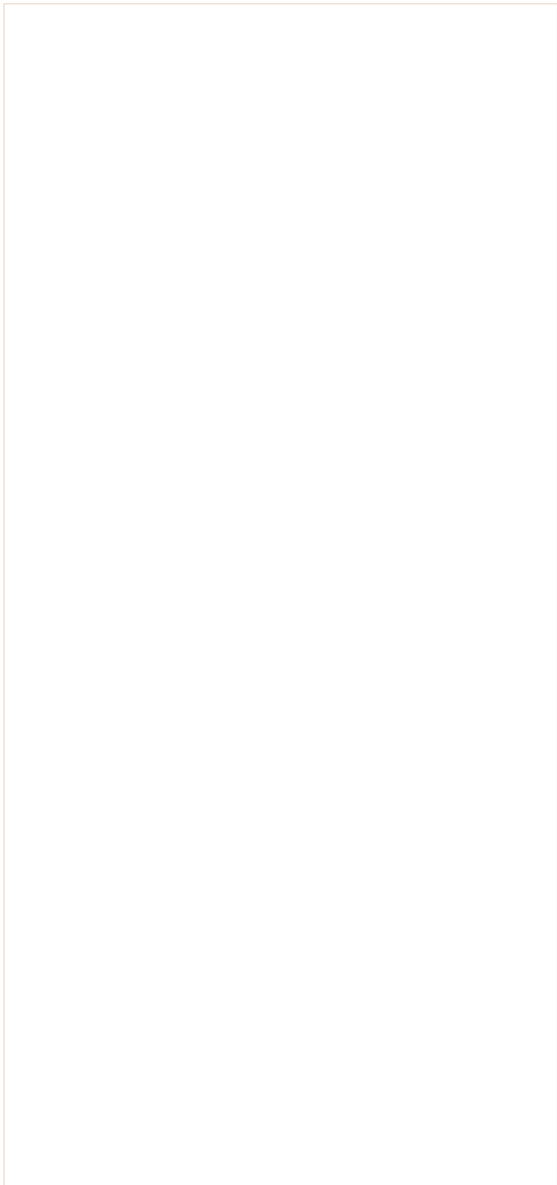



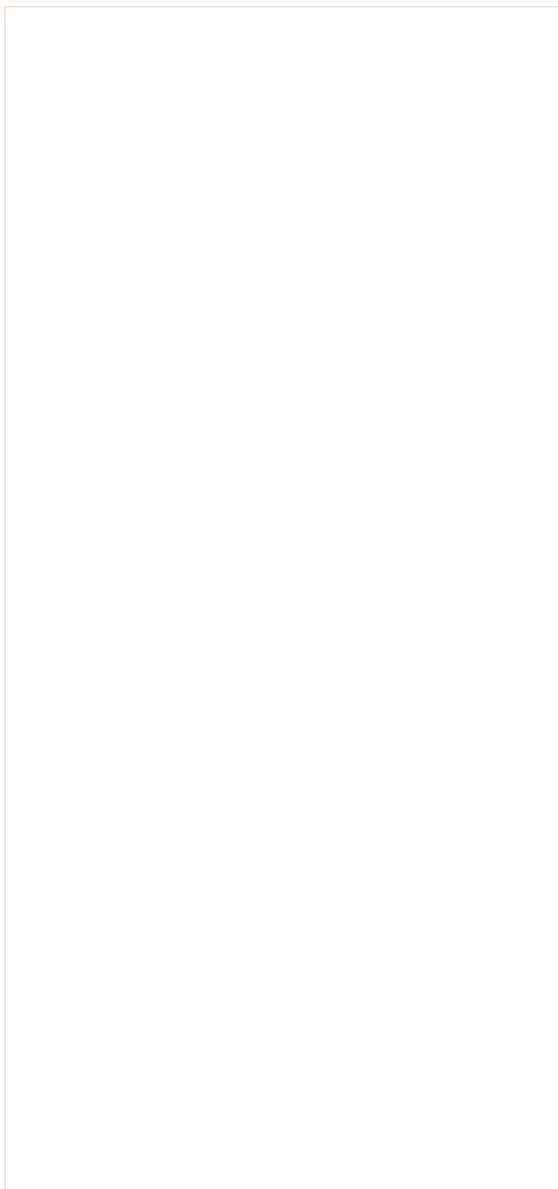
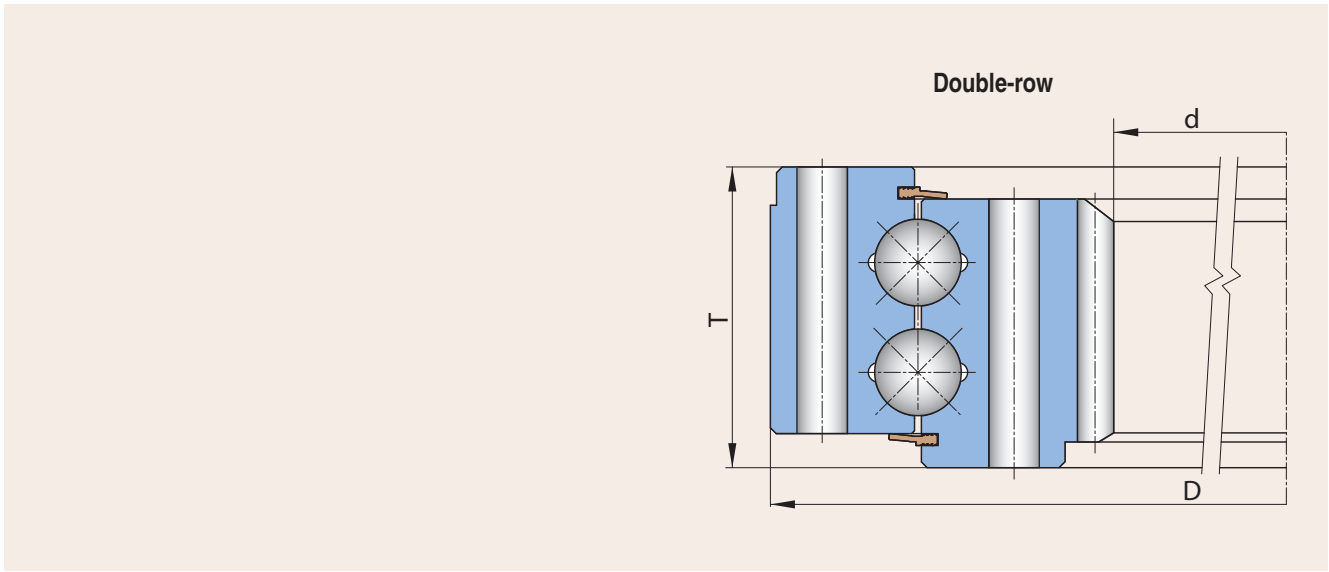

**Double-row**

Boundary Dimensions			Designation	Weight
d	D	T		G
				[kg]
1189	1540	130	9I-2B35-1385-1278	590
1470	1871	122	9I-2B32-1700-0995	785
1625.1	1905.7	137.9	9E-2B30-1735-0988	582
1630	2112	153	9E-2B32-1810-1348	1240
1657.3	2080	142	9I-2B35-1900-1232	1075
1686	2044	165.86	9E-2B40-1835-0776	945
1784.5	2500	135	9I-2B50-2312-1313 - 3kr*	1914
2147	2580	182	9I-2B45-2400-1327	1705
3006	3450	156	9I-2B40-3300-1069	2121

Note:  
 \* Double-row three-ring slewing bearing

## CROSSED ROLLER SLEWING RINGS – without gear

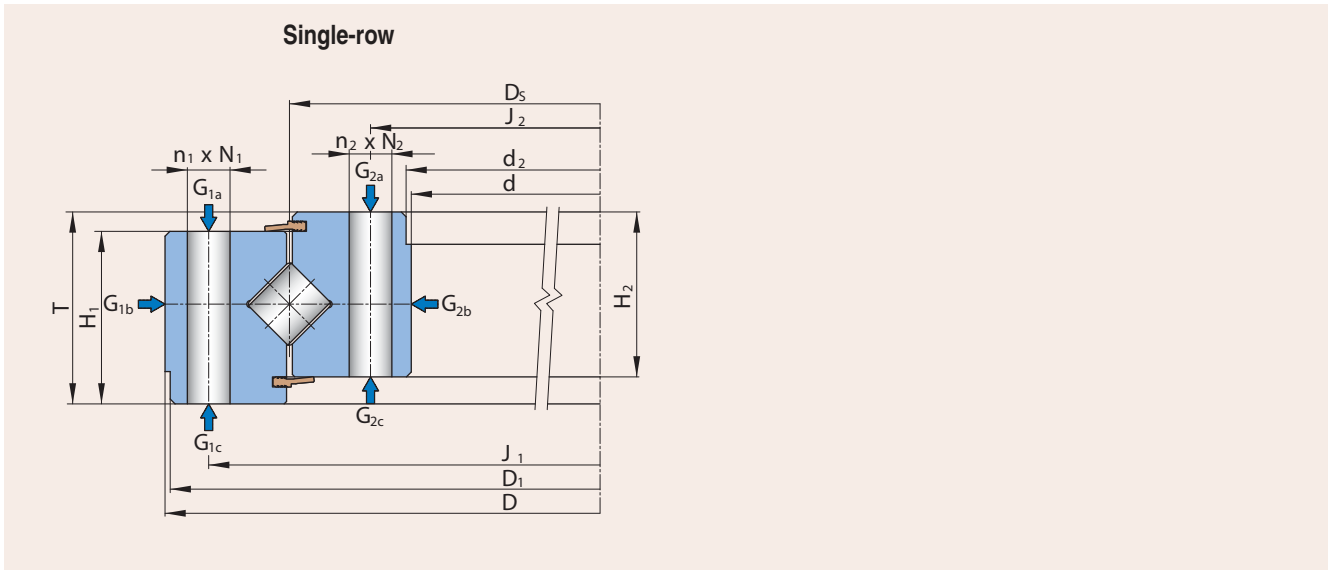

### Single-row

Boundary Dimensions			Designation	Weight	Abutment Dimensions				Mounting Holes $N_1$		Mounting Holes $N_2$	
d	D	T			G	$J_1$	$J_2$	$N_1$	$N_2$	Number $n_1$	Hole Type	Number $n_2$
[mm]			[kg]	[mm]								
108	210	26	90-1Z08-0168-0864	4.5	192.5	133	M8	9	12	C	12	B
124.5	234	35	90-1Z12-0179-0858	7	214	144.5	11	11	12	A	12	A
130	205	25.4	90-1Z08-0168-1178	4.5	190	145	6.8	6.8	12	B	12	B
130	310	65	90-1Z20-0220-0184	24.5	278	162	17	17	10	A	10	A
136	250	40	90-1Z14-0193-0152	8.2	230	156	11	11	12	A	12	A
136	250	40	90-1Z14-0193-0152-1	8.2	230	156	M10	M10	12	C	12	C
136	250	40	90-1Z14-0193-0152-2	8.5	229.5	156	9	M8	12	B	12	C
140	300	36	90-1Z12-0222-0440-4	12	270	170	18	18	6	A	6	A
140	300	39	90-1Z14-0222-1026-1	12.5	270	170	M16	M16	12	C	12	C
141	299	36	90-1Z12-0222-0619	11	270	170	M16	18	12	C	12	A
180	332	42	90-1Z14-0254-0168-1	14	300	210	13	13	24	A	(24-1)	A
200	304	30	90-1Z10-0250-0176-2	7.5	288	216	11	M10	9	A	9	C
200	304	30	90-1Z10-0250-0176-3	7.5	288	216	M10	M10	9	C	9	C
205.5	335	30	90-1Z12-0275-1180	12	315	231	11	M10	8	B	8	C
220	370	64	90-1Z20-0295-0151	26	345	245	11	11	12	A	12	A
220	370	64	90-1Z20-0295-0595	25	345	245	M12	13	16	D	(20-1)	A
230	400	68	90-1Z25-0315-0487	32	375	255	15	15	(24-1)	A	24	A
230	400	68	90-1Z25-0315-0487-1	32	375	255	M14	15	(24-1)	D	24	A
240	360	36	90-1Z14-0300-0378	12.5	360	260	8.4	8.4	12	A	12	A
250	340	29	90-1Z10-0295-0972	7.5	325	265	9	9	8	A	8	A
250	366	40	90-1Z14-0305-0218	14	345	270	11	11	20	B	20	A
295	455	85	90-1Z25-0384-0544	47	425	323	M20	M16	16	D	16	E
300	500	80	90-1Z30-0400-0488	60	470	330	17	17	(24-1)	A	24	A
300	500	80	90-1Z30-0400-0488-1	60	470	330	M16	17	(24-1)	C	24	A
340	550	90	90-1Z30-0461-0260	83	515	380	M20	22	20	D	(22-1)	A
340	580	86	90-1Z30-0461-0125	90	540	380	22	M20	20	A	(22-1)	E
340	580	86	90-1Z30-0461-0278	90	540	380	22	22	20	A	(22-1)	A
435	698.5	85	90-1Z30-0561-0432-1	127	644.5	473	20.5	24	18	B	24	A
465	725	100	90-1Z40-0595-0480	146	685	505	22	22	(30-1)	A	30	A
640	868	97	90-1Z30-0766-38	163	838	684	M20	M20	30	D	30	E
705	935	90	90-1Z30-0820-1351	161.5	895	745	22	22	30	A	30	A
715	935	100	90-1Z30-0823-15-1	166	893	753	22	22	18	A	18	A
726	940	75	90-1Z25-0839-0799	126	906	756	18	18	32	A	32	A
868	1095	100	90-1Z30-0980-16-8	210	1050	910	17	17	18	A	18	A
870	1090	79	90-1Z25-0980-0902	167	1050	910	22	22	44	A	44	A

### Mounting holes types

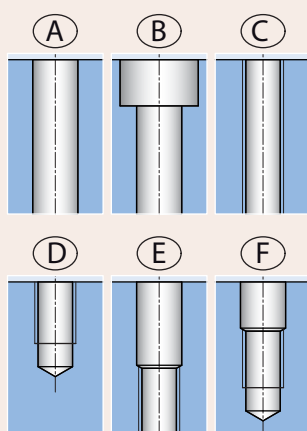

### Lubrication spots types

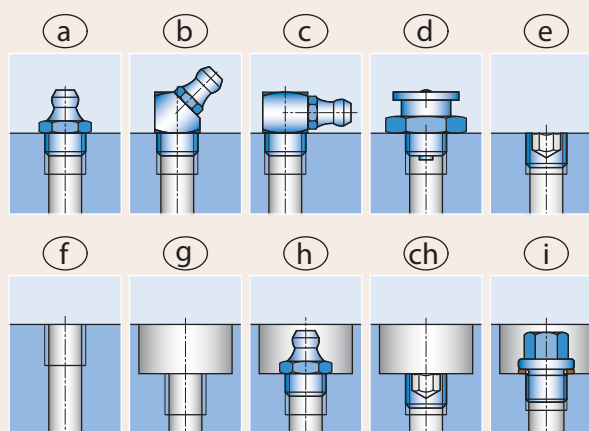

Other Specifications				Lubrication Spots				Note No.	Notes
D <sub>1</sub>	d <sub>2</sub>	H <sub>1</sub>	H <sub>2</sub>	Type	Size	Location	Number		
[mm]									
210	108	24.8	24.8	a	AM8x1	G1b	4		1 – Lubricant filling for the total lifetime
232	126.5	30	30	h	AM8x1	G1b	1		2 – The outer ring piloted on the inner diameter
205	130	24.8	24.8	–	–	–	–	1	3 – Lubricating holes on the pitch circle dia. 2320 mm
310	130	57	57	f	M10x1	G1b	2		
–	–	35	35	f	M8x1	G1a	2		
–	–	35	35	f	M8x1	G1a	2		
–	–	35	35	f	M8x1	G1a	2		
298	142	30	30	f	M10x1	G1b	1		
300	140	33	33	a	AM8x1	G1b	4		
299	141	30	30	a	AM8x1	G1b	2		
332	180	35	35	f	M10x1	G1b	1		
–	200	27	24	–	–	–	–	1	
–	200	27	24	h	AM8x1	G1b	2		
–	–	30	30	e	1/8-27 NPT	G2a	1		
370	220	55	55	f	M10x1	G1b	2		
370	220	55	55	f	M10x1	G1b	4		
400	230	58	58	f	M10x1	G1b	2		
400	230	58	58	f	M10x1	G1b	4		
358	242	31	31	f	M8x1	G2c	1		
–	250	24	24	–	–	–	–	1	
365	250	35	35	f	M8x1	G1b	2		
455	295	75	70	f	M10x1	G2b	2		
500	300	70	70	f	M10x1	G1b	2		
500	300	70	70	f	M10x1	G1b	2		
470	340	80	72	f	M10x1	G1b	4	2	
580	340	76	76	f	M10x1	G2a	2		
580	340	76	76	f	M10x1	G1b	2		
–	435	76	76	f	1/8-27 NPT	G1b/G2b	6/6		
725	465	90	90	f	M10x1	G1b	3		
868	640	82	87	f	M10x1	G1b	2		
935	705	80	80	a	AM10x1	G1b	3		
845	718	83	84	f	M8x1	G1a	4	2	
–	726	65	65	a	M10x1	G1b	4		
993	870	83	86	f	M10x1	G1b	3	2	
1090	870	72	72	a	M10x1	G1b	4		



### CROSSED ROLLER SLEWING RINGS – without gear

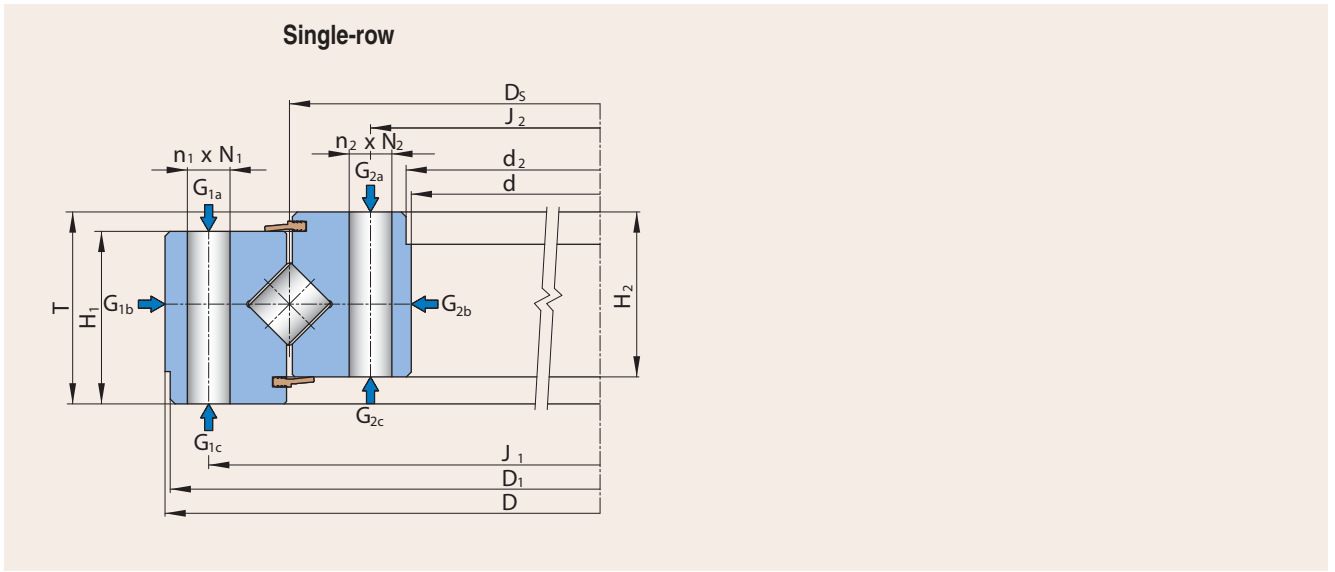

### Single-row

Boundary Dimensions			Designation	Weight	Abutment Dimensions				Mounting Holes N <sub>1</sub>		Mounting Holes N <sub>2</sub>	
d	D	T		G	J <sub>1</sub>	J <sub>2</sub>	N <sub>1</sub>	N <sub>2</sub>	Number n <sub>1</sub>	Hole Type	Number n <sub>2</sub>	Hole Type
[mm]				[kg]	[mm]							
1891	2245	140	90-1Z50-2071-0315	960	2190	1950	32	32	45	A	45	A
1945	2136	67	90-1Z20-2045-0757	253	2100	1985	14	18	36	A	36	A
2095	2420	135	90-1Z40-2248-55	1020	2365	2140	33	26	32	A	48	A
2095	2420	135	90-1Z40-2248-55-1	1020	2365	2140	33	26	32	A	48	A



## CROSSED ROLLER SLEWING RINGS – without gear – special

Single-row

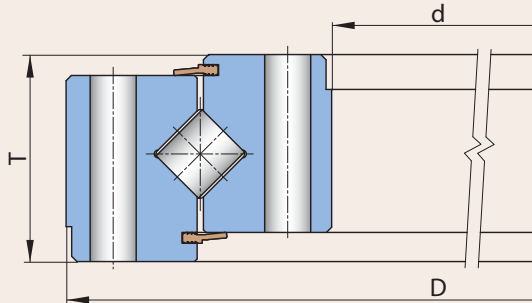

Single-row

Boundary Dimensions			Designation	Weight
d	D	T		G
[mm]				[kg]
60	240	37	90-1Z10-0147-0376	10.5
100	330	65	90-1Z20-0262-0978	27.5
100	395	65	90-1Z20-0308-0912	39
108	210	26	90-1Z08-0168-0864-1	4.5
120	260	58	90-1Z16-0195-1385	14.5
120	260	58	90-1Z16-0195-1406	14.5
124	234	35	90-1Z12-0179-0918	7
130	250	40	90-1Z14-0193-0514	8.2
130	250	40	90-1Z14-0193-0514-1	8
130	250	40	90-1Z14-0193-0514-3	8.2
130	310	65	90-1Z20-0220-0184-1	24.5
140	300	36	90-1Z12-0220-0532	12
140	300	36	90-1Z12-0220-0532-1	12
140	300	36	90-1Z12-0222-0440-1	12
140	300	36	90-1Z12-0222-0440-2	12
140	300	36	90-1Z12-0222-0440-3	12
140	300	36	90-1Z12-0222-0440-5	12
140	300	36	90-1Z12-0215-0693	12
140	300	36	90-1Z12-0215-0693-1	12
141	299	36	90-1Z12-0222-1233	11
160	266	30	90-1Z10-0216-0177	6.3
160	290	40	90-1Z16-0225-0634	13
170	290	28	90-1Z10-0225-0247	6
180	332	42	90-1Z14-0254-0168	14
200	295	30	90-1Z10-0225-0456	5.3
200	304	30	90-1Z10-0250-0176	7.6
200	304	30	90-1Z10-0250-0176-1	7.6
200	304	30	90-1Z10-0250-0176-4	7.5
200	304	30	90-1Z10-0250-0176-5	7.5
200	304	30	90-1Z10-0250-0176-6	7.5
212	352	40	90-2Z20-0282-0291	17.5
214	356.5	56	90-1Z16-0283-0590	24.5
234	403.5	55	90-1Z20-0308-0298	28
234	403.5	55	90-1Z20-0308-0298-1	28
235	379	55	90-1Z16-0310-0976	24.5

Single-row

Boundary Dimensions			Designation	Weight
d	D	T		G
[mm]				[kg]
240	320	35	90-1Z14-0280-0138	8.6
250	310	25	90-1Z10-0280-0423	5
250	340	29	90-1Z10-0295-0972-1	7.5
250	360	40	90-1Z14-0305-0173	13
250	365	37	90-1Z14-0305-0115	14.4
250	430	64	90-1Z20-0344-1075	36
255	390	42	90-1Z18-0300-1097	18.5
280	389	55	90-1Z22-0337-0416	23
280	560	75	90-1Z20-0461-0606	66
300	455	85	90-1Z25-0384-0246	43
300	460	60	90-1Z14-0384-86	34.3
300	460	85	90-1Z25-0384-18	45
300	460	85	90-1Z25-0384-0102	45
300	460	85	90-1Z25-0384-0403 S	47
300	500	60	90-1Z14-0384-86-1	39.4
330	400	35	90-1Z18-0368-0811	12.5
335	475	45	90-1Z14-0405-0137	24
335	475	45	90-1Z14-0405-0155	27
340	550	90	90-1Z30-0461-28	75
340	550	90	90-1Z30-0461-28-1	75
340	550	90	90-1Z30-0461-28-2	75
340	550	90	90-1Z30-0461-0821 S	77.5
340	580	86	90-1Z30-0461-0806	89
344	484	56	90-1Z14-0414-0575	28
345	478	42	90-1Z14-0405-0147	18
345	478	42	90-1Z14-0405-0148	18
360	440	40	90-1Z20-0400-0777	14
390	480	45	90-1Z25-0435-0722	20
430	642	56	90-1Z20-0548-0927	61
435	698.5	85	90-1Z30-0561-0432	127
448.5	645	91.5	90-1Z45-0550-1363	95
460	600	45	90-1Z14-0530-0154	36.2
470	626	50	90-1Z16-0548-0338	39
570	786	91.5	90-1Z30-0678-1037	120
596.9	787.4	76.2	90-1Z40-0708-0820	114

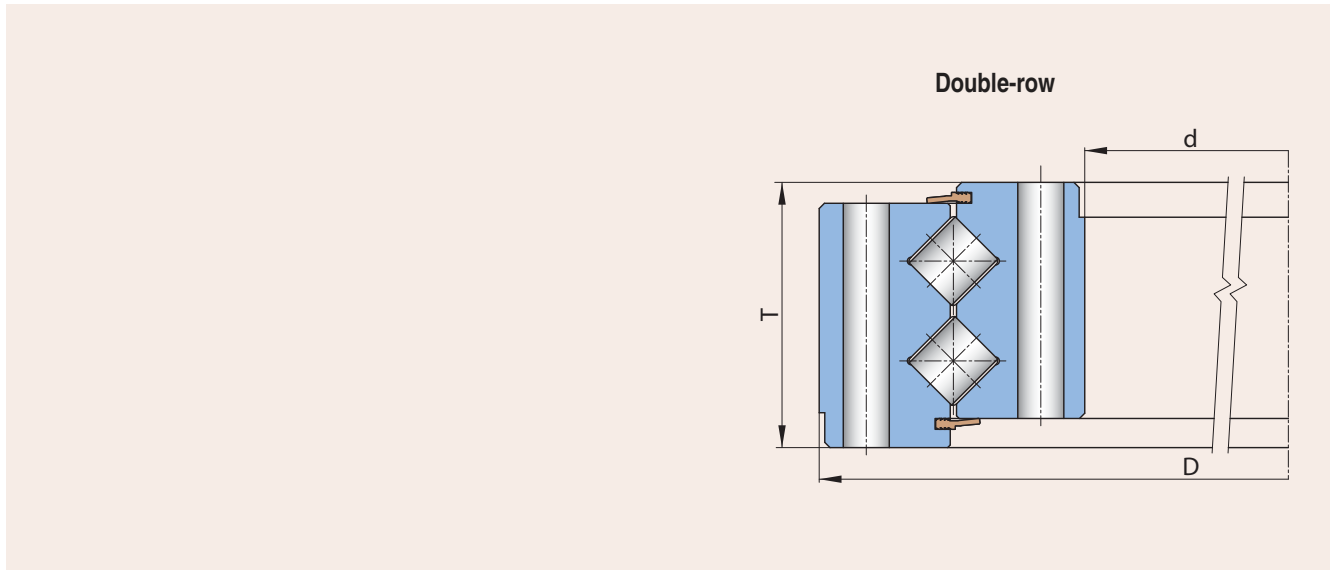

**Single-row**

Boundary Dimensions			Designation	Weight
d	D	T		
[mm]				[kg]
640	868	97	90-1Z30-0766-38-1	169
715	935	100	90-1Z30-0823-0131	179
717	979	100	90-1Z30-0823-0242	201
720	1000	130	90-1Z40-0860-0441	286
734	844	40	90-1Z10-0787-0262	38
742	832	40	90-1Z10-0787-0199	34
760	950	56	90-1Z14-0839-0123	53.3
868	1095	100	90-1Z30-0980-16-3	208
870	1095	85	90-1Z30-0980-0872	195
1000	1200	56	90-1Z14-1089-0113	84.8
1405	1810	150	90-1Z40-1621-0425	890
1554	2020	114	90-1Z36-1800-1134	1118
1610	2025	130	90-1Z40-1815-0106	998
1623	1879.6	128	90-1Z36-1753-0412	544
1644	1866	75	90-1Z25-1747-0142	278
1891	2245	140	90-1Z50-2071-0315-1	960

**Double-row**

Boundary Dimensions			Designation	Weight
d	D	T		
[mm]				[kg]
340	460	125	90-2Z25-0400-0143	61.5

## CROSSED ROLLER SLEWING RINGS – with external gear

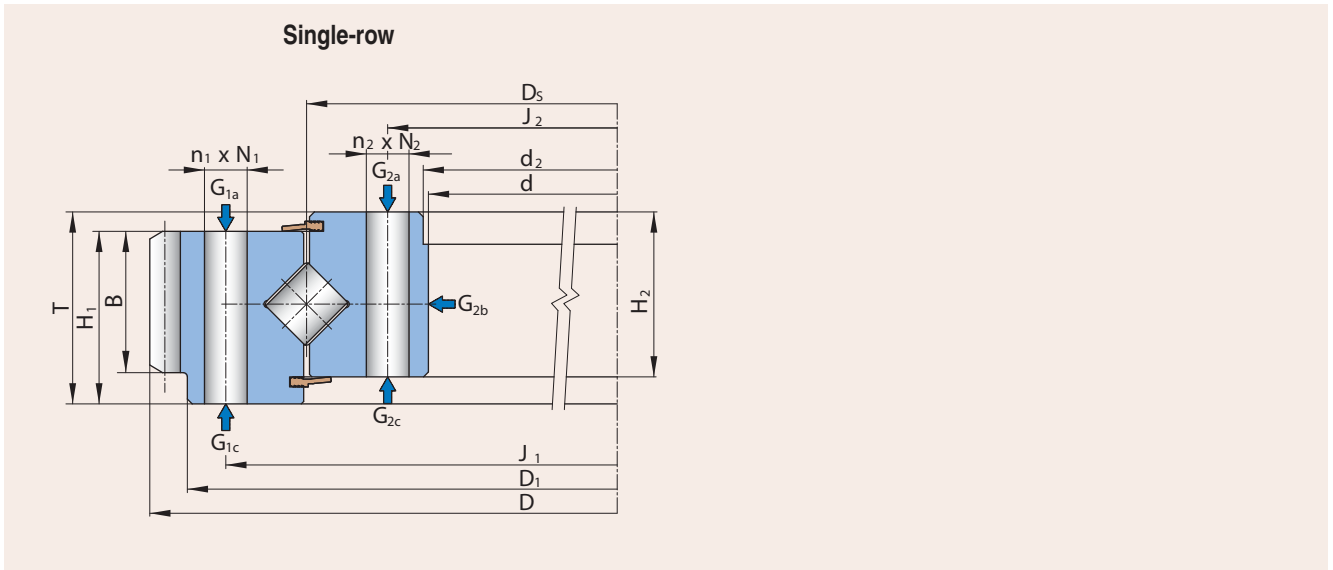

### Single-row

Boundary Dimensions			Designation	Weight	Abutment Dimensions				Mounting Holes $N_1$		Mounting Holes $N_2$	
d	D	T			G	$J_1$	$J_2$	$N_1$	$N_2$	Number $n_1$	Hole Type	Number $n_2$
[mm]			[kg]	[mm]								
140	300	36	9E-1Z12-0215-0694	11	258	170	M16	18	12	C	12	A
180	342	42	9E-1Z14-0254-0110	14.5	300	210	13	M12	24	A	(24-3)	C
180	342	42	9E-1Z14-0254-0862	14.5	300	210	13	M12	24	A	(24-3)	C
234	403.5	55	9E-1Z20-0309-0765	23	358	259	13	13	24	A	(28-1)	A
234	403.5	55	9E-1Z16-0310-0111-3	27	358	259	M12	M12	24	C	20	C
235	403.5	55	9E-1Z16-0310-0517	24	358	259	13	13	24	A	(28-1)	A
300	460	85	9E-1Z25-0384-18-1	45	430	323	M16	13	16	D	(20-1)	A
340	579.8	90	9E-1Z30-0461-0119	86	515	380	M20	22	20	D	(22-1)	A
340	579.8	90	9E-1Z30-0461-0126	86	515	380	M20	M20	20	D	(22-1)	D
344	503.3	56	9E-1Z14-0414-0635	27	455	368	M12	14	20	D	24	A
380	589.5	75	9E-1Z20-0474-0100	67	540	410	M16	17	18	D	18	A
390	664	85	9E-1Z30-0505-0597	102	578	432	22	M20	30	A	(30-1)	E
390	654	85	9E-1Z30-0508-0236	98	582	432	22	22	30	A	(30-1)	A
468	695	78	9E-1Z25-0576-1322	88.5	640	508	18	18	36	A	(36-1)	A
470	708	83	9E-1Z25-0575-1044	93	640	508	17	17	36	A	(36-1)	A
573	816	90	9E-1Z25-0675-0145	120	753	604	22	22	18	A	18	A
573	838	90	9E-1Z25-0675-1045	132	753	604	22	22	36	A	(36-1)	A
634	846	75	9E-1Z20-0730-1198	102	795	667	M16	M16	18	D	18	D
634	846	75	9E-1Z20-0730-0101	102	795	667	M16	17	18	D	18	A
715	979	100	9E-1Z30-0823-15	180	893	753	22	22	18	A	18	A
715	979	100	9E-1Z30-0823-15-2	183	893	753	22	22	18	A	18	A
715	979	100	9E-1Z30-0823-37	177	893	753	22	22	18	A	18	A
715	979	100	9E-1Z30-0823-80	172	893	753	22	22	36	A	(36-1)	A
715	979	100	9E-1Z30-0823-1250	176	893	753	22	M20	36	A	36	E
868	1144	100	9E-1Z30-0980-16	230	1050	910	22	22	18	A	18	A
890	1080	82	9E-1Z25-0984-0452	125	1010	922	M16	M16	30	D	36	E
890	1089	90	9E-1Z25-0980-0294	141	1015	922	M16	18	30	D	30	A
985	1270	115	9E-1Z30-1110-0710	301	1185	1034	22	22	36	A	36	A
1084	1476	110	9E-1Z40-1250-0263	475	1350	1150	26	26	24	A	28	A
1206	1604	130	9E-1Z45-1390-0841	635	1500	1280	30	30	48	A	(48-1)	A
1330	1591.7	115	9E-1Z25-1468-1251	377	1512	1400	M20	M20	40	D	40	E
1362	1590	111	9E-1Z30-1473-78	284	1510	1398	M22	M22	40	D	40	E
1430	1808	141	9E-1Z40-1584-26	772	1671	1485	M27	33	30	D	30	A
1430	1808	141	9E-1Z40-1584-26-3	772	1671	1485	M27	33	30	D	30	A
1530	1967.9	130	9E-1Z50-1722-1238	920	1850	1590	32	32	48	A	48	A



### Mounting holes types

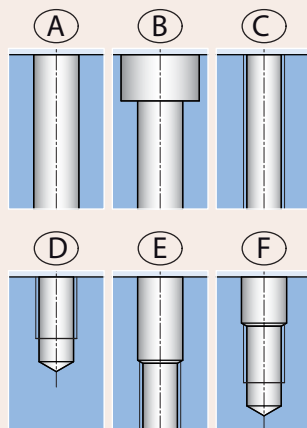

### Lubrication spots types

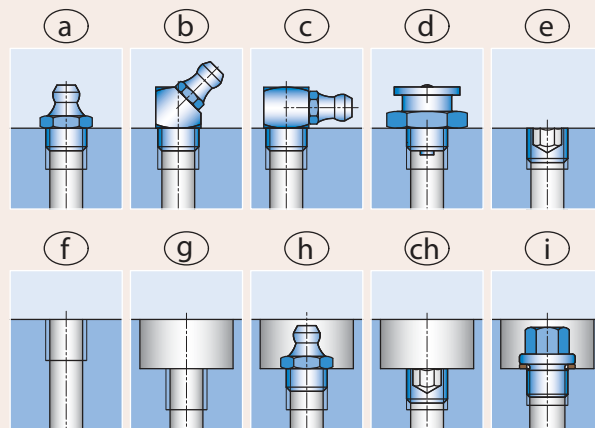

Other Specifications								Permissible Circumferential Force		Lubrication Spots				Note No.	Notes
D <sub>1</sub>	d <sub>2</sub>	H <sub>1</sub>	H <sub>2</sub>	B	m (DP)	z	x	F <sub>TDoV</sub>	F <sub>Tmax</sub>	Type	Size	Location	Number		
[mm]								[kN]							
-	-	30	30	30	4	73	0	9	18	a	AM10x1	G2b	1		1 - The outer ring piloted on the inner diameter
258.5	180	35	35	30	3	112	0	6	12	f	M10x1	G2a	2	1	
258.5	180	35	35	30	3	112	0	8	16	f	M10x1	G2a	2	1	
312	235	47	47	39	4.5	88	0	13	26	f	M10x1	G2b	2	1	
312	235	47	47	39	4.5	88	0	16	32	f	M10x1	G2a	2	1	
312	235	46	45	40	4.5	88	0	14	28	g	M10x1	G1a	2	1	
450	300	75	70	60	5	93	0	22	44	f	M10x1	G2a	2		
470	340	80	72	62	5	114	0	16	32	f	M10x1	G2a	2	1	
470	340	80	72	62	5	114	0	16	32	f	M10x1	G2a	2	1	
-	344	44.5	44.5	44.5	5	99	0	10	20	a	AM8x1	G2b	4		
565	384	60	58	40	4.5	129	0	9	18	f	M8x1	G2a	2		
515	392	72	73	71	10	64	+0.25	63	126	f	M10x1	G2b	3	1	
610	392	73	73	60	8	80	0	44	88	f	M10x1	G2b	3		
-	470	68	69	42	5	137	0	16.5	33	a	AM10x1	G2b	3		
578	471	70	70	70	10	69	0	63	126	a	AM10x1	G2b	3	1	
682	574	73	70	65	6	132	+1.092	29	58	a	M10x1	G1a/G2b	4/3	1	
682	574	73	70	73	10	81	+0.5	85	170	a	AM10x1	G2b	2	1	
822	640	60	58	55	4.5	186	0	20	40	f	M8x1	G2a	2		
822	640	60	58	40	4.5	186	0	14	28	f	M8	G2a	2		
845	718	83	84	63	10	94	+1.1	73	146	f	M8x1	G1a	4	1	
845	718	83	84	70	10	94	+1.1	53	106	f	M10x1	G1a	4	1	
825	-	83	84	83	8	120	0	34	68	f	M8x1	G1a	4	1	
845	718	83	84	63	10	94	+1.1	69	138	f	M10x1	G1a	4	1	
933	718	83	84	67	10	94	+1.1	77	154	ch	M10x1	G1a/G2b	4/4		
993	870	83	86	66	10	111	+0.7	76	152	f	M10x1	G1a	4	1	
-	895	70	67	62	8	133	0	45	90	f	M10x1	G2b	4		
983	890	75	67	75	9	119	0	65	130	f	M10x1	G2b	3	1	
1140	988	86	106	80	10	125	0	67	134	f	M10x1	G1a/G2b	6/6	1	
1415	1085	91	100	77	10	144	+0.86	89	178	f	M10x1	G2b	4		
1394	1208	112	116	85	10	157	+0.75	86	172	f	M10x1	G2b	4	1	
1464	1330	103	88	91	9	175	0	78	156	f	Rp 1/4	G2b	8	1	
-	1362	95	84	60	10	157	0	57	114	f	M8x1	G2b	4		
1608	1437	125	118	125	16	111	0	104	208	f	M10x1	G1a/G2b	4/2	1	
1608	1437	125	118	125	16	111	0	125	250	f	M10x1	G1a/G2b	4/2	1	
-	-	120	120	110	12	162	0	126	252	g	M10x1	G1a	4		



### CROSSED ROLLER SLEWING RINGS – with external gear

Single-row

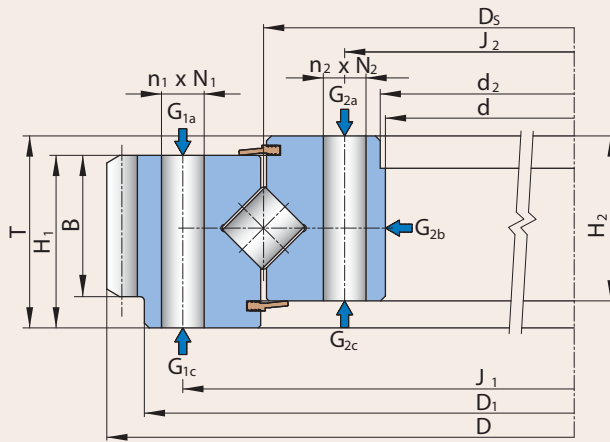

Single-row

Boundary Dimensions			Designation	Weight G	Abutment Dimensions				Mounting Holes N <sub>1</sub>		Mounting Holes N <sub>2</sub>	
d	D	T			J <sub>1</sub>	J <sub>2</sub>	N <sub>1</sub>	N <sub>2</sub>	Number n <sub>1</sub>	Hole Type	Number n <sub>2</sub>	Hole Type
[mm]					[mm]							
1615	2027	150	9E-1Z50-1790-0232	970	1905	1675	30	30	36	A	36	A
1615	2027	150.1	9E-1Z45-1791-0706	1009	1905	1675	30	30	36	A	36	A
1680	2028	120	9E-1Z30-1830-0297	630	1915	1745	30	30	48	A	48	A
1720	2074	123	9E-1Z36-1870-1291	752	1960	1780	M27	30	36	E	36	A

### Mounting holes types

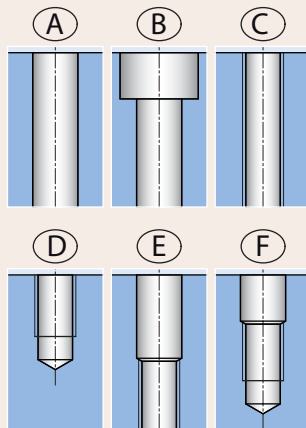

### Lubrication spots types

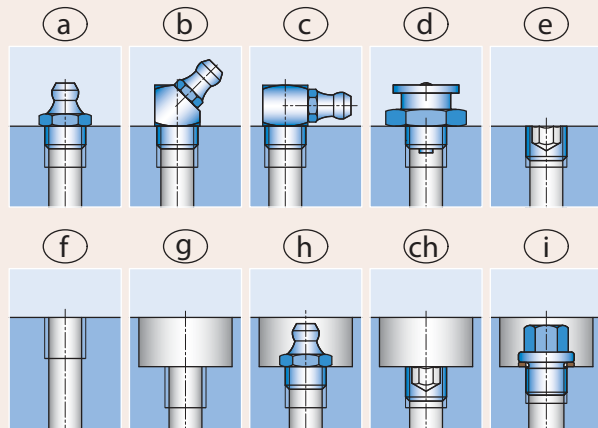

Other Specifications								Permissible Circumferential Force		Lubrication Spots				Note No.	Notes
D <sub>1</sub>	d <sub>2</sub>	H <sub>1</sub>	H <sub>2</sub>	B	m (DP)	z	x	F <sub>TDoV</sub>	F <sub>Tmax</sub>	Type	Size	Location	Number		
[mm]								[kN]							
1617	1808	130	128	120	14	142	+0.5	185	370	f	M10x1	G1a/G2b	6/6	1	1 - The outer ring piloted on the inner diameter
1617	1808	130	128	120	14	142	+0.5	162	324	f	1/8-27 NPT	G1a	4	1	
-	-	90	100	90	10	200	+0.4	68	136	f	M10x1	G2b	6		
2020	1720	110	110	100	12	170	+0.5	139	278	a	AM10x1	G2b	12		

## CROSSED ROLLER SLEWING RINGS – with external gear – special

Single-row

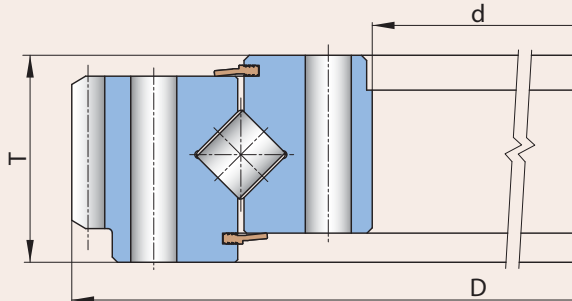

Single-row

Boundary Dimensions			Designation	Weight
d	D	T		G
[mm]				[kg]
101.6	219.1	31.8	9E-1Z10-0152-0524	5.3
101.6	217.1	31.8	9E-1Z10-0152-0307	18
140	300	36	9E-1Z12-0215-0694-1	11
140	348	39	9E-1Z14-0222-0439	18
180	340	42	9E-1Z14-0254-1333	14
180	342	42	9E-1Z14-0254-0110-1	15.5
190	323.4	34	9E-1Z10-0250-0673	11
234	403.5	55	9E-1Z20-0309-0682	23
234	403.5	55	9E-1Z20-0309-0822	23
234	403.5	55	9E-1Z16-0310-1336	26
235	405	55	9E-1Z16-0310-0111	23
235	405	55	9E-1Z16-0310-0111-1	23
235	405.3	60	9E-1Z20-0309-0628	30
274	462	59	9E-1Z20-0354-0600	36
295	531.3	90	9E-1Z25-0384-0631	57
408	586.4	75	9E-1Z20-0498-0227	60
518	848	120	9E-1Z30-0668-0331	232
518	848	120	9E-1Z30-0668-0331-1	232
571	817	101	9E-1Z30-0680-1174	63.5
573	816	90	9E-1Z25-0675-0145-1	120
634	846	60	9E-1Z20-0730-0913	102.5
635	849.7	65	9E-1Z20-0730-0830	95
640	900	97	9E-1Z30-0766-0122	181
640	900	97	9E-1Z30-0766-0122-1	181
640	909	90	9E-1Z30-0766-0214	640
690	938	76	9E-1Z20-0842-0630	112
715	979	100	9E-1Z30-0823-15-3	180
715	979	100	9E-1Z30-0823-0166	198
718	979	100	9E-1Z30-0823-0277	185
718	979	100	9E-1Z30-0823-1124	177
736	944	56	9E-1Z16-0844-0871	84
868	1143	100	9E-1Z30-0980-1042	243
868	1144	100	9E-1Z30-0980-16-1	230
868	1144	99.2	9E-1Z30-0980-16-1 P4	230
868	1144	100	9E-1Z30-0980-16-4	225

Single-row

Boundary Dimensions			Designation	Weight
d	D	T		G
[mm]				[kg]
868	1144	99.2	9E-1Z30-0980-16-4 P4	224
868	1144	100	9E-1Z30-0980-16-7	229
868	1144	100	9E-1Z30-0980-0224	220
868	1144	100	9E-1Z30-0980-0276	245
868	1144	100	9E-1Z30-0980-1359	245
869	1144	100	9E-1Z30-0980-0458	218
880	1104	90	9E-1Z30-0980-0104	200
880	1220	120	9E-1Z30-1035-21	361
880	1220	120	9E-1Z30-1035-21-1	360
880	1220	120	9E-1Z30-1035-21-2	361
904.9	1198.9	90.4	9E-1Z30-1029-0645	284
970	1344	120	9E-1Z40-1125-47	467
984	1289.5	114	9E-1Z36-1116-0237	326
984	1289.5	114	9E-1Z36-1116-1206	326
1000.8	1280.2	89	9E-1Z30-1121-1022	268
1000.8	1286.7	127	9E-1Z40-1121-0460	411
1014	1290.3	130	9E-1Z40-1124-0436	385
1084	1450	109	9E-1Z40-1250-1340	492
1084	1476	110	9E-1Z40-1250-0828	475
1203.5	1604	128	9E-1Z50-1390-1258	624
1206	1604	130	9E-1Z50-1390-0231	635
1210	1757.3	130	9E-1Z40-1448-0559	1057
1270	1620	135	9E-1Z30-1420-22-1	692
1270	1620	135	9E-1Z30-1420-22	692
1270	1620	135	9E-1Z30-1420-1201	692
1362	1590	111	9E-1Z30-1473-78-1	285
1362	1590	111	9E-1Z30-1473-78-2	284
1430	1808	141	9E-1Z40-1584-0118	770
1430	1800	141	9E-1Z40-1584-26-1	768
1430	1808	141	9E-1Z40-1584-0371	772
1460	1722	97	9E-1Z30-1584-0658	373
1596	2167.3	140	9E-1Z40-1869-1216	1665
1686	2034	102	9E-1Z40-1848-0328	700
1690	1980	92	9E-1Z30-1858-0730	515
1860	2080	92	9E-1Z30-1973-0729	355

**Double-row**

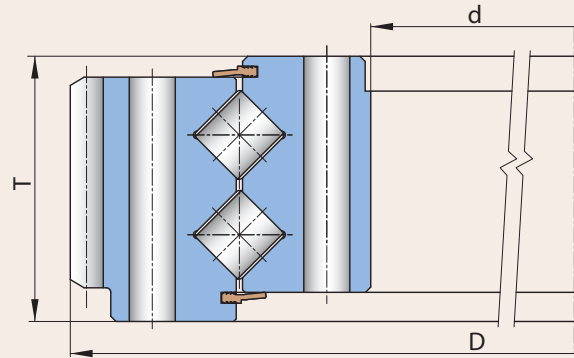

**Single-row**

Boundary Dimensions			Designation	Weight
d	D	T		
				G
[mm]				[kg]
2320	2613.6	109	9E-1Z36-2435-0349	710
2320	2613.6	109	9E-1Z30-2435-0349-1	702

**Double-row**

Boundary Dimensions			Designation	Weight
d	D	T		
				G
[mm]				[kg]
571	878.4	187.5	9E-2Z25-0677-0880	330



## CROSSED ROLLER SLEWING RINGS – with internal gear

Single-row

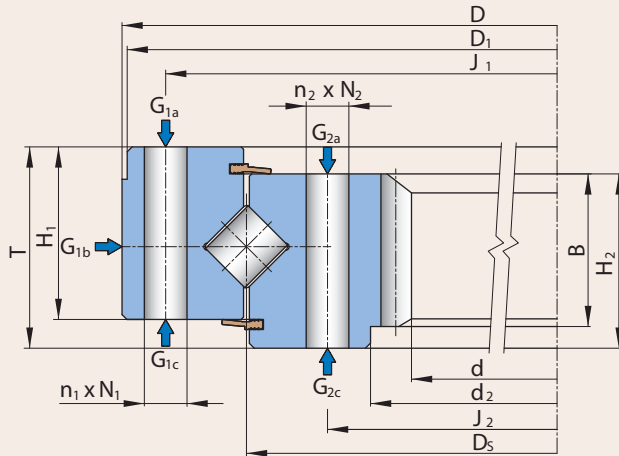

Single-row

Boundary Dimensions			Designation	Weight	Abutment Dimensions				Mounting Holes $N_1$		Mounting Holes $N_2$	
d	D	T			G	$J_1$	$J_2$	$N_1$	$N_2$	Number $n_1$	Hole Type	Number $n_2$
[mm]			[kg]	[mm]								
216	340	38	9I-1Z12-0288-0991	12	324	252	9	9	20	A	20	A
325.5	486	56	9I-1Z16-0415-0196	32	460	375	M12	13	24	D	24	A
325.5	486	56	9I-1Z16-0415-0196-1	32	460	375	13	13	24	A	24	A
332.8	486	56	9I-1Z16-0415-0510	31	460	375	M12	13	24	D	24	A
385	562	60	9I-1Z18-0489-1337	45	538	440	13	13	30	A	30	A
504	722	54	9I-1Z18-0635-1402	67	690	580	18	18	24	A	24	A
644	820	54	9I-1Z20-0742-1335	62	792	692	M12	M12	20	D	20	D
744	988	73	9I-1Z25-0886-0538	144	952	820	18	M16	30	A	30	D
770.1	1054.1	106.5	9I-1Z30-0923-0534	247	1016	850.9	20.5	3/4 16-UNF	36	A	36	D
824	1170	120	9I-1Z30-1035-0174	363	1120	940	26	M30	24	A	16	D
940	1200	100	9I-1Z30-1090-1151	247	1160	1040	18	M20	36	A	36	D
941	1190	110	9I-1Z30-1090-0756	236	1160	1040	18	M20	36	A	36	D
954	1175	90	9I-1Z25-1075-0654	170	1134	1040	18	M16	36	A	36	D
961	1300	105	9I-1Z40-1150-1123	374	1250	1055	26	M24	36	A	36	D
963	1365	170	9I-1Z40-1175-30	692	1315	1080	27	M24	30	A	30	D
1130.5	1427	95	9I-1Z30-1305-0406	346	1390	1220	21	21	36	A	36	B
1165.5	1530	130	9I-1Z40-1385-0715	560	1480	1290	26	M24	36	A	36	E
1177	1530	130	9I-1Z40-1385-0301	555	1480	1290	26	M24	36	A	36	E
1178	1530	130	9I-1Z40-1385-0639	541	1480	1290	26	M24	48	A	48	E
1224	1512	90	9I-1Z30-1380-1053	315	1468	1332	27	M24	24	A	24	D
1414.9	1795	140	9I-1Z40-1632-0194	870	1740	1550	27	M24	36	A	36	D
2092	2650	190	9I-1Z60-2435-1221	2267	2580	2290	39	39	48	A	48	A
2126.3	2650	230	9I-1Z60-2435-1218	2363	2580	2290	40	40	48	A	48	A

### Mounting holes types

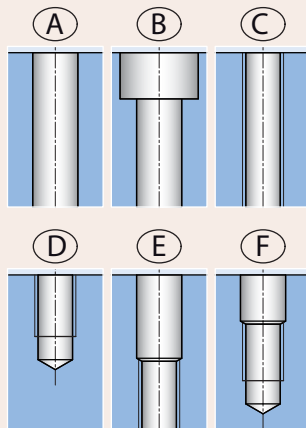

### Lubrication spots types

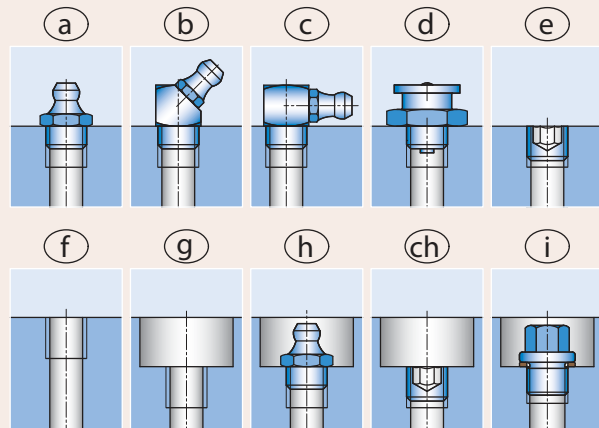

Other Specifications								Permissible Circumferential Force		Lubrication Spots			Note No.	Notes	
D <sub>1</sub>	d <sub>2</sub>	H <sub>1</sub>	H <sub>2</sub>	B	m (DP)	z	x	F <sub>TDoV</sub>	F <sub>Tmax</sub>	Type	Size	Location			Number
[mm]								[kN]							
338	285	33	34	34	4	56	0	12	24	h	AM6x1	G1b	2	1	1 – The outer ring piloted on the inner diameter
484	412	44	48	48	5	67	0	20	40	g	M8x1	G1b	2	1	2 – The inner ring piloted on the opposite face
484	412	44	48	48	5	67	0	20	40	g	M8x1	G1b	2	1	
484	412	44	48	48	4	85	0	16	32	g	M8x1	G1b	2	1	
560	418	50	50	45	6	66	0	25	50	h	AM10x1	G1b	2		
720	–	47	47	47	8	65	0	34.5	69	h	AM10x1	G1b	4		
820	665	45	45	35	4	162	-0.5	13.5	27	h	AM10x1	G1b	4		
–	–	64	64	64	8	94	-0.5	59	118	h	AM10x1	G1b	5		
–	–	85.6	88.9	88.9	DP2.5	77	-0.4	81	162	f	Rp 1/8	G1b	4		
1170	866	100	100	80	8	105	0	66	132	f	M10x1	G1b	2		
1190	–	80	90	80	10	94	-1	92	184	f	M10x1	G1b	4		
1190	1087	75	100	90	12	80	-0.167	122	244	f	M10x1	G1b	4	1	
1165	–	75	75	75	14	70	0	114	228	f	M10x1	G1b	3		
1300	1147	90	95	95	10	98	0	83	166	g	M10x1	G1b	4	1	
1355	1160	125	150	140	14	71	+0.1428	224	448	g	M10x1	G1b	3	1	
1425	–	80	85	85	10	115	0	87	174	f	M10x1	G1b	4		
–	1360	107	110	110	14	84	-0.5	173	346	g	M10x1	G1b	4	1	
–	1360	107	110	110	12	100	0	138	276	g	M10x1	G1b	4	1	
–	1360	107	107	100	12	100	0	125	250	g	M10x1	G1b	4	1	
1512	–	70	80	80	12	103	-0.5	93	186	f	M12x1.5	G1b	4		
1790	1600	120	130	115	14	103	0	160	320	g	M10x1	G1b	4	1	
–	2169	154	154	110	16	132	-0.3	178	356	f	M10x1	G1b	8	2	
–	2208	200	174	110	18	120	0	203	406	f	M10x1	G1b	8		

## CROSSED ROLLER SLEWING RINGS – with internal gear – special

Single-row

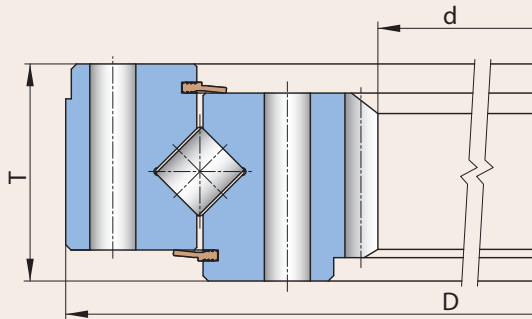

Single-row

Boundary Dimensions			Designation	Weight
d	D	T		G
[mm]				[kg]
235.9	378	57	9I-1Z16-0298-0556	22
312.1	476	84	9I-1Z20-0390-0557	51
325.5	486	56	9I-1Z16-0415-0189	31
440.5	644	91.5	9I-1Z45-0550-1362	90
517	698	60	9I-1Z14-0626-1391	53.5
783	1065	85	9I-1Z25-0948-0373	181
785	1100	95	9I-1Z32-0955-0608	275
794	1095	100	9I-1Z30-0980-0434-2	256
806.2	1095	100	9I-1Z30-0980-0434	230
806.2	1095	100	9I-1Z30-0980-0434-1	230
840	1014	56	9I-1Z14-0944-1355	74
920	1145	92	9I-1Z30-1042-0335	180
940	1190	100	9I-1Z30-1090-0103	208
958	1225	90	9I-1Z30-1120-0356	244
960	1167	90	9I-1Z25-1075-0330	171
961	1175	90	9I-1Z25-1075-0300	170
992	1314	94	9I-1Z30-1198-0120	223
1080.4	1316	105.5	9I-1Z30-1202-0252	255
1140	1427	114	9I-1Z25-1315-0374	349
1160	1600	200	9I-1Z40-1432-29	1020
1160	1600	200	9I-1Z40-1432-29-3	1020
1231	1600	95	9I-1Z30-1437-52	431
1299.7	1600.2	127	9I-1Z36-1456-0792	490
1375	1760	150	9I-1Z40-1608-0192	712
1375	1760	150	9I-1Z40-1608-0192-1	723
1375	1760	150	9I-1Z40-1608-1396	720
1416	1770	132	9I-1Z32-1604-1304	671
1428	1718	109	9I-1Z25-1605-0785	417
1714.5	2170	160	9I-1Z50-1992-1214	1428



Double-row

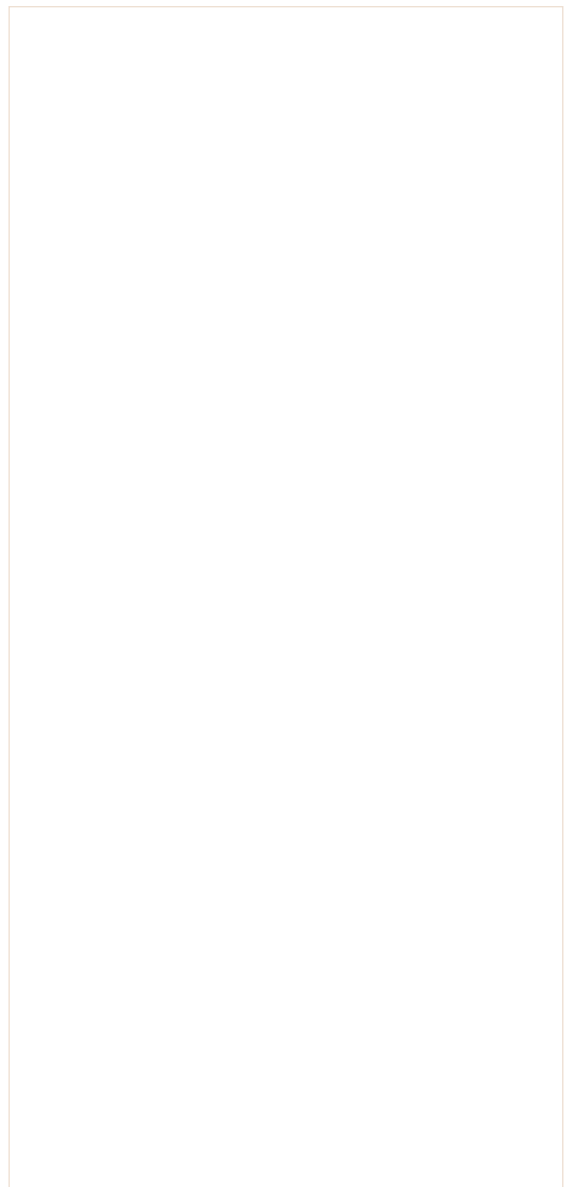
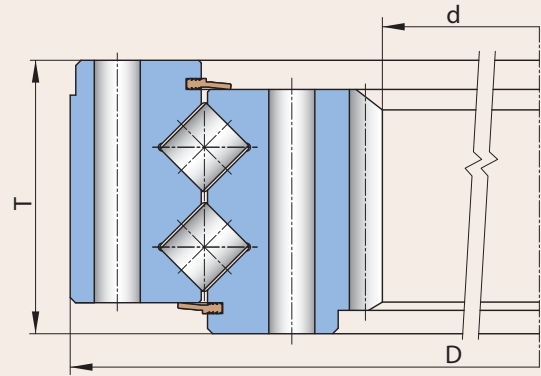

# SPECIAL AXIAL-RADIAL ROLLER SLEWING RINGS

Double-row with inner gear

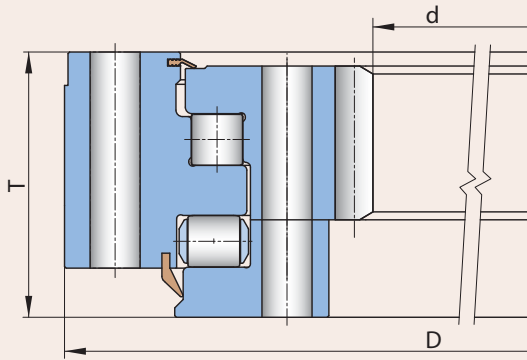

Triple-row without gear

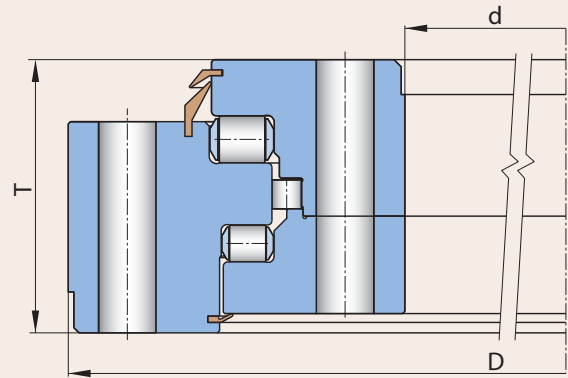

Double-row with inner gear

Boundary Dimensions			Designation	Weight
d	D	T		
[mm]				[kg]
1198.9	1623	194.6	9I-2R40-1422-0780 *	1042
1210.9	1585.5	161.9	9I-2R32-1405-0839 **	760
1452.9	1898	194.6	9I-2R40-1697-0990	1334

Triple-row without gear

Boundary Dimensions			Designation	Weight
d	D	T		
[mm]				[kg]
568.5	909.3	147	90-3R16-0715-1058	363
665	1065	147	90-3R16-0850-1017	490
1328	1767	194	90-3R36-1543-1096	1265
2680	3200	220	90-3R40-2930-1237	3420

Notes:  
 \* Original designation 9I-2Z40-1422-0780  
 \*\* Original designation 9I-2Z32-1405-0839

Triple-row with external gear

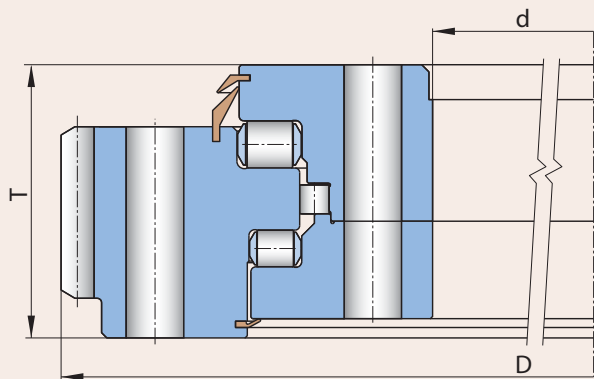

Triple-row with internal gear

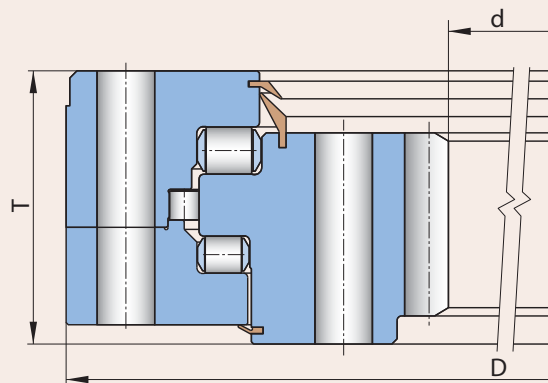

Triple-row with external gear

Boundary Dimensions			Designation	Weight G
d	D	T		
[mm]				[kg]
1140.9	1493.5	140	9E-3R25-1291-1177	563
1150	1604	118	9E-3R20-1375-1046	663
1945	2534.4	250	9E-3R45-2193-1159	2880

Triple-row with internal gear

Boundary Dimensions			Designation	Weight G
d	D	T		
[mm]				[kg]
1275.1	1790.7	219	9I-3R40-1574-0916	1503
1784.5	2245	165	9I-3R32-2048-1154	1396
1837	2330	180	9I-3R28-2140-1314	1665
1840	2330	180	9I-3R32-2140-1305	1745
1856	2330	180	9I-3R28-2140-1018	1640
1856	2330	180	9I-3R28-2140-1018-1	1640
2568	3168	190	9I-3R28-2910-1098	2842

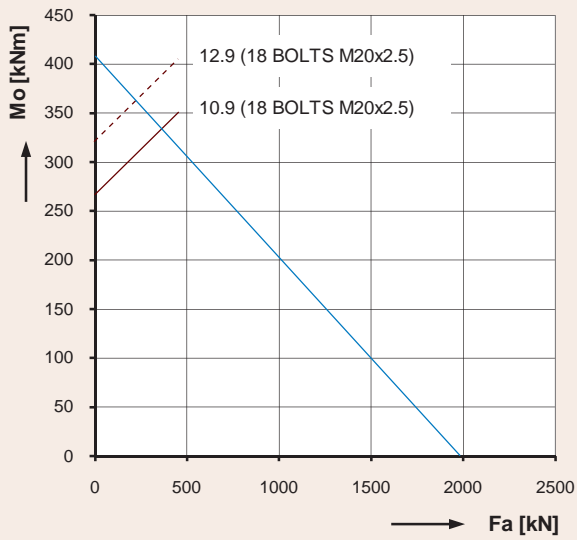

9E-1Z30-0823-15

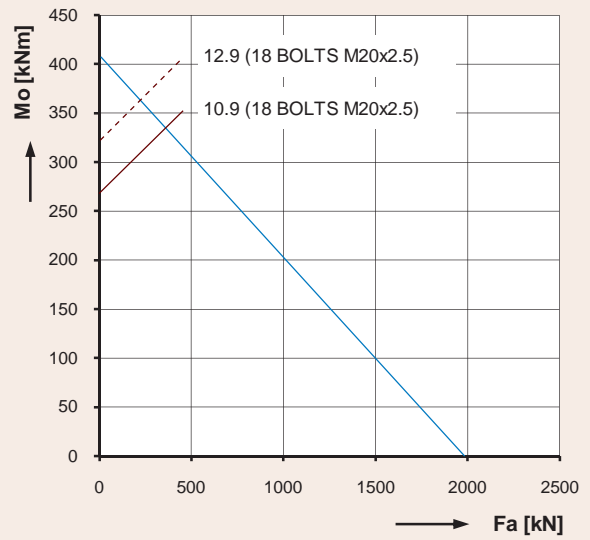

9E-1Z30-0823-15-1

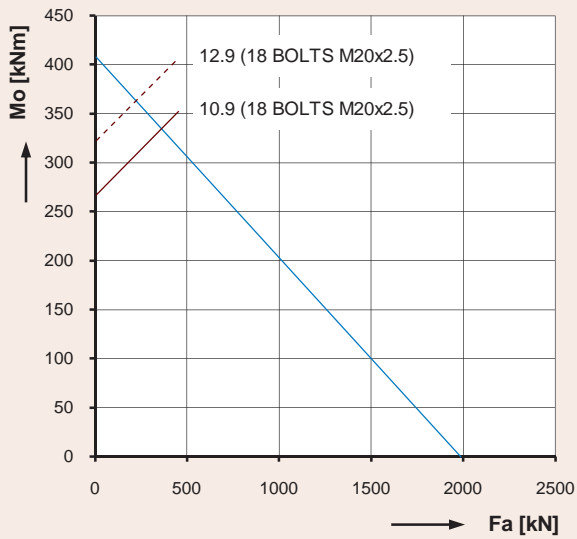

9E-1Z30-0823-15-2

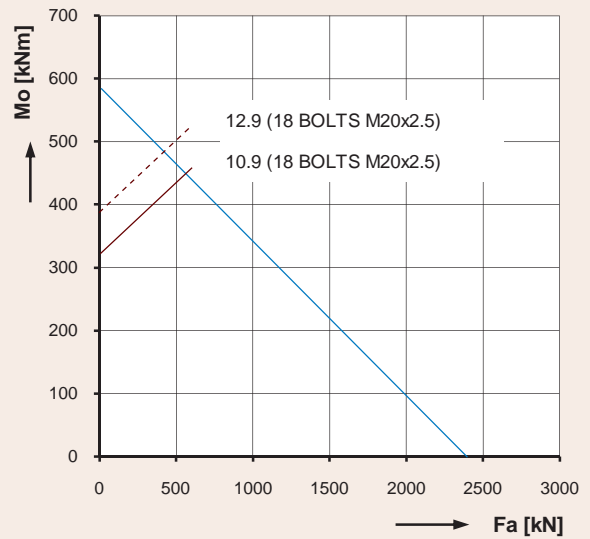

9E-1Z30-0980-16

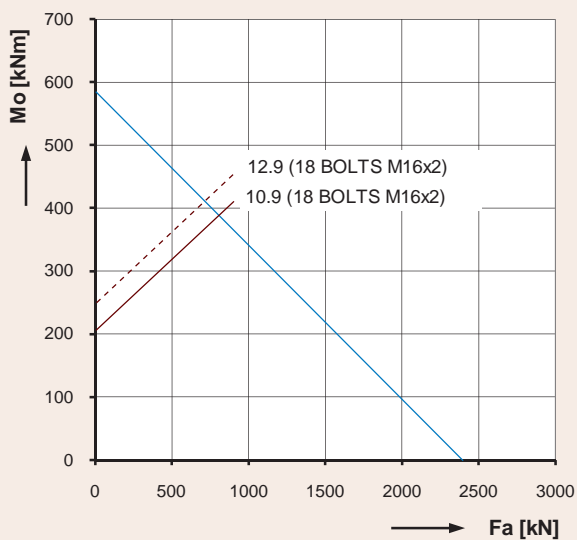

9E-1Z30-0980-16-8

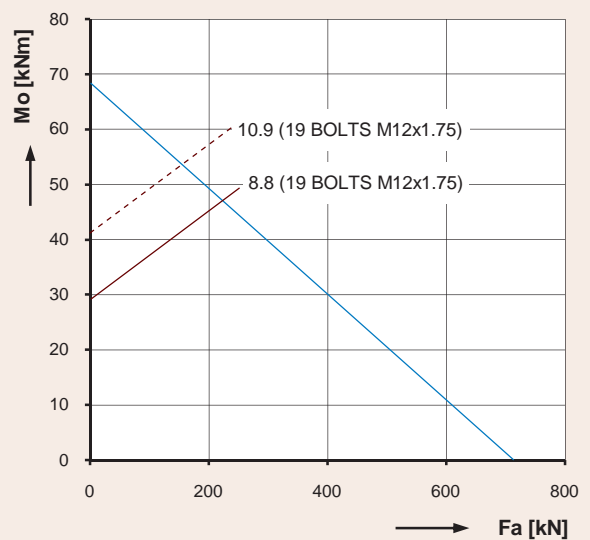

9E-1Z25-0384-18-1

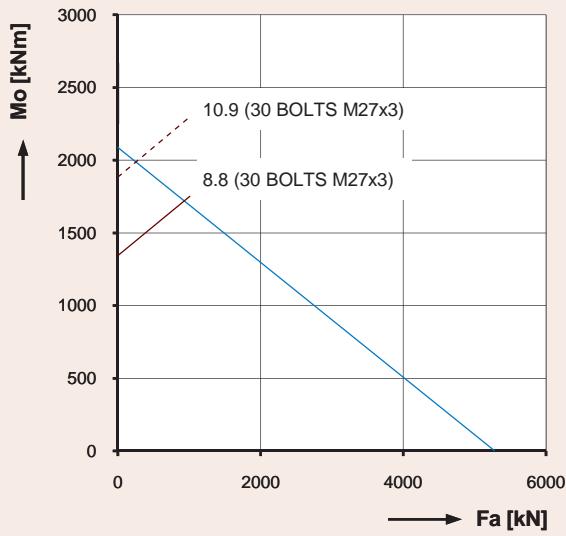

9E-1Z40-1584-26

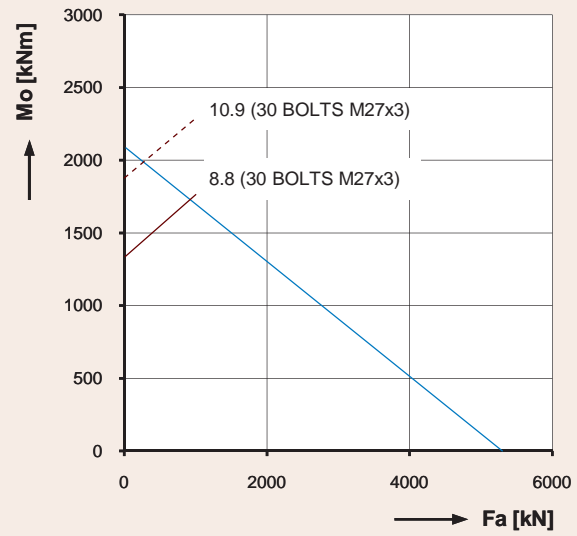

9E-1Z40-1584-26-3

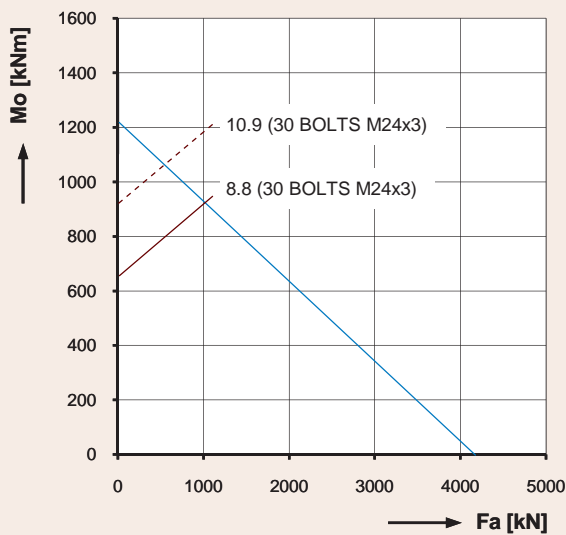

9I-1Z40-1175-30

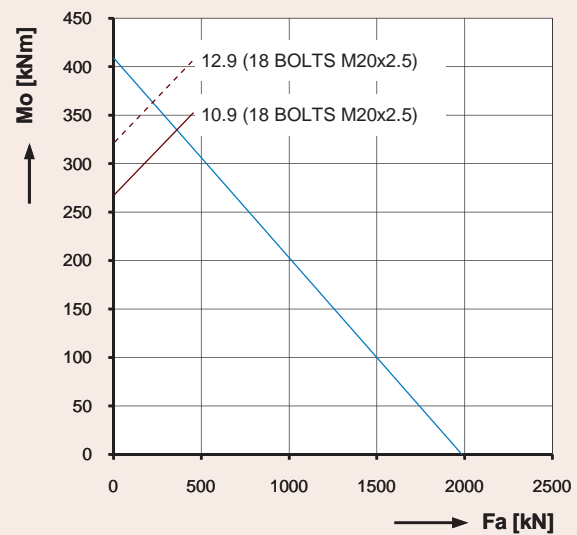

9E-1Z30-0823-37

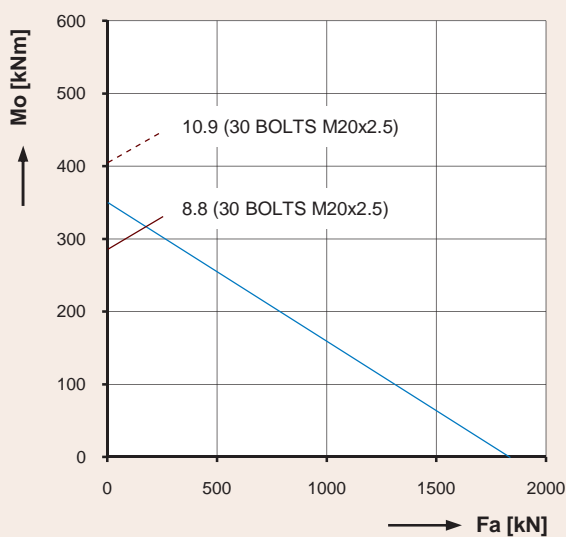

9O-1Z30-0766-38

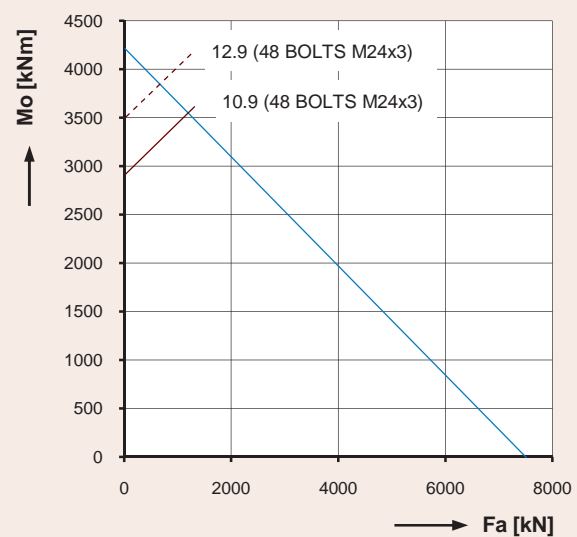

9O-1Z40-2248-55

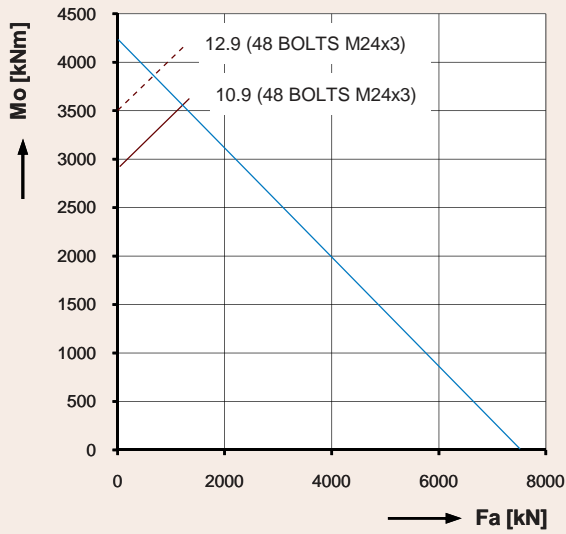

90-1Z40-2248-55-1

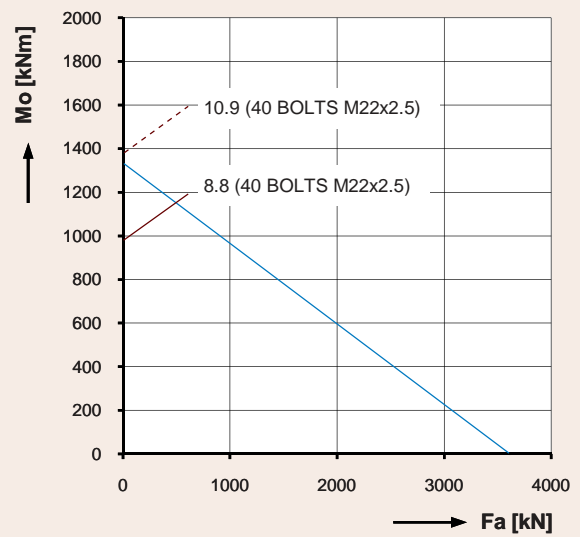

9E-1Z30-1473-78

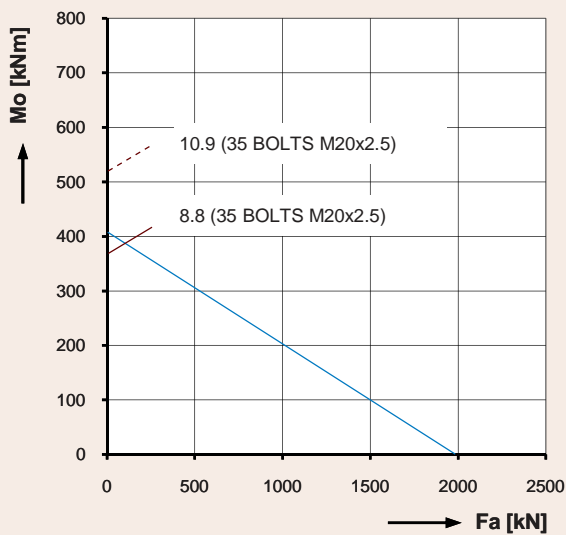

9E-1Z30-0823-80

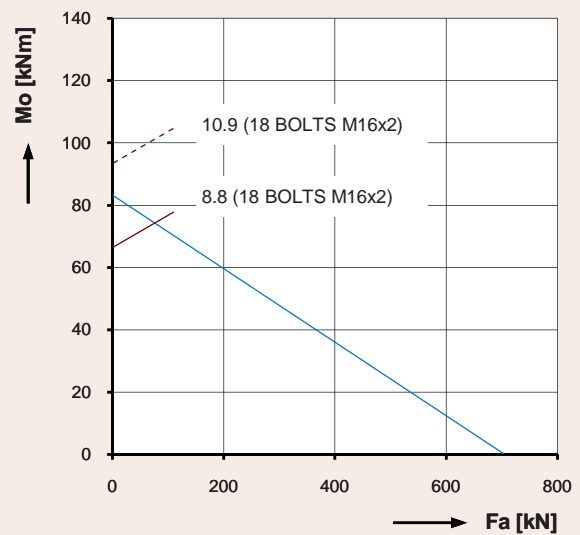

9E-1Z20-0474-0100

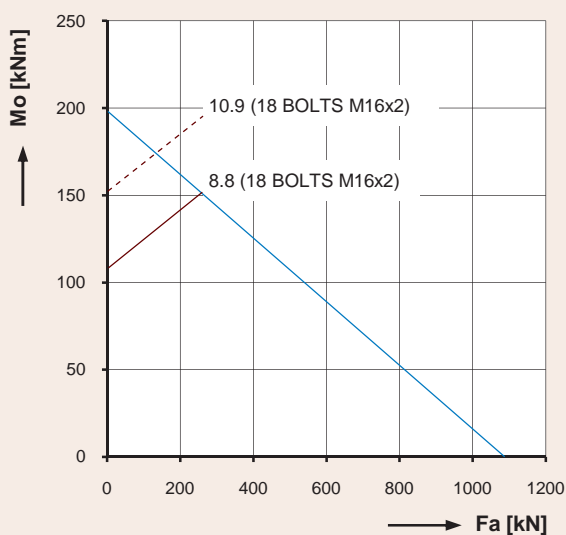

9E-1Z20-0730-0101

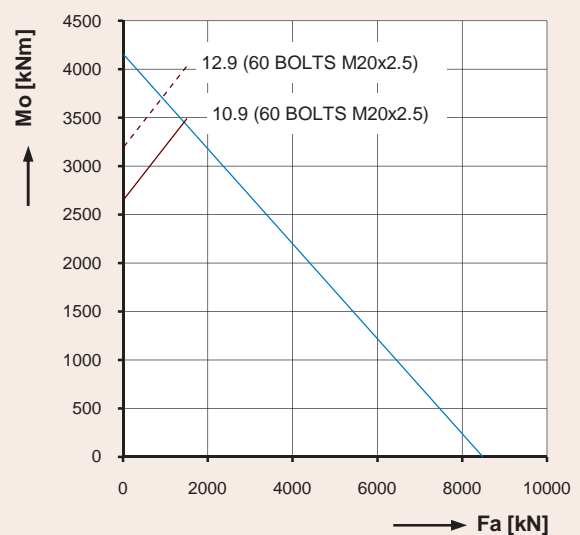

90-1B25-2300-0107

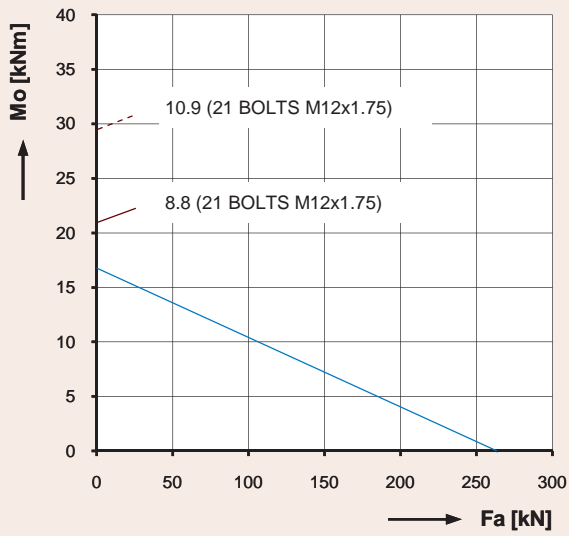

9E-1Z14-0254-0110

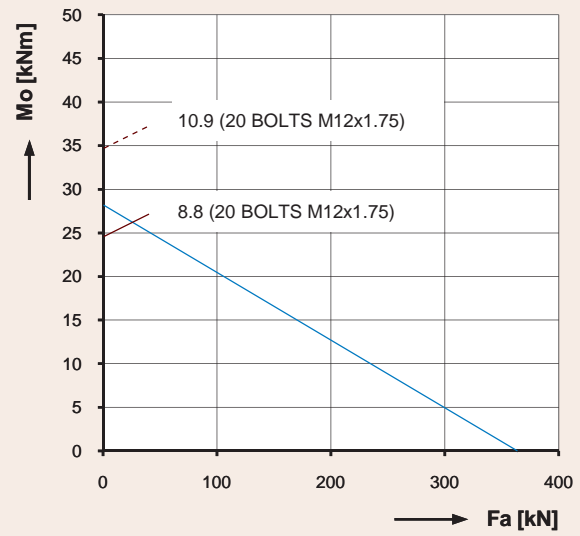

9E-1Z16-0310-0111-3

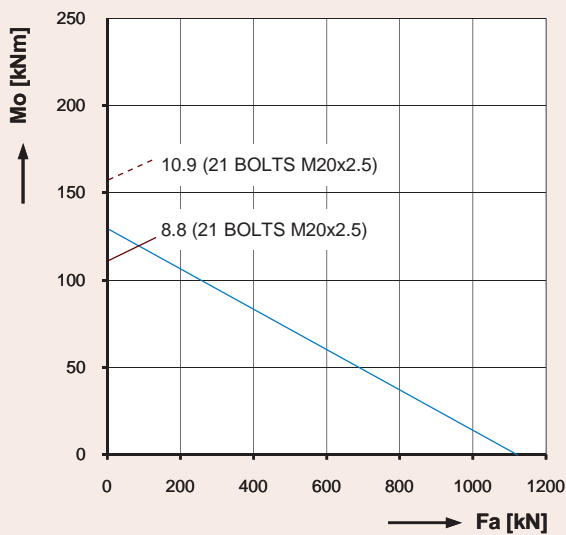

9E-1Z30-0461-0119

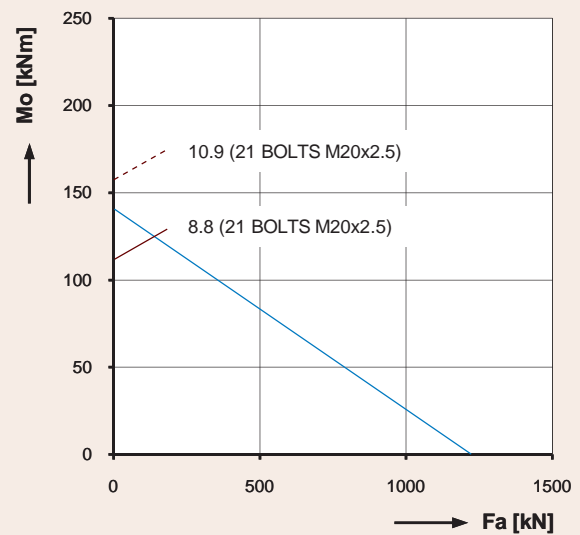

9O-1Z30-0461-0125

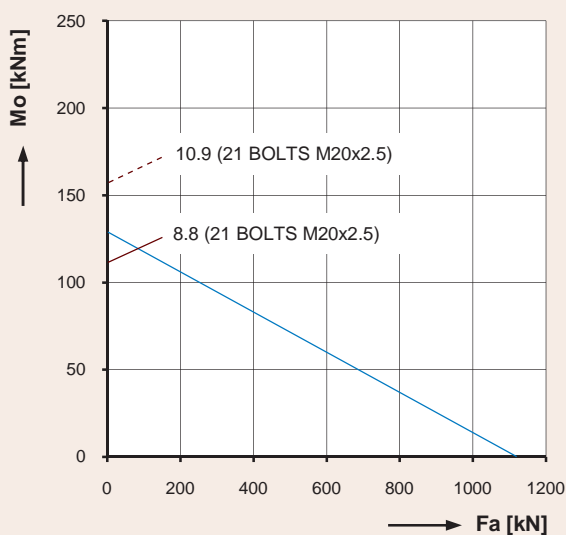

9E-1Z30-0461-0126

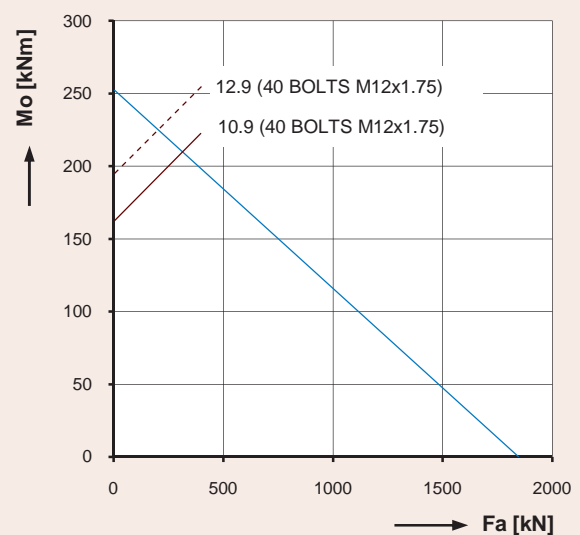

9I-1B20-0644-0135

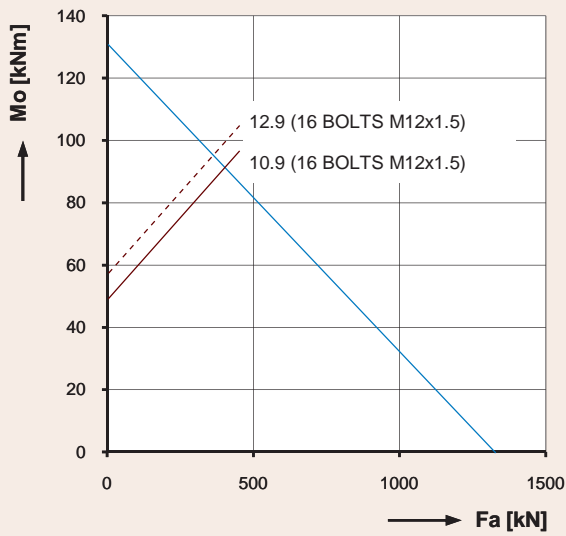

9I-1B20-0465-0136

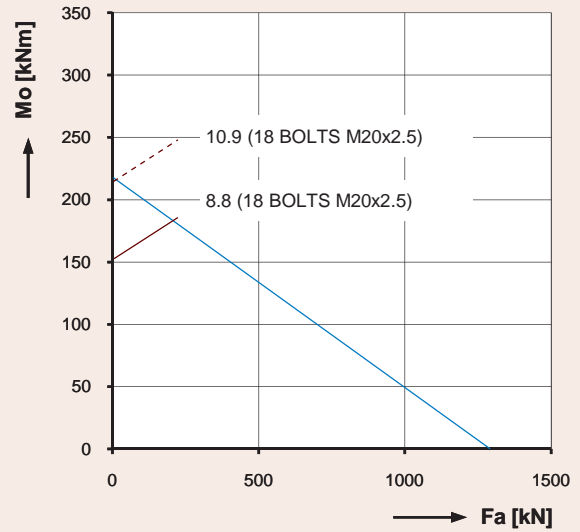

9E-1Z25-0675-0145

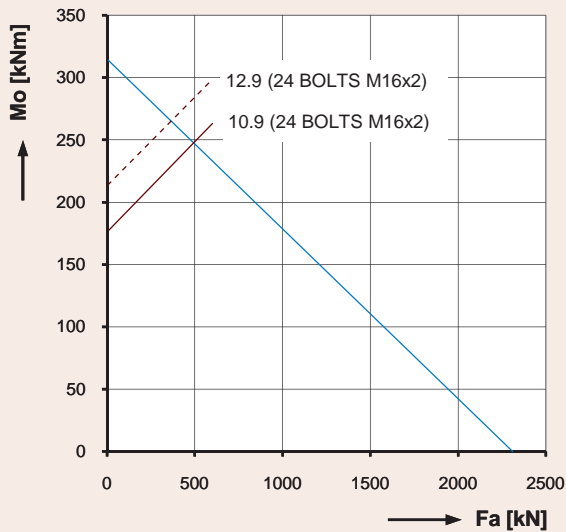

9E-1B25-0640-0150

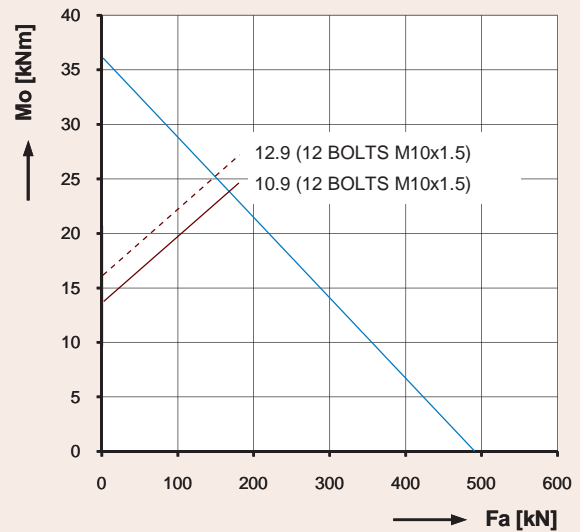

9O-1Z20-0295-0151

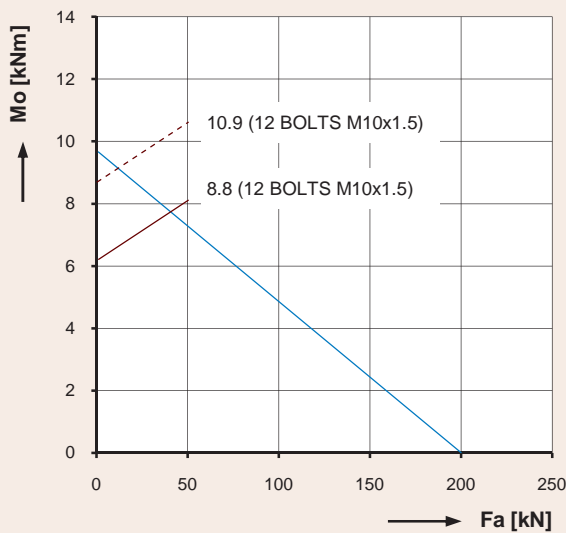

9O-1Z14-0193-0152

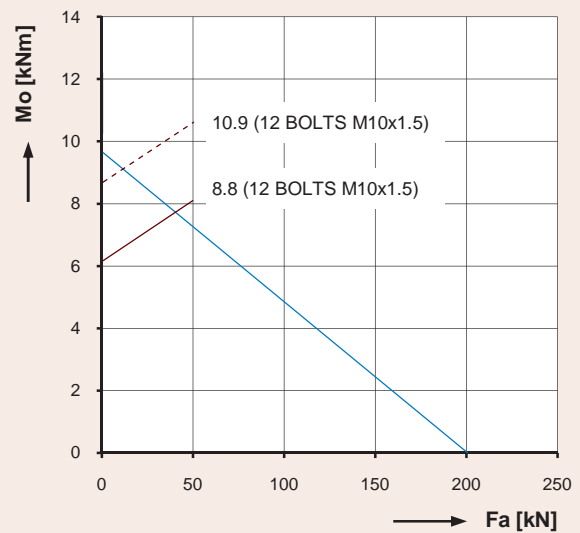

9O-1Z14-0193-0152-1



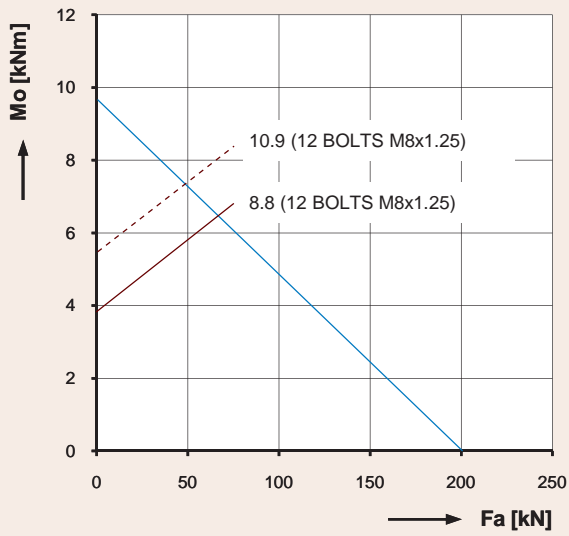

9O-1Z14-0193-0152-2

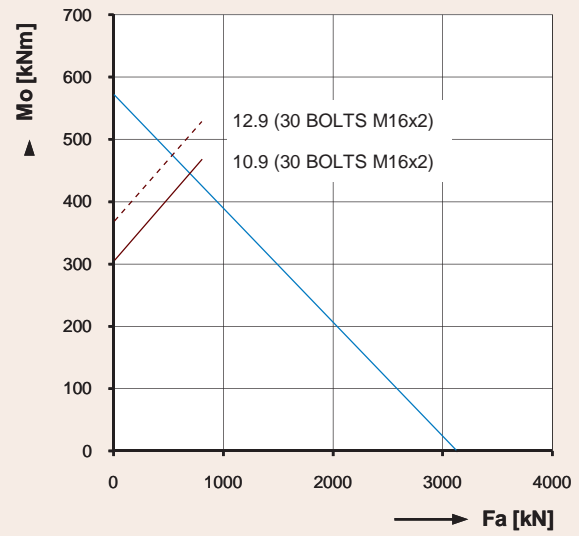

9I-1B25-0860-0157

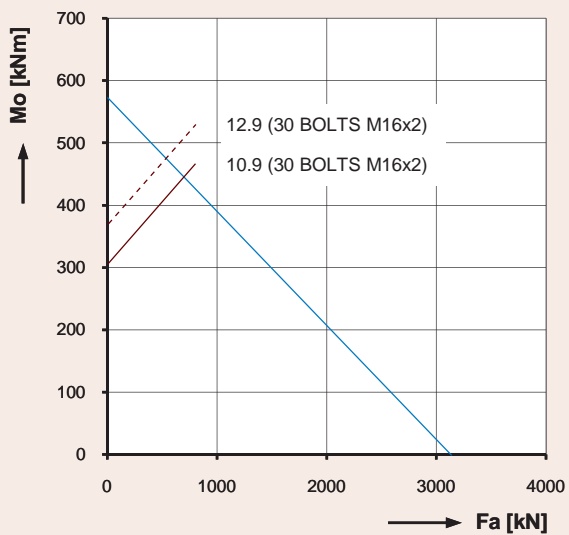

9I-1B25-0860-0157-1

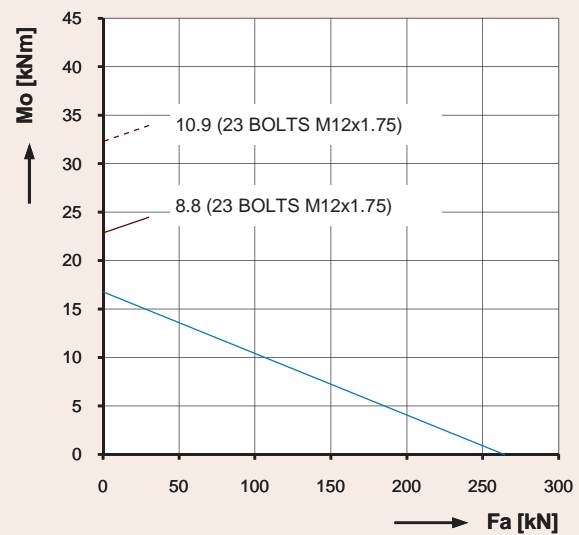

9O-1Z14-0254-0168-1

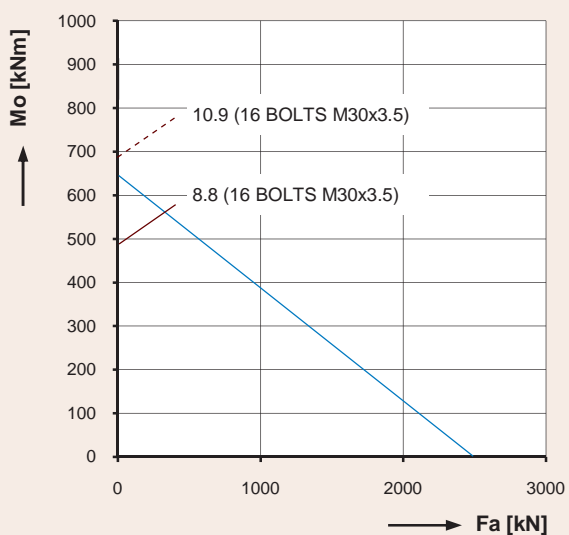

9I-1Z30-1035-0174

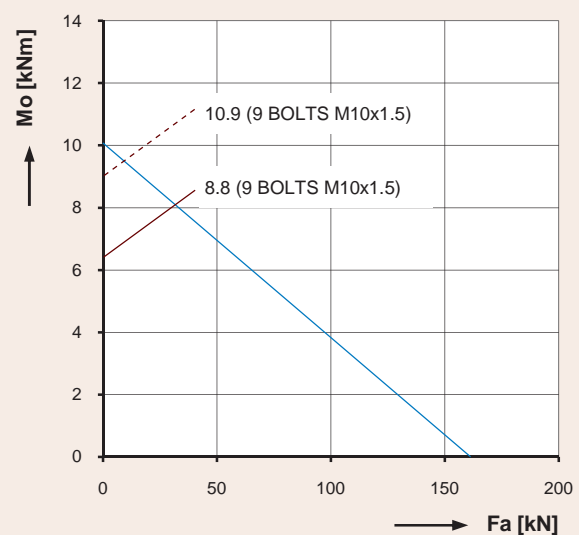

9O-1Z10-0250-0176-2

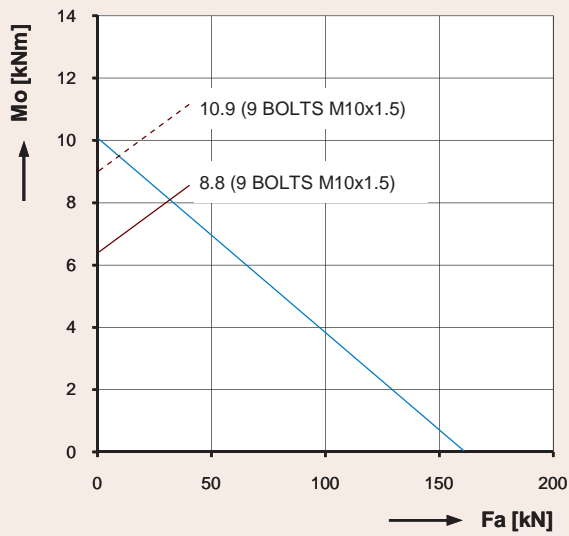

9O-1Z10-0250-0176-3

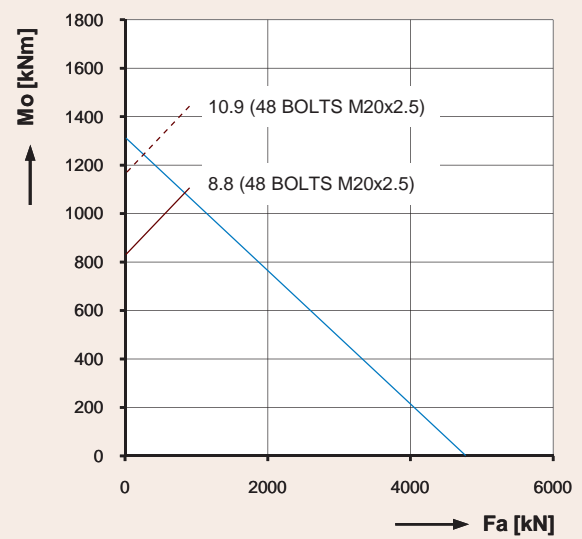

9I-1B25-1296-0180

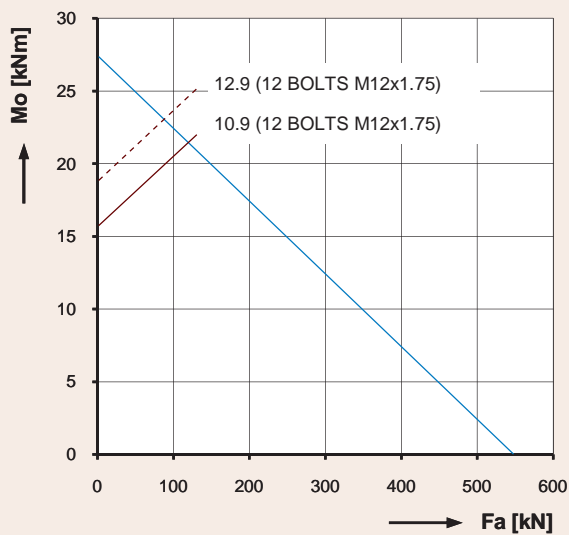

9E-1B17-0235-0182

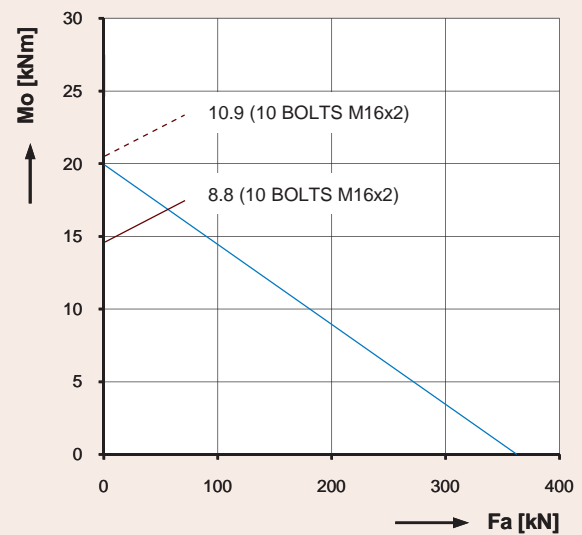

90-1Z20-0220-0184

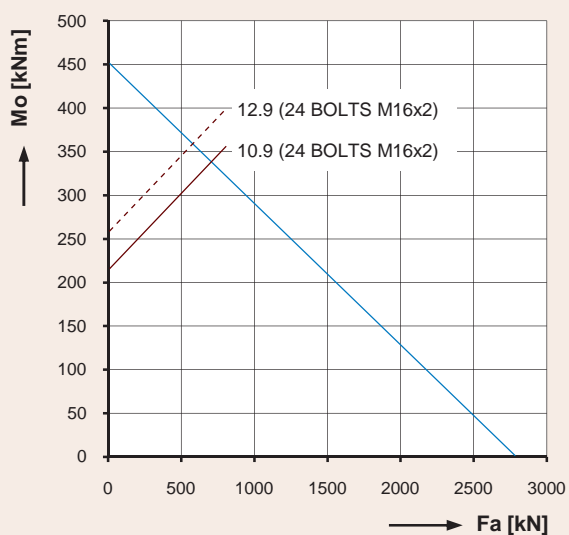

9I-1B25-0763-0186

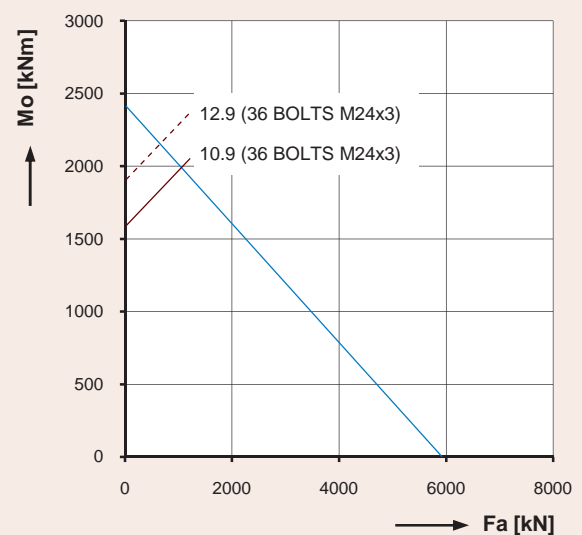

9I-1Z40-1632-0194

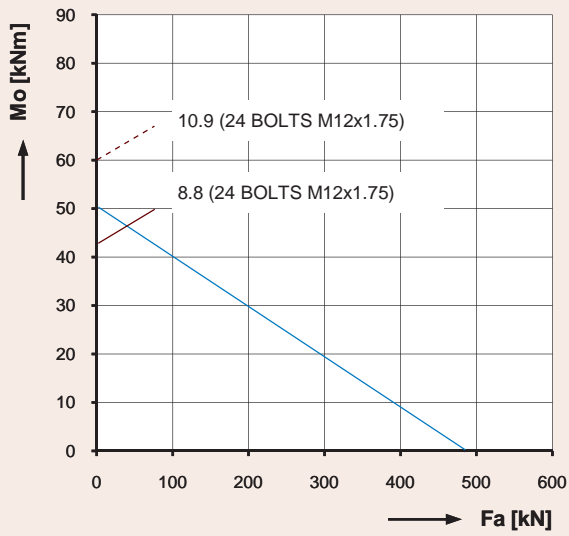

9I-1Z16-0415-0196

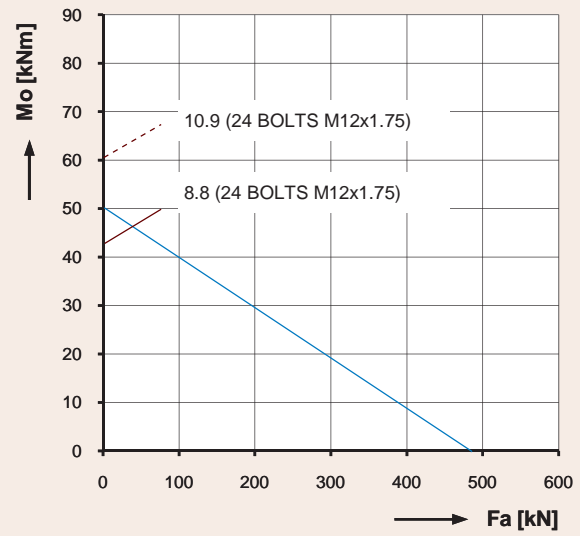

9I-1Z16-0415-0196-1

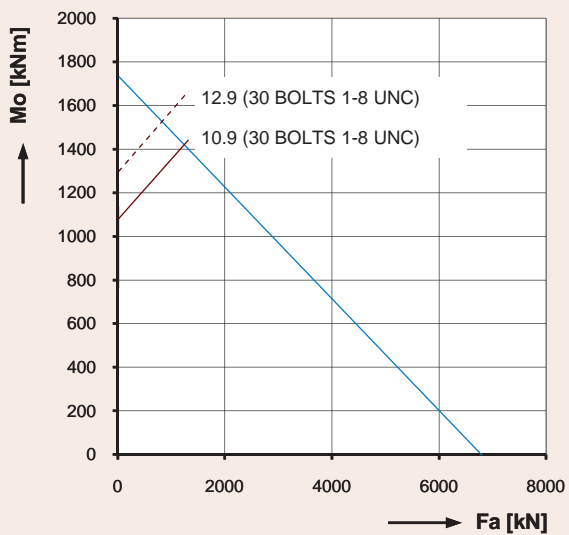

9I-1B40-1204-0197

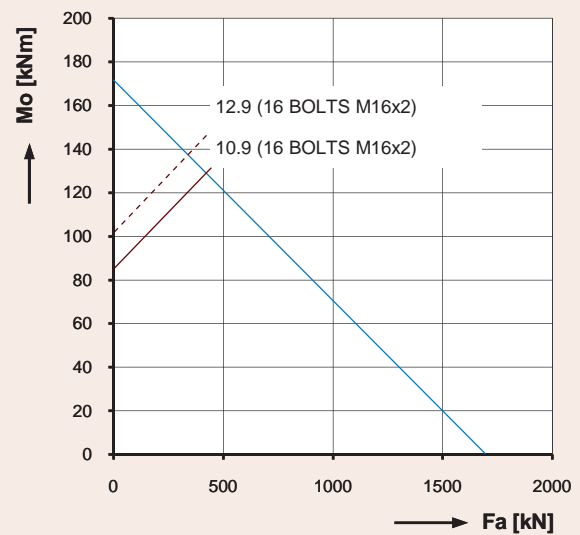

9I-1B32-0897-0198

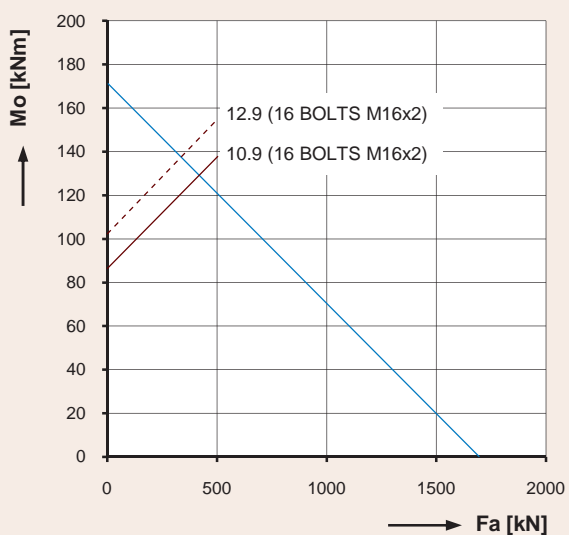

9O-1B25-0475-0204

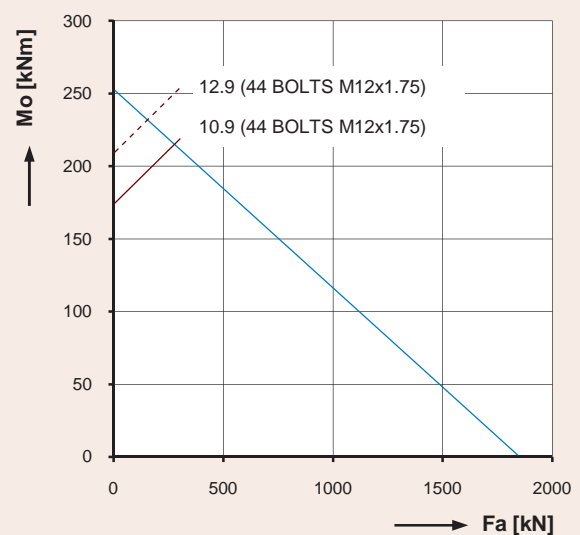

9E-1B20-0644-0208

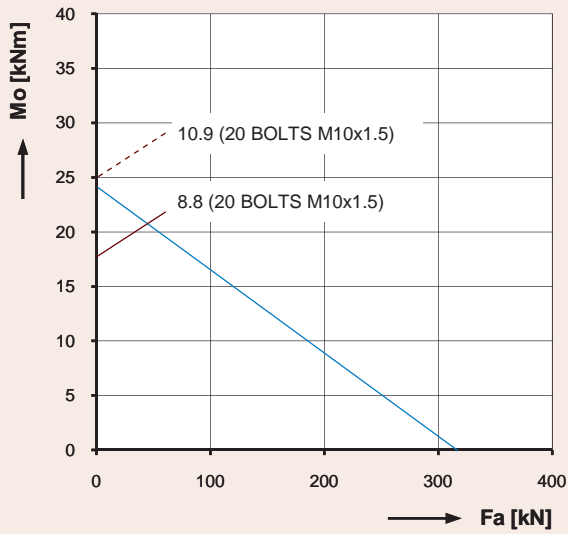

9O-1Z14-0305-0218

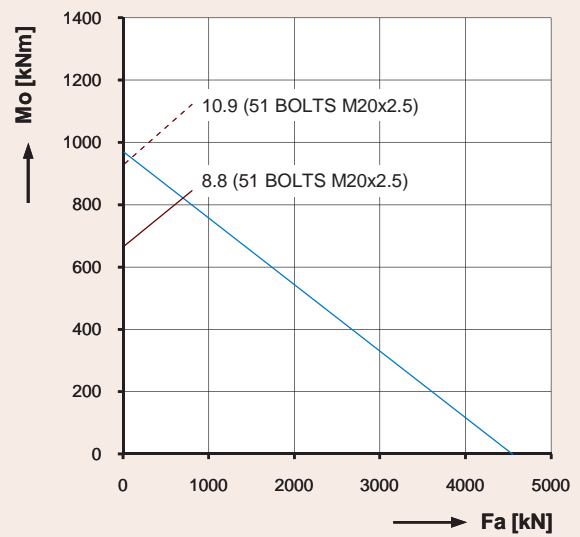

9E-1B32-1000-0223

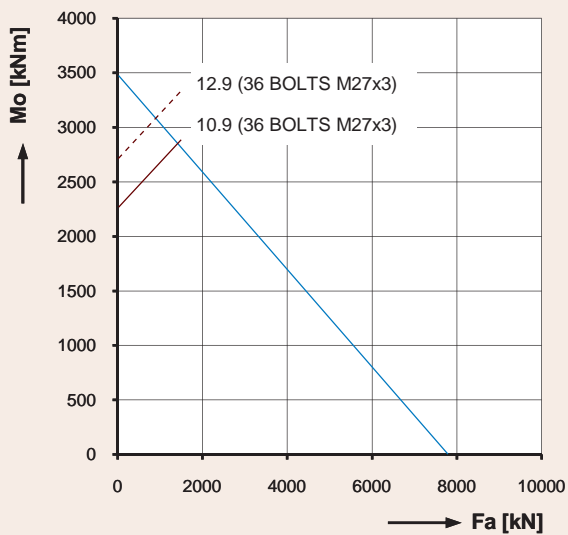

9E-1Z50-1790-0232

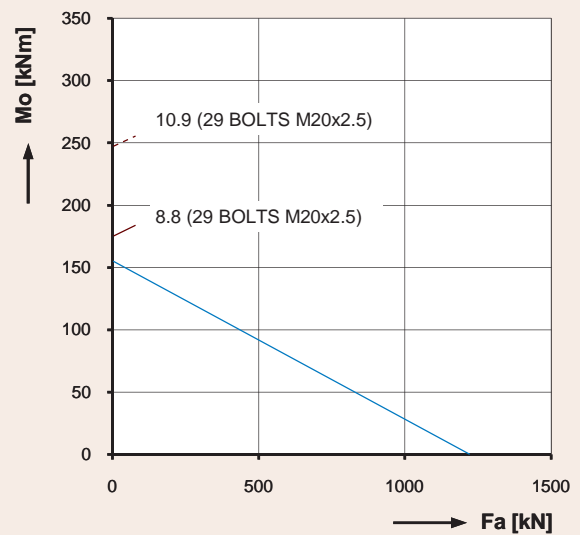

9E-1Z30-0508-0236

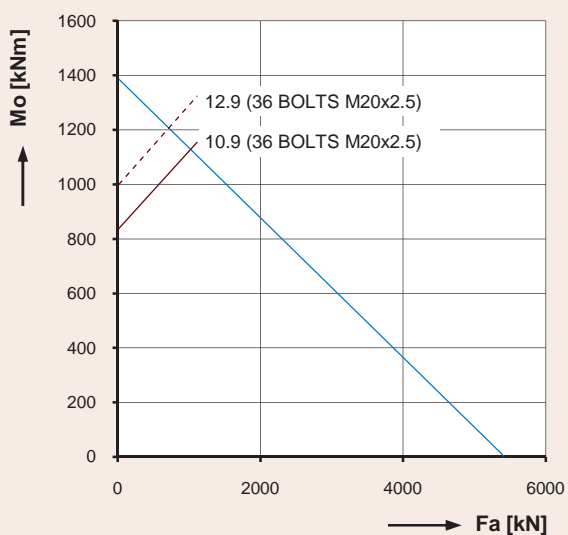

9I-1B30-1205-0251

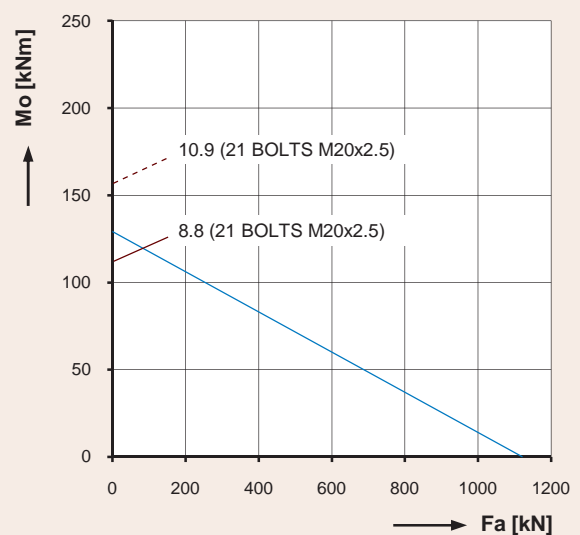

9O-1Z30-0461-0260

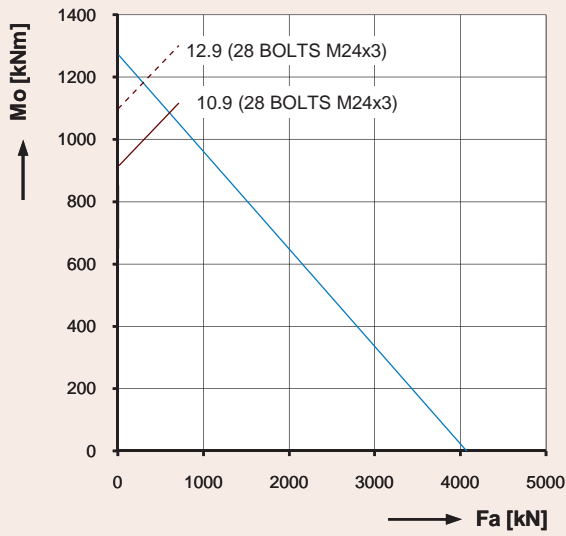

9E-1Z40-1250-0263

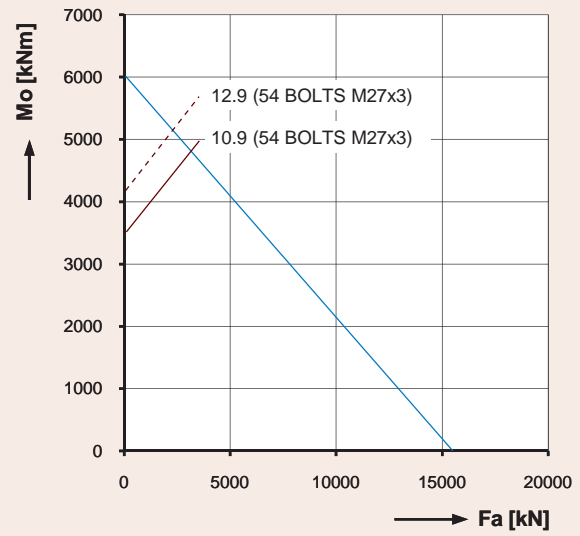

9I-1B60-1830-0267

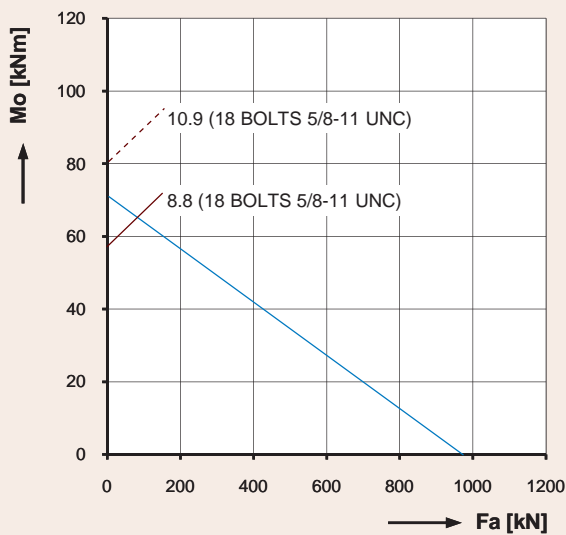

9E-1B20-0345-0273

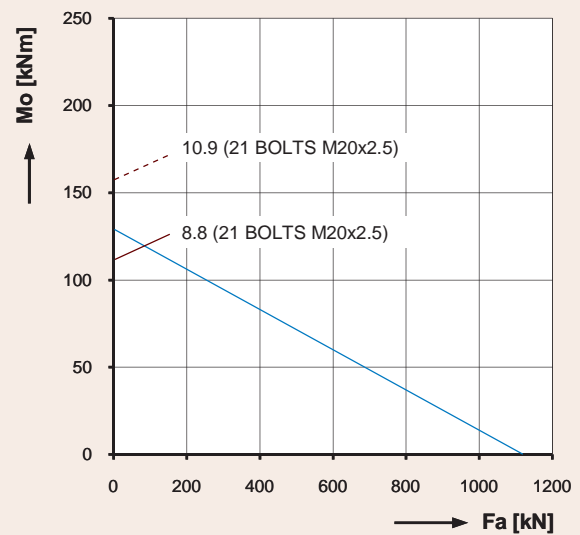

9O-1Z30-0461-0278

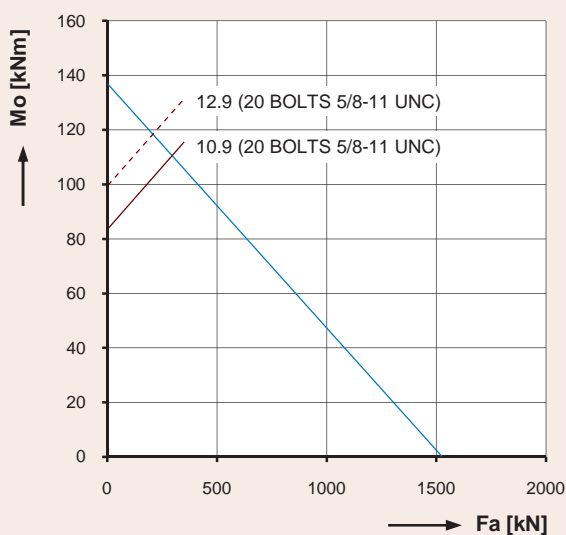

9E-1B25-0422-0285

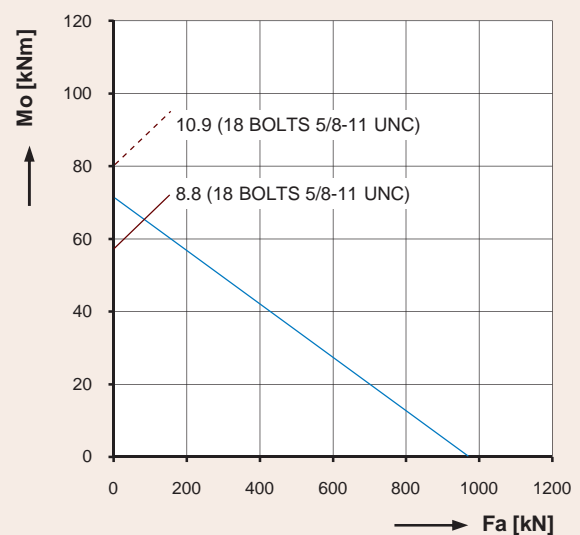

9E-1B20-0345-0286

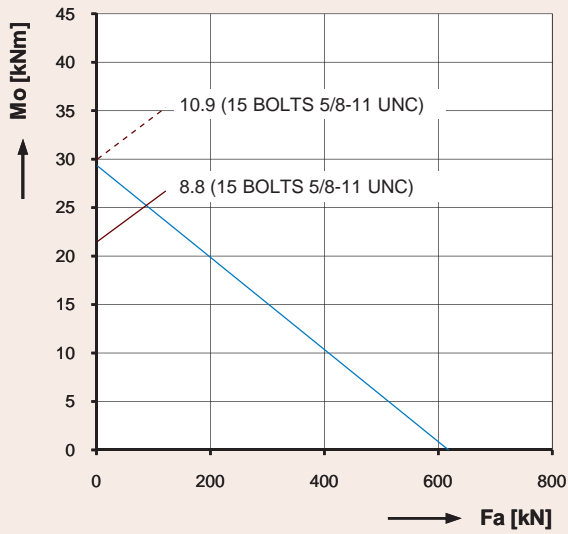

9E-1B20-0223-0287

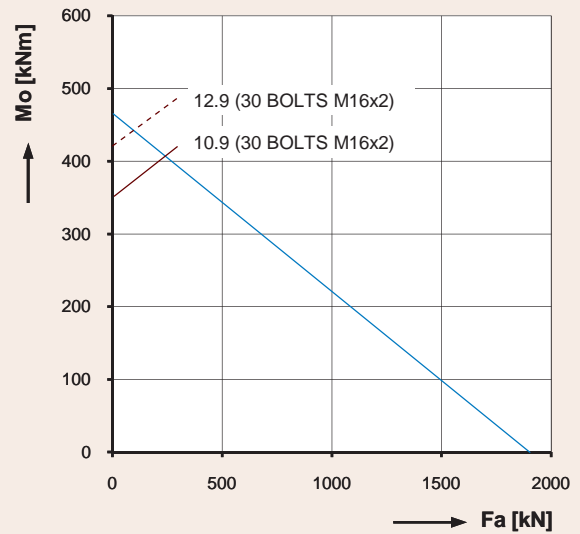

9E-1Z25-0980-0294

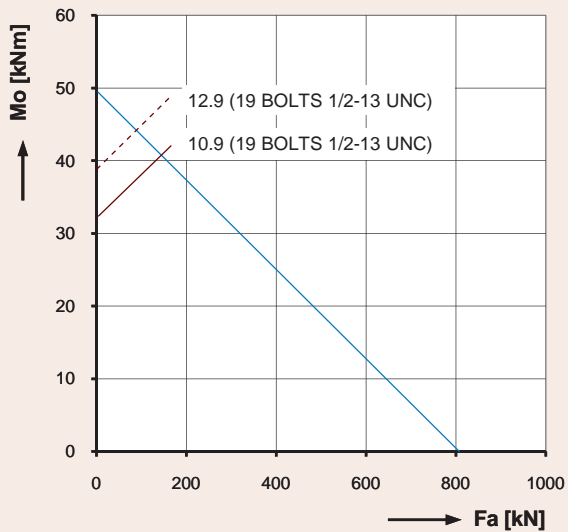

9O-1B20-0289-0295

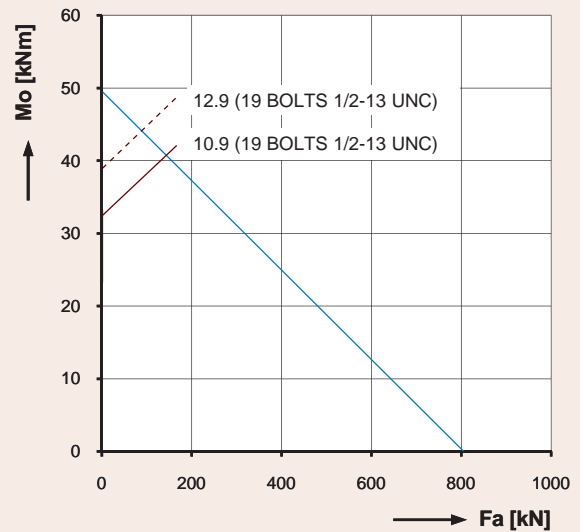

9O-1B20-0289-0295-1

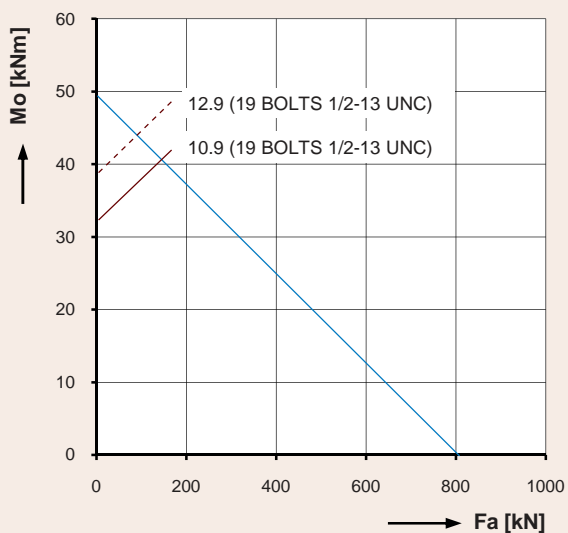

9O-1B20-0289-0295-3

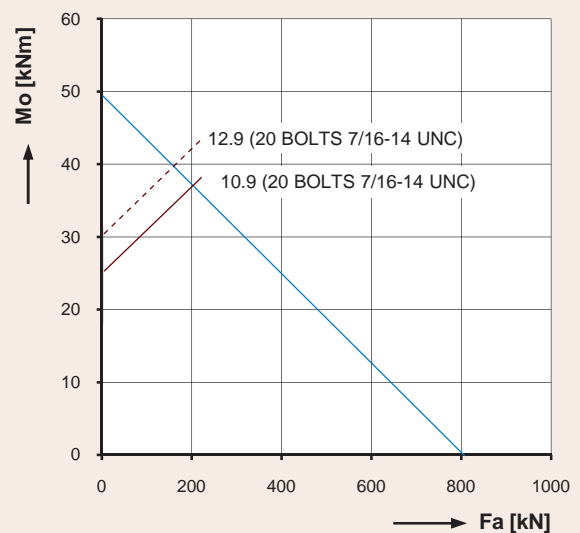

9O-1B20-0289-0295-4

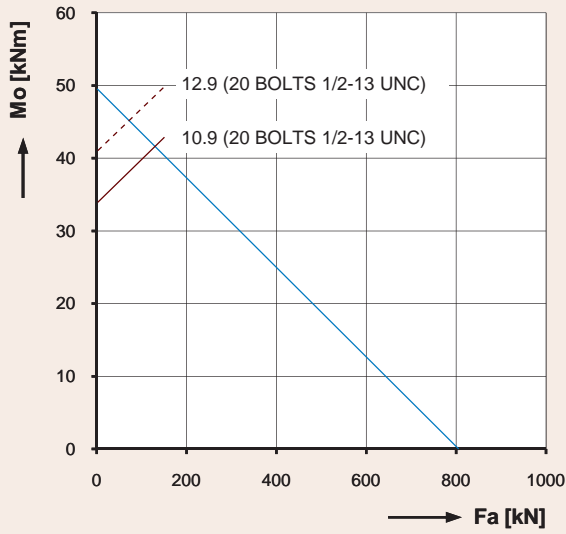

9O-1B20-0289-0295-5

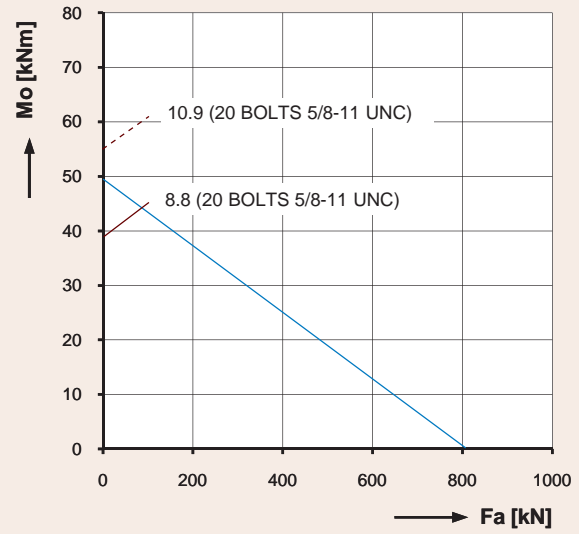

9O-1B20-0289-0295-6

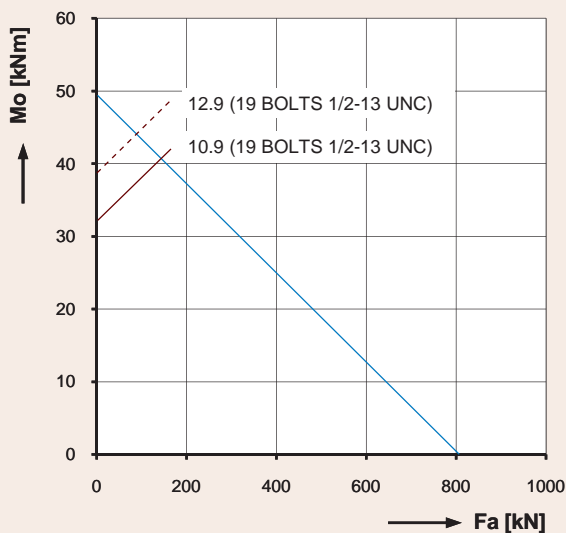

9O-1B20-0289-0295-7

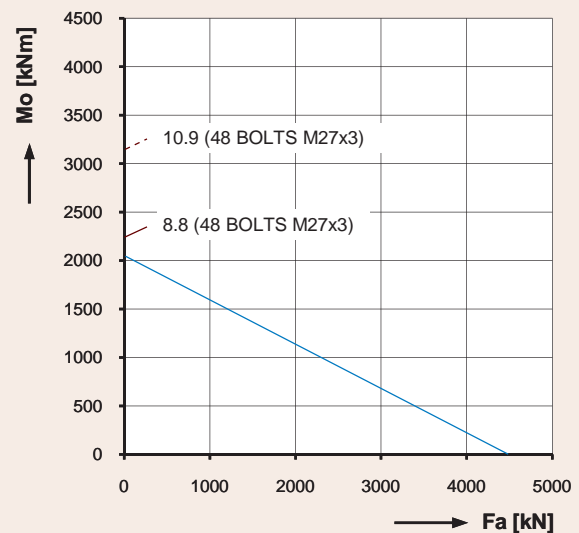

9E-1Z30-1830-0297

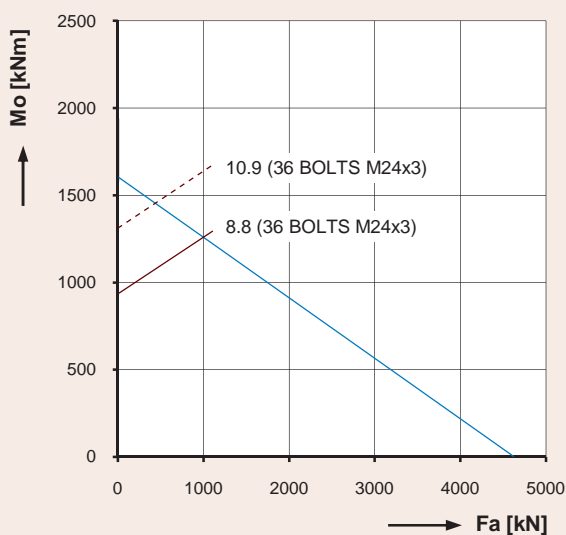

9I-1Z40-1385-0301

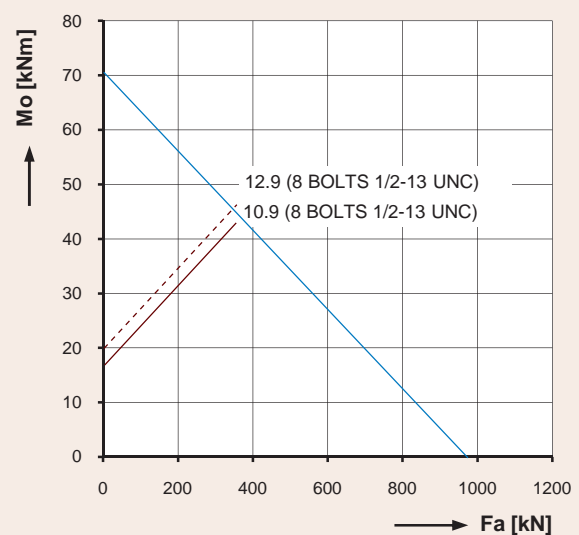

9E-1B20-0343-0311

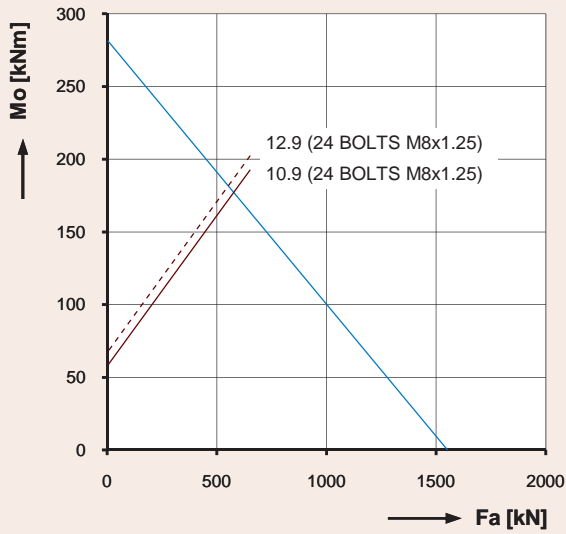

90-1B13-0854-0313

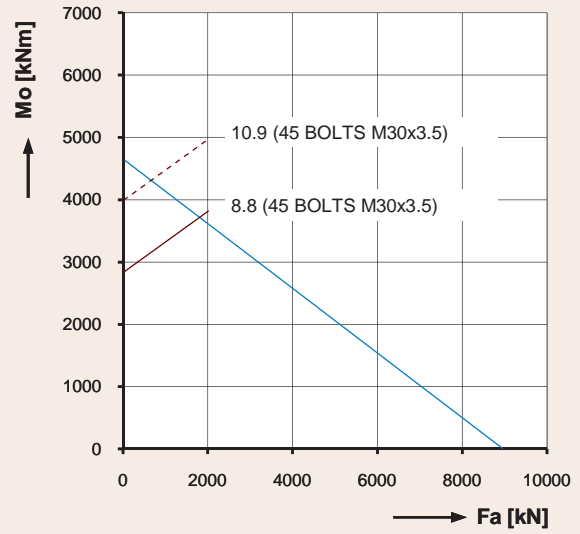

90-1Z50-2071-0315

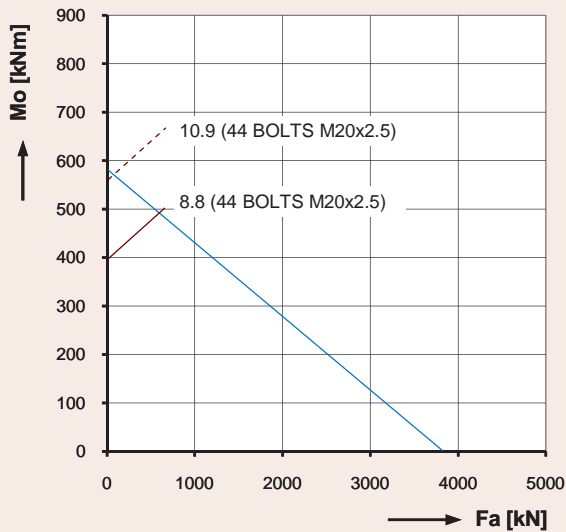

9I-1B36-0715-0317

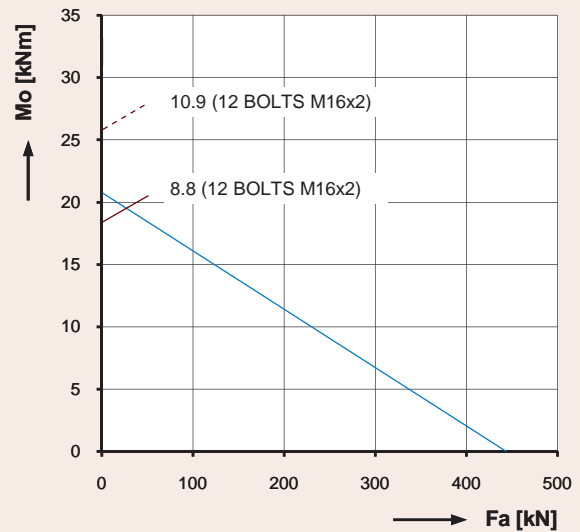

90-1B13-0220-0318

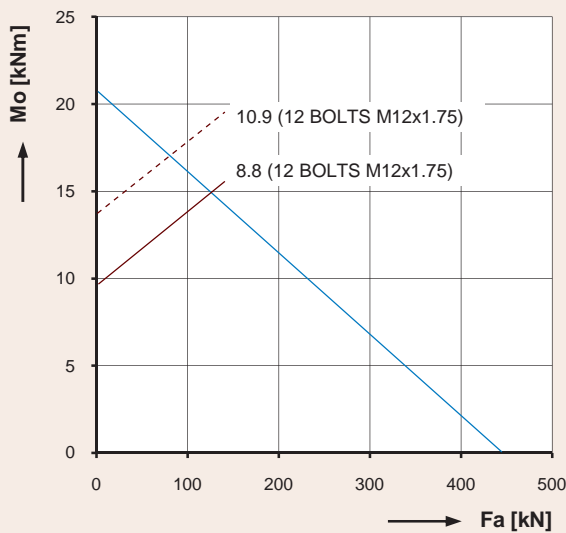

90-1B13-0220-0318-1

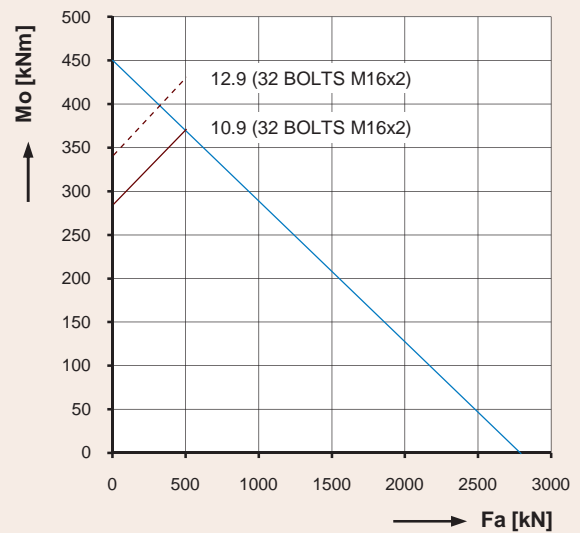

9E-1B25-0762-0321



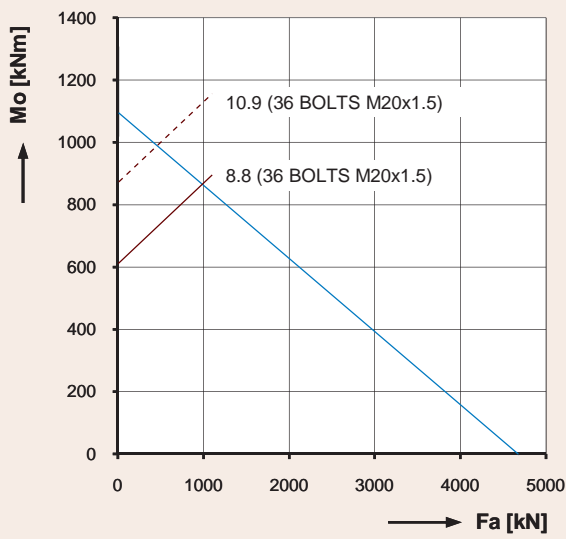

9I-1B29-1103-0323

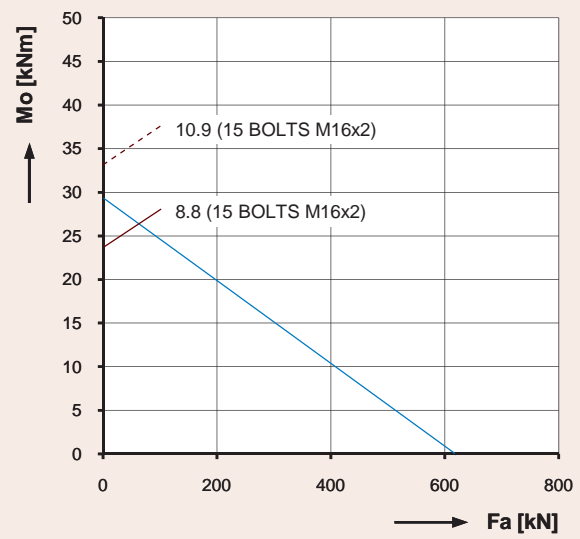

9O-1B20-0223-0326

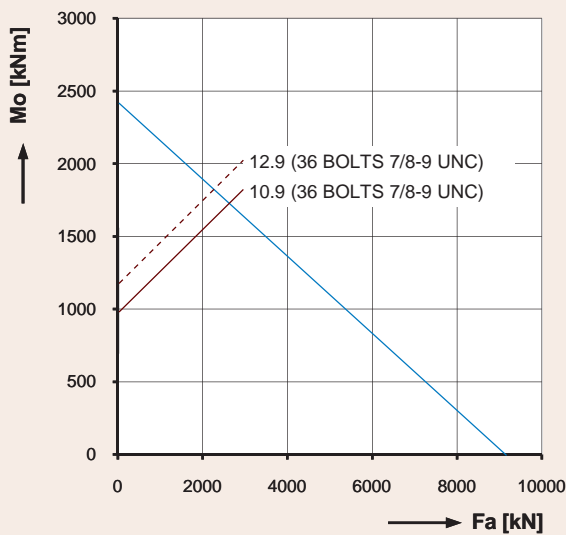

9I-1B50-1234-0327

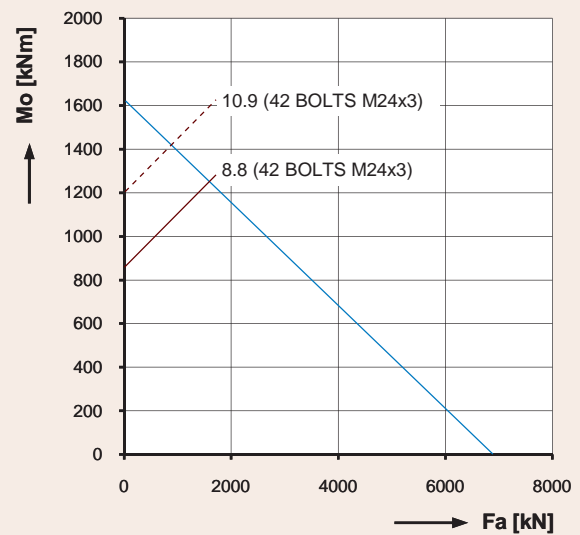

9E-1B45-1105-0329

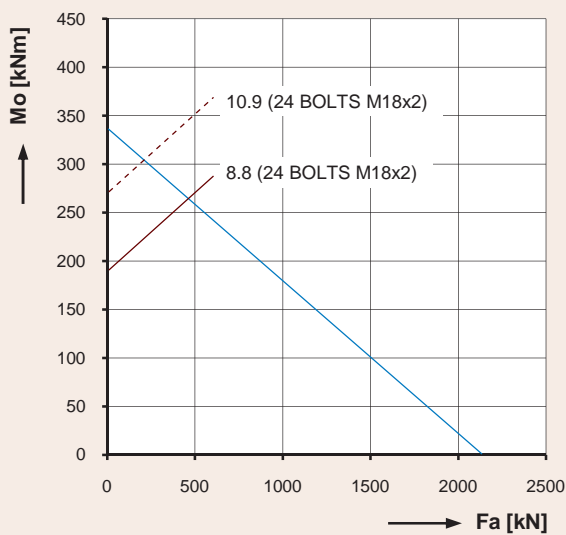

9O-1B20-0744-0341

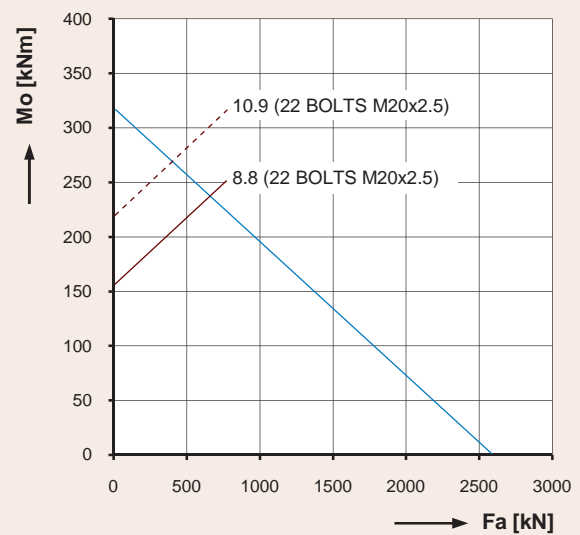

9O-1B32-0580-0342

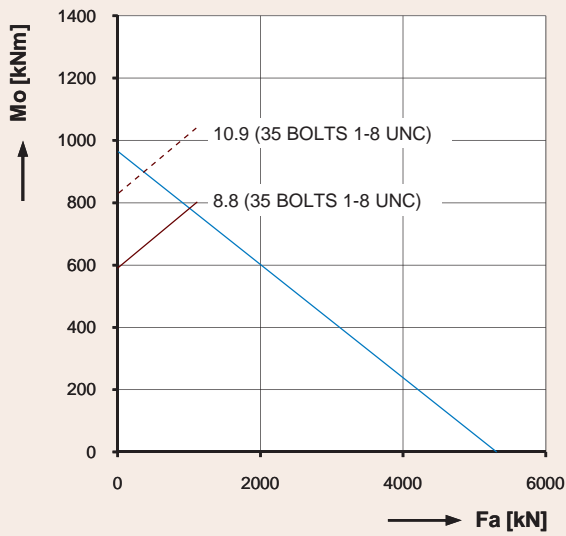

9E-1B45-0854-0343-1

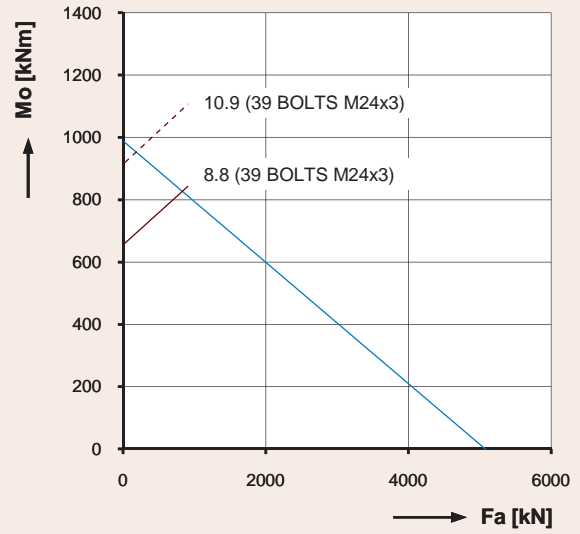

9E-1B40-0910-0345

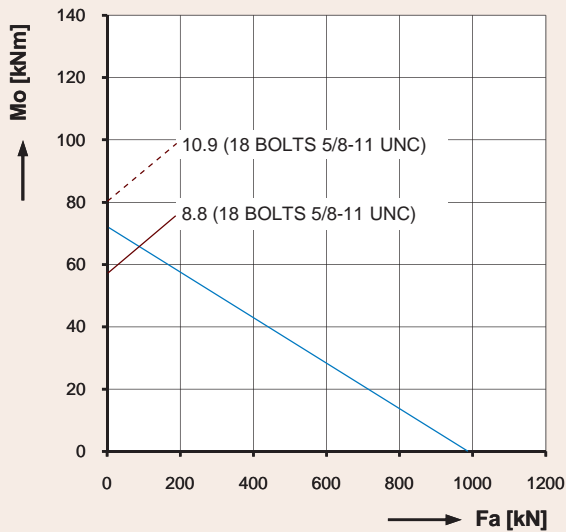

9I-1B20-0342-0351

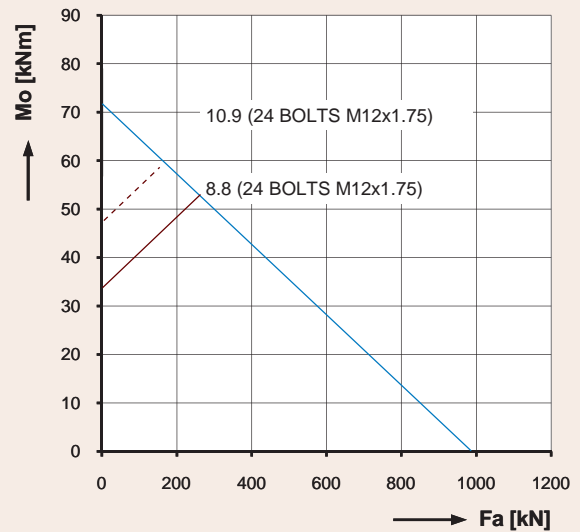

9I-1B20-0342-0351-4

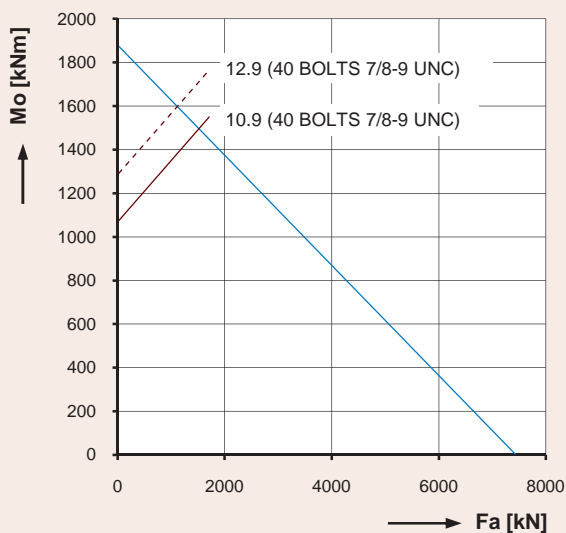

9I-1B45-1187-0352

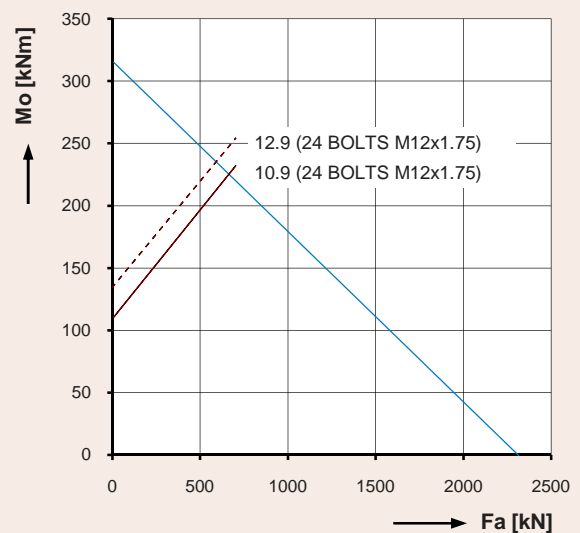

9O-1B25-0640-0355

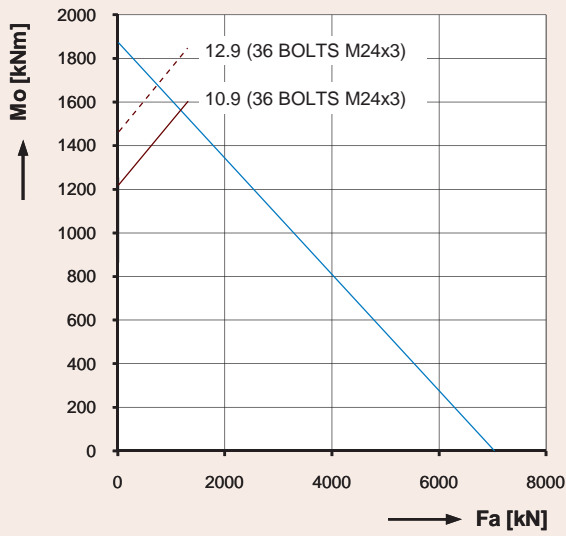

9I-1B40-1252-0364

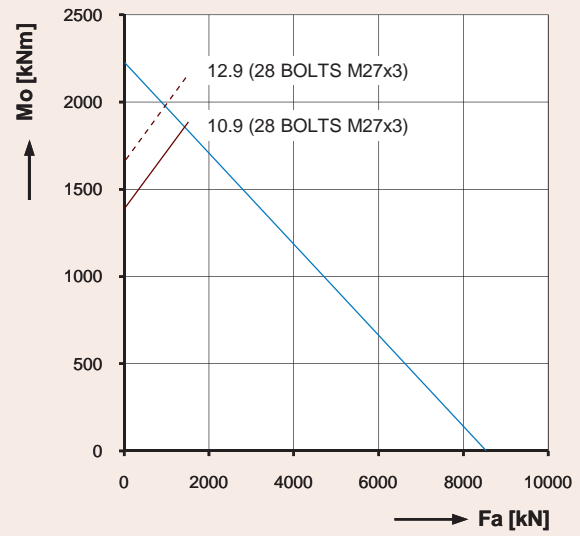

9E-1B50-1224-0370

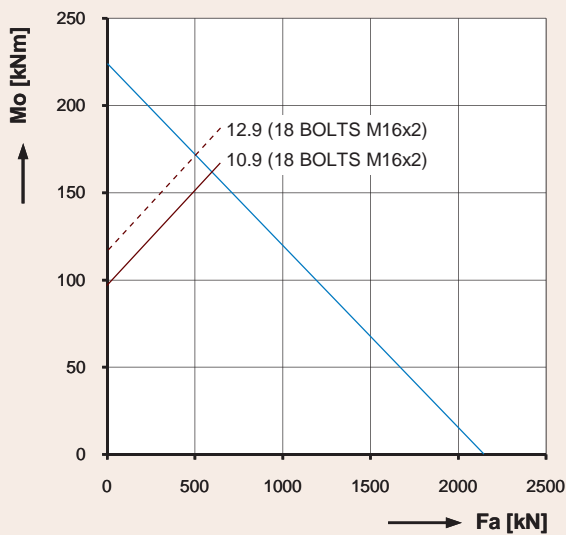

9O-1B30-0490-0377

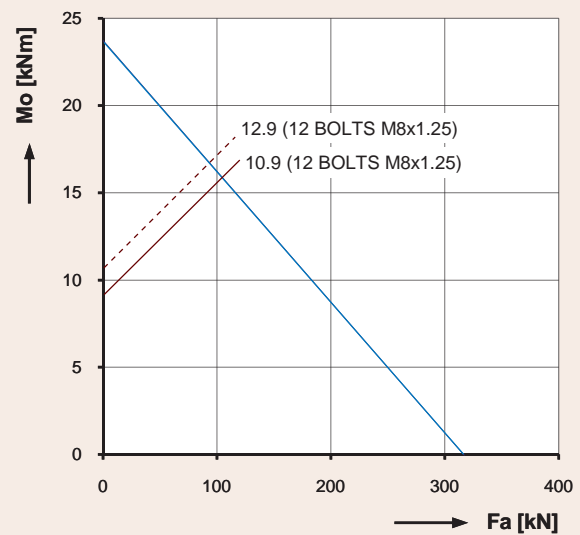

9O-1Z14-0300-0378

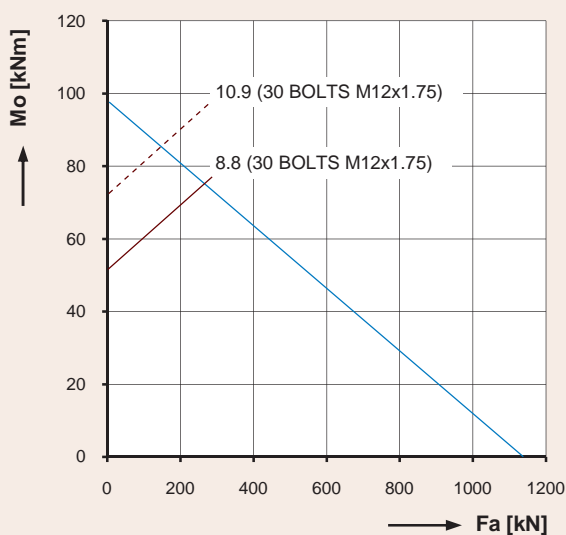

9O-1B20-0405-0387

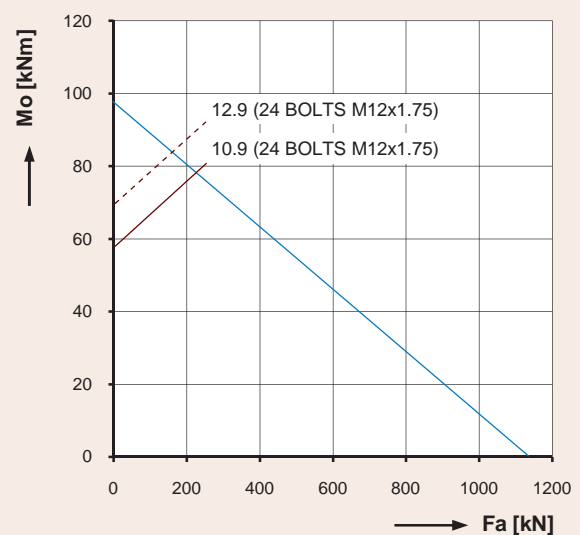

9O-1B20-0405-0387-1

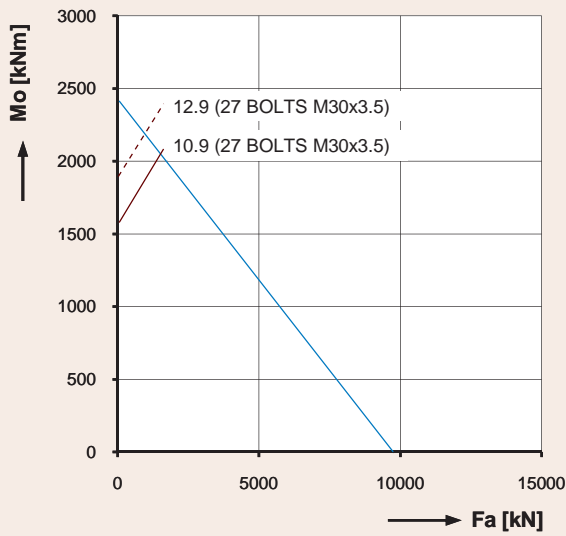

9E-1B57-1165-0388

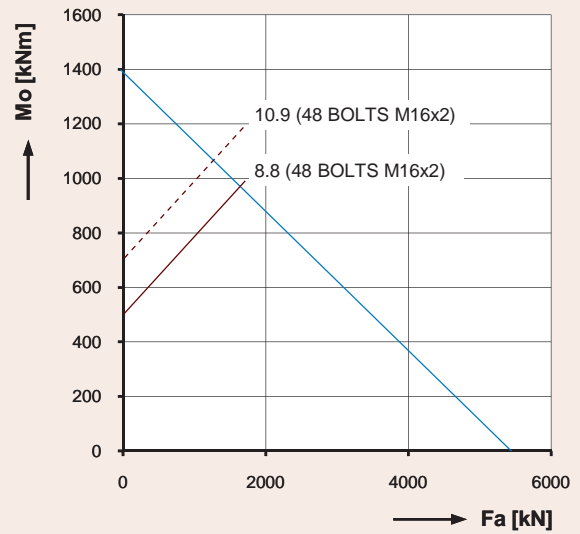

9I-1B32-1200-0392

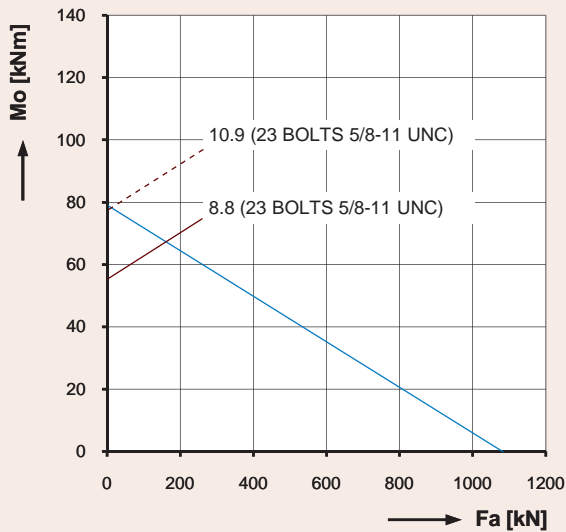

9E-1B22-0344-0396

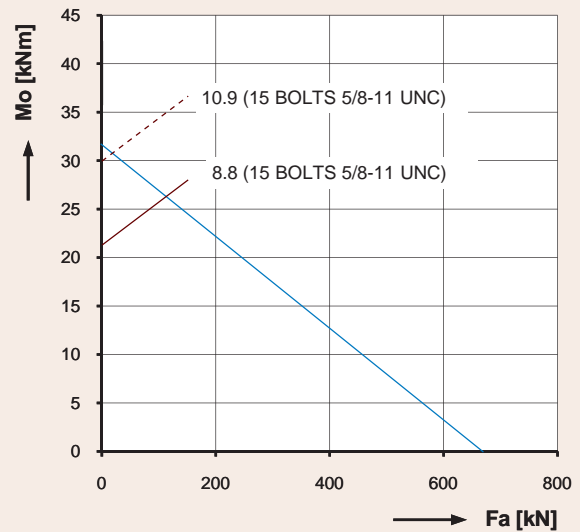

9O-1B22-0223-0397

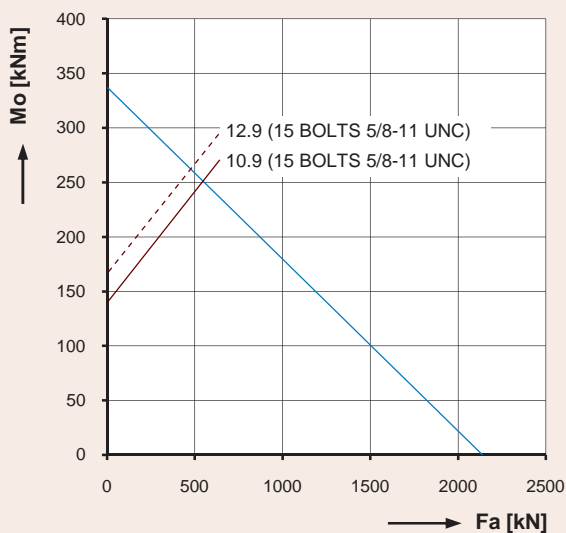

9I-1B20-0741-0400

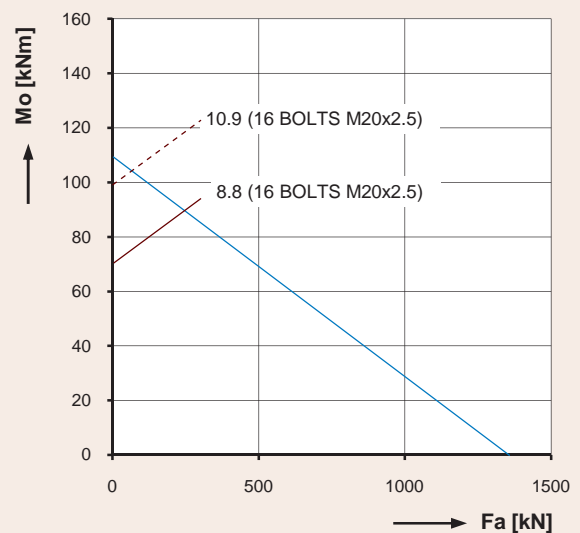

9O-1B25-0378-0401

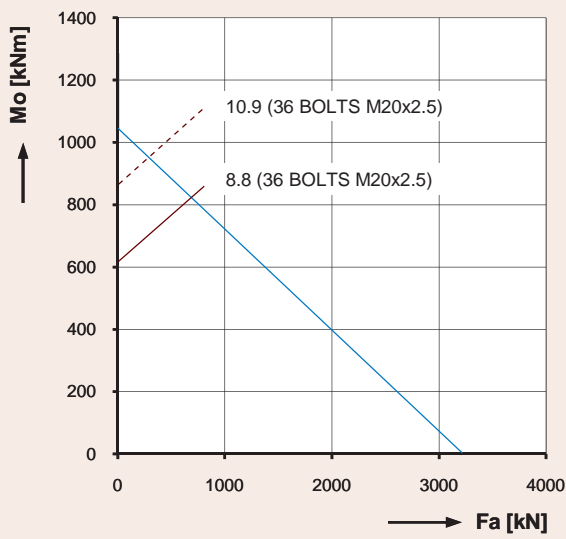

9I-1Z30-1305-0406

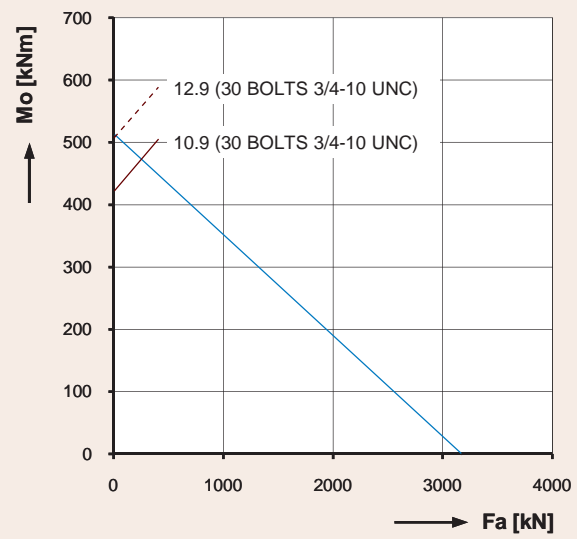

9I-1B29-0761-0411

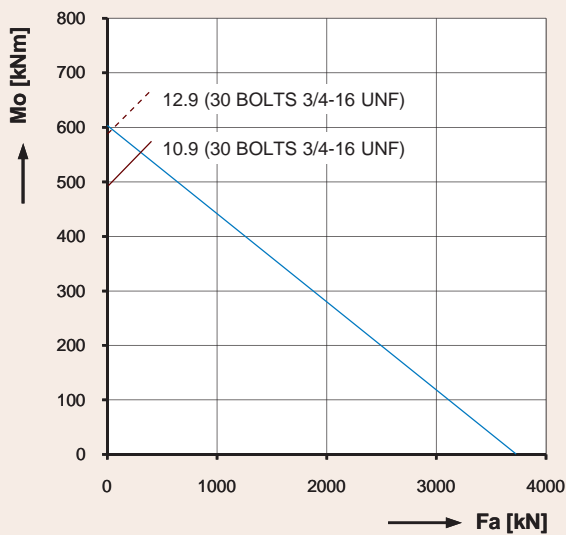

9I-1B35-0761-0414

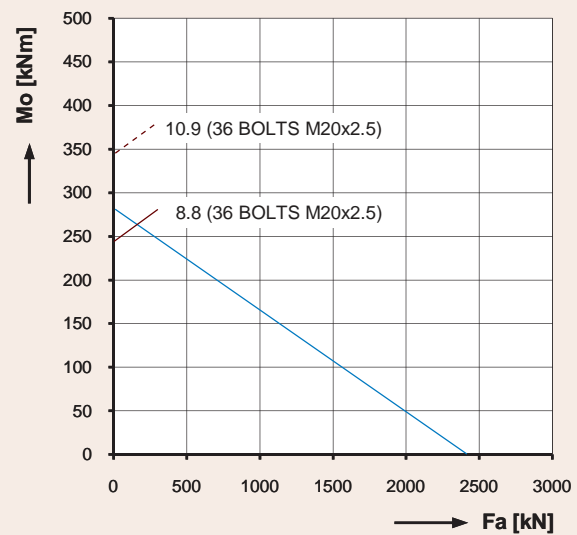

9O-1B32-0550-0418

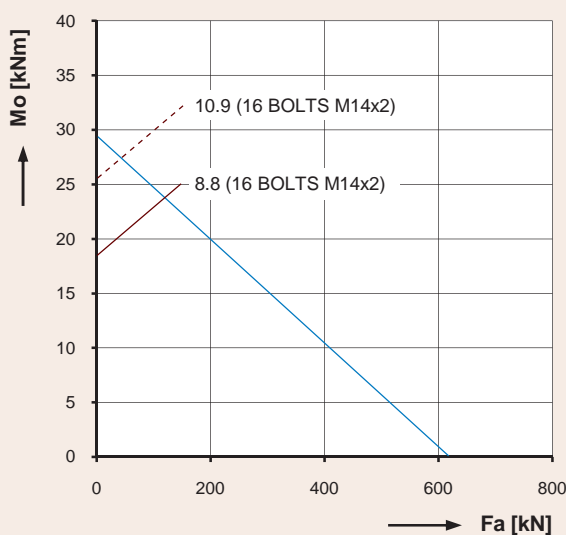

9O-1B20-0223-0427

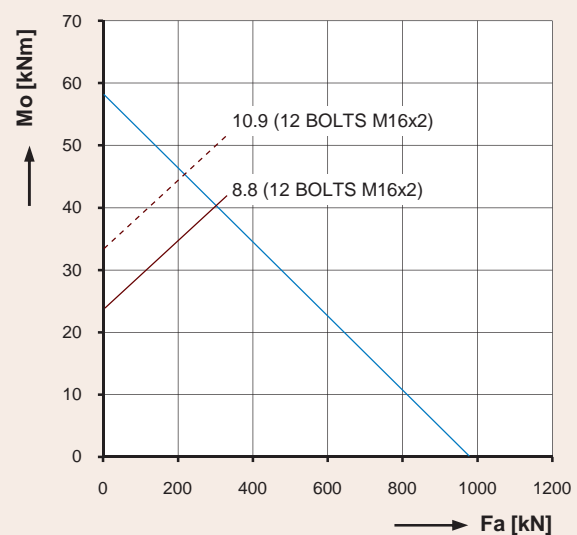

9O-1B25-0279-0428

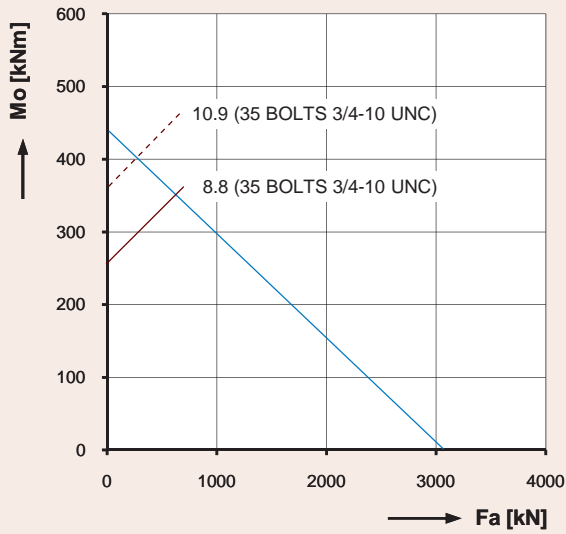

9E-1B32-0678-0430

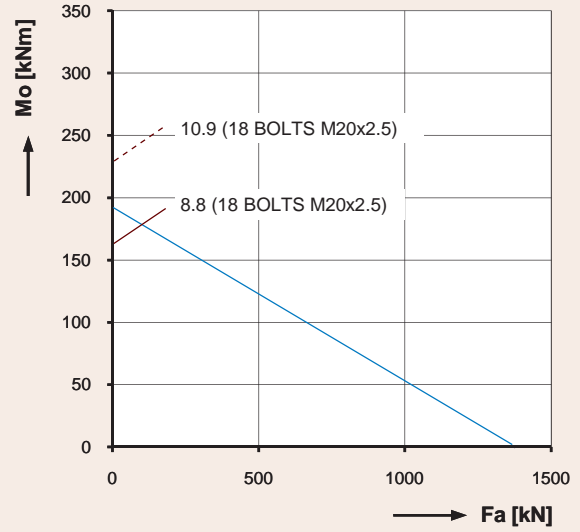

9O-1Z30-0561-0432-1

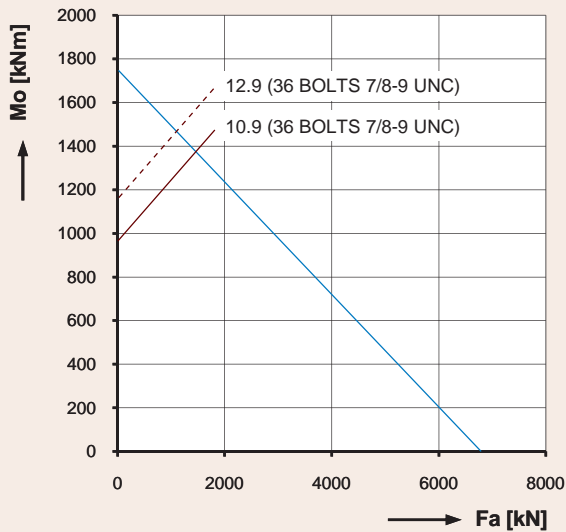

9E-1B40-1213-0433

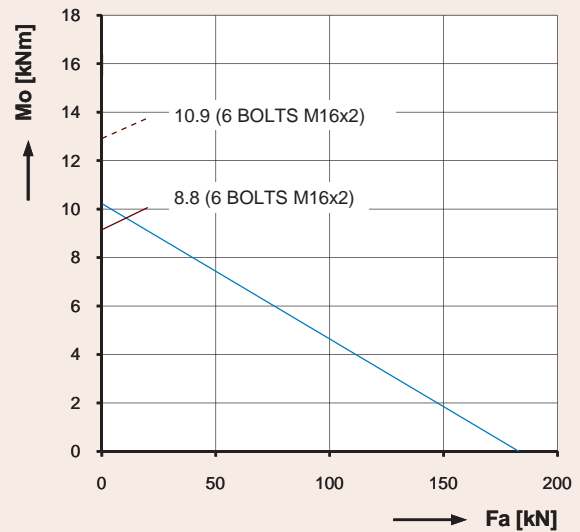

9O-1Z12-0222-0440-4

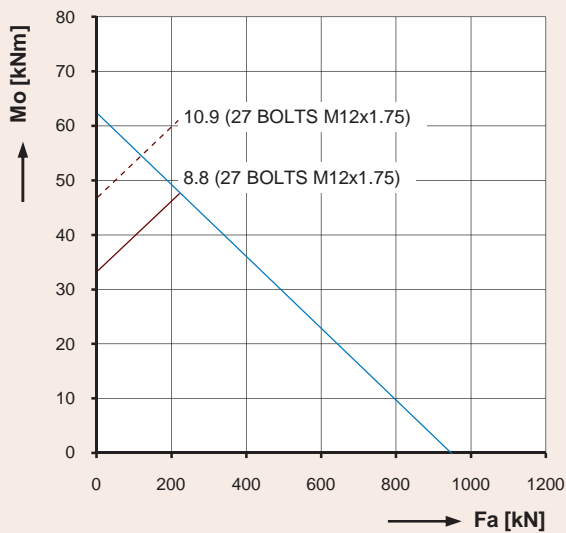

9E-1B22-0308-0443

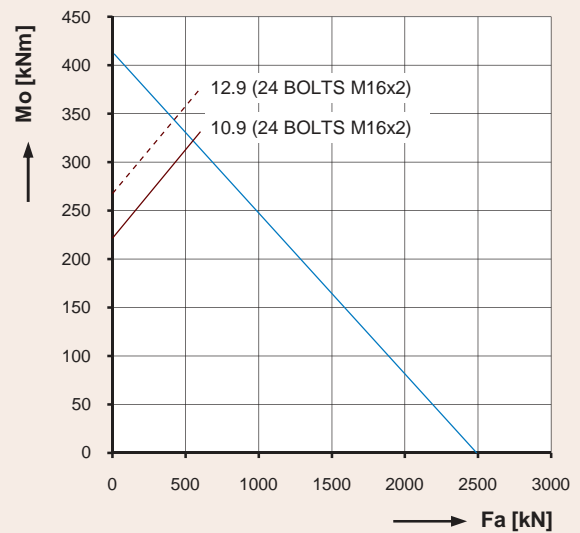

9I-1B22-0782-0444

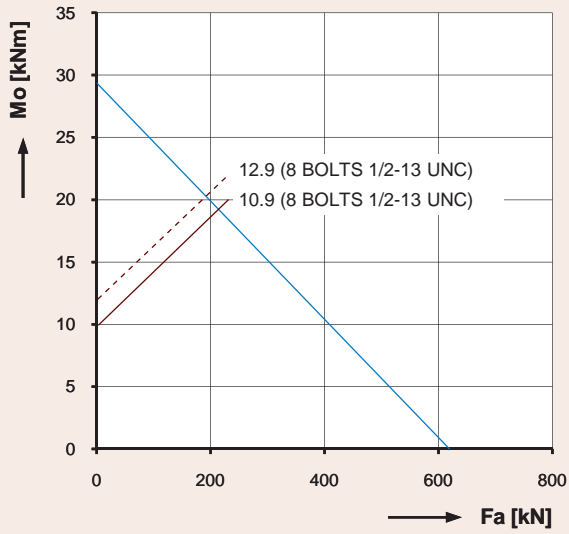

9O-1B20-0223-0447

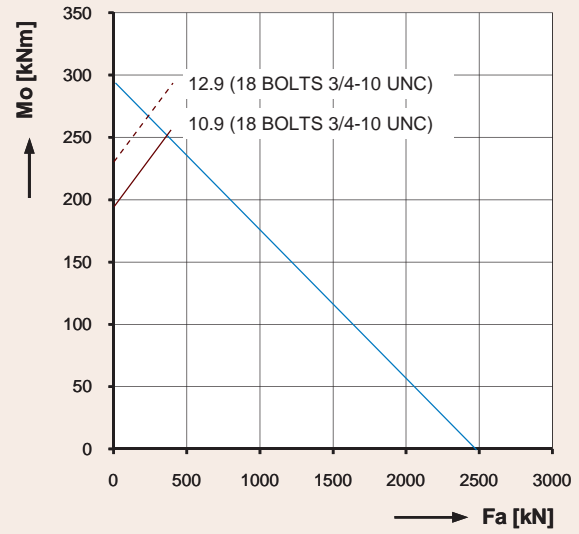

9I-1B32-0560-0449

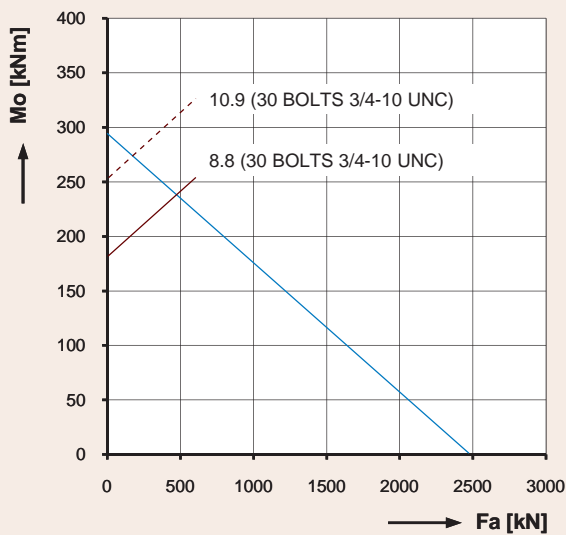

9I-1B32-0560-0449-1

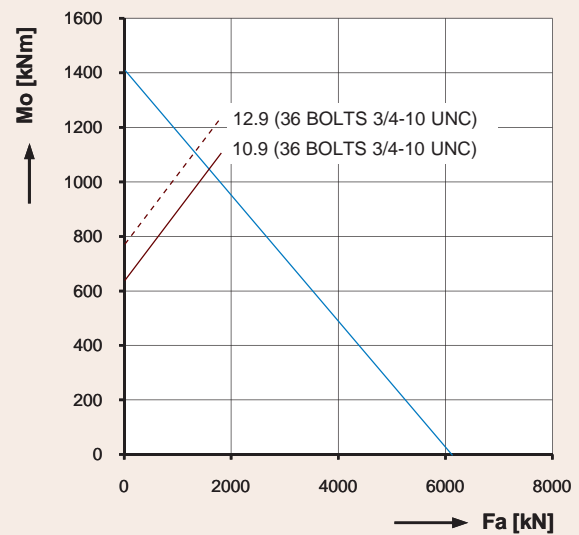

9I-1B40-1086-0450

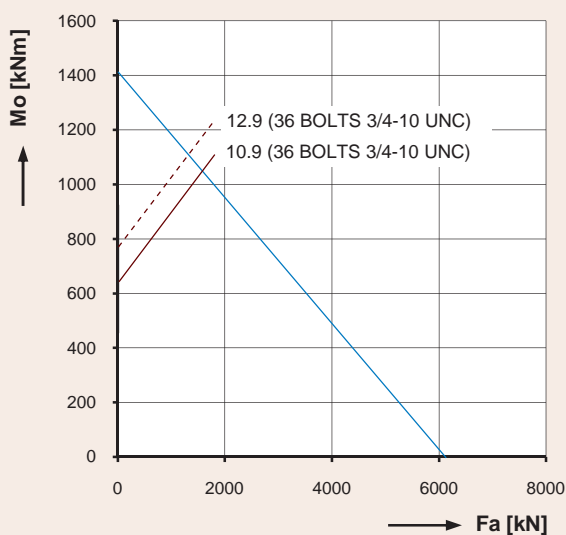

9I-1B40-1086-0450-1

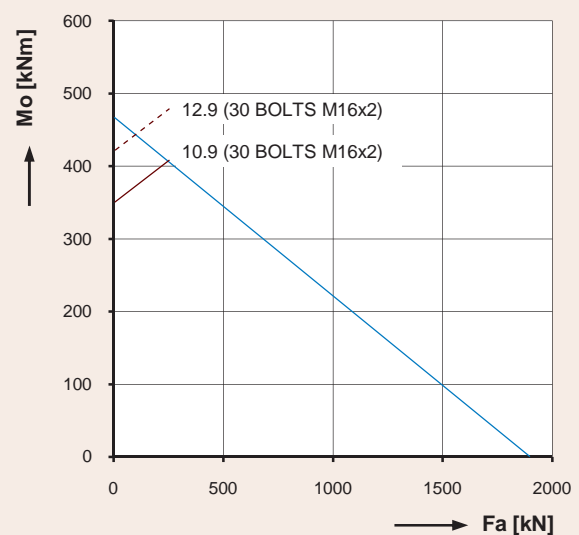

9E-1Z25-0984-0452

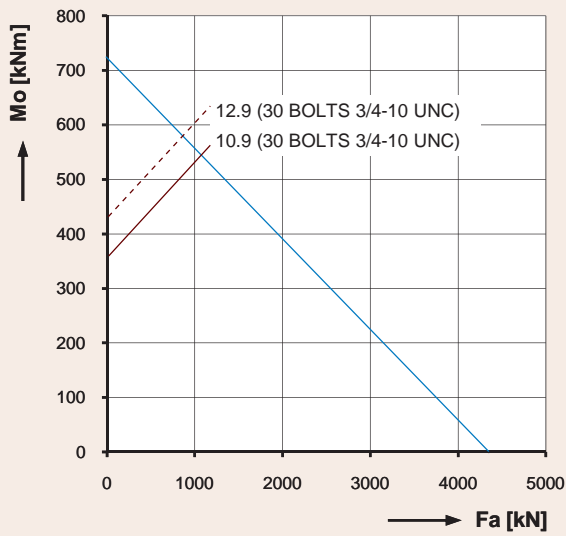

9I-1B40-0780-0454

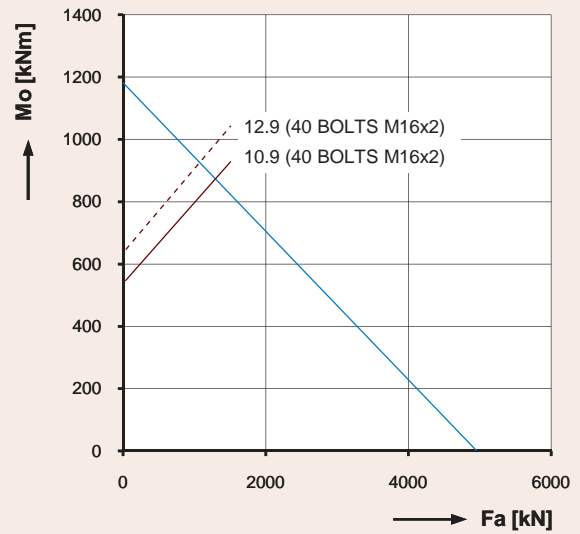

9E-1B30-1122-0455

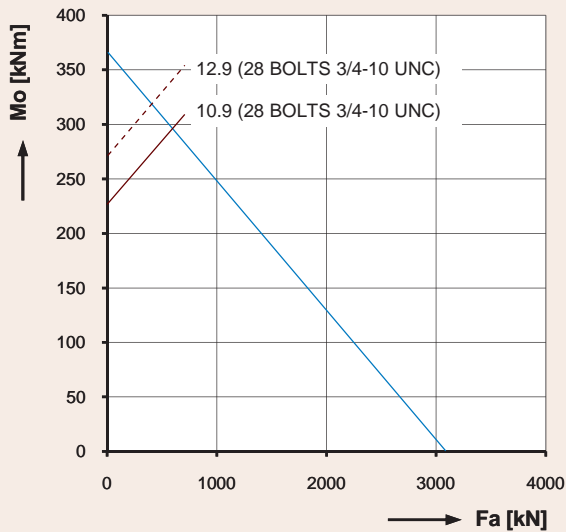

9E-1B40-0559-0457

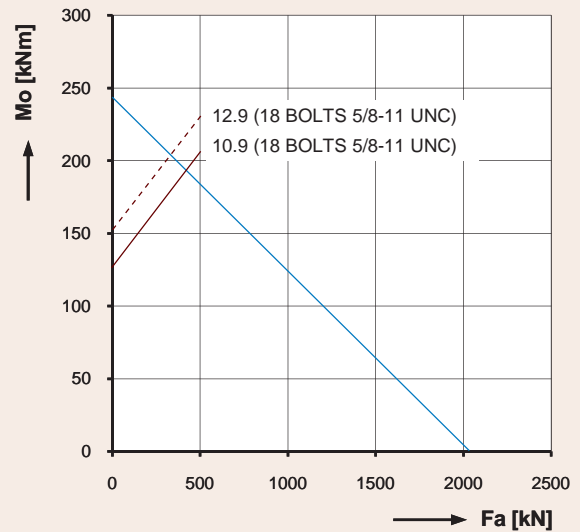

9I-1B25-0560-0467

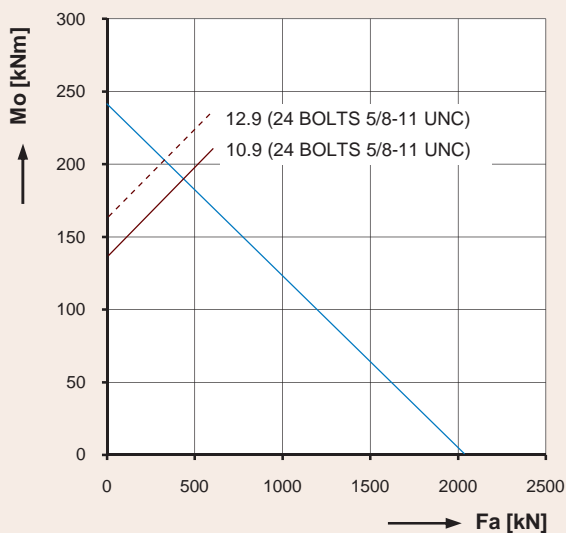

9I-1B25-0560-0467-1

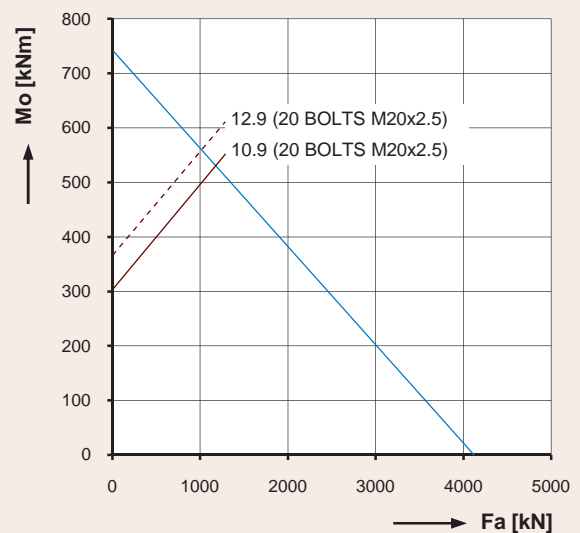

9O-1B35-0845-0476



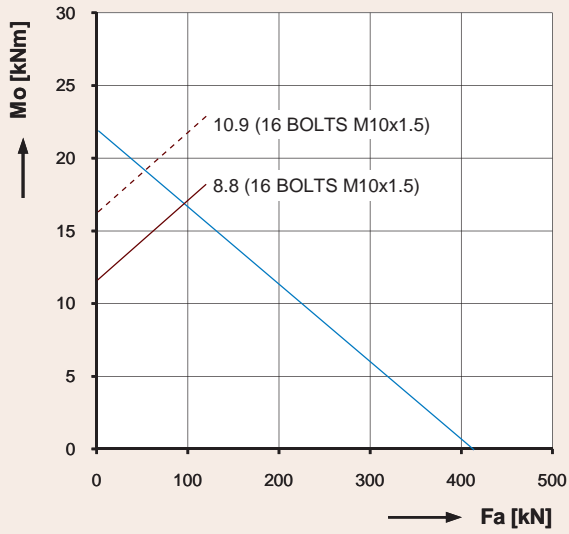

90-1B14-0250-0479

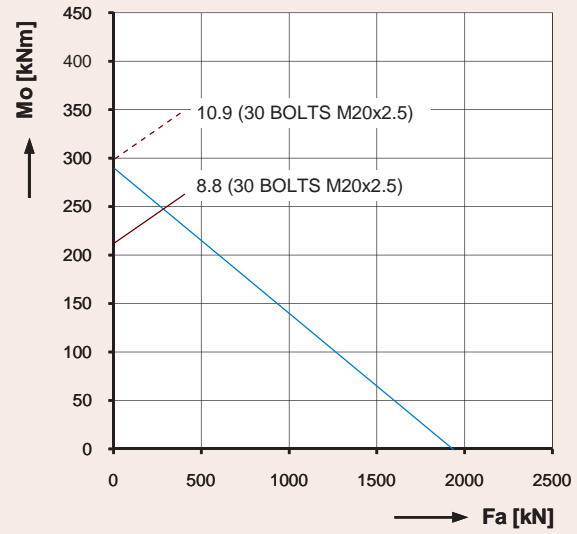

90-1Z40-0595-0480

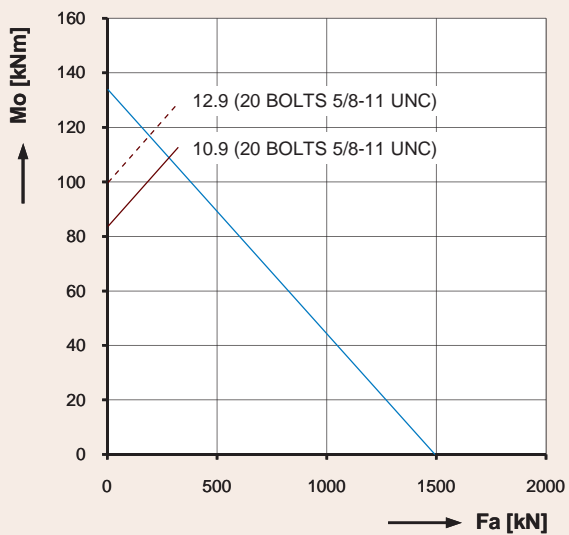

90-1B25-0422-0485

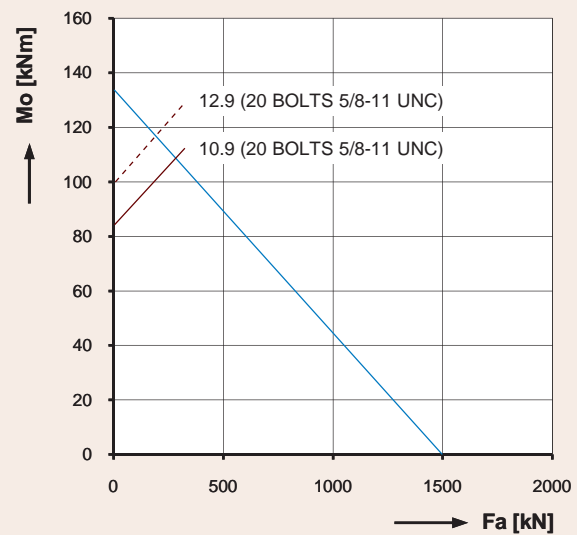

90-1B25-0422-0485-1

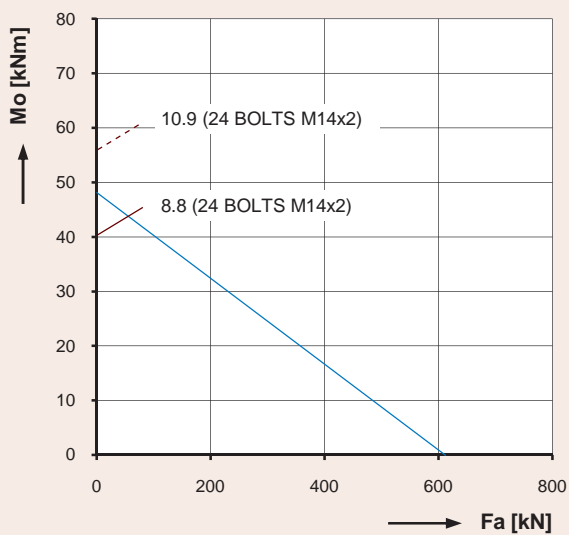

90-1Z25-0315-0487

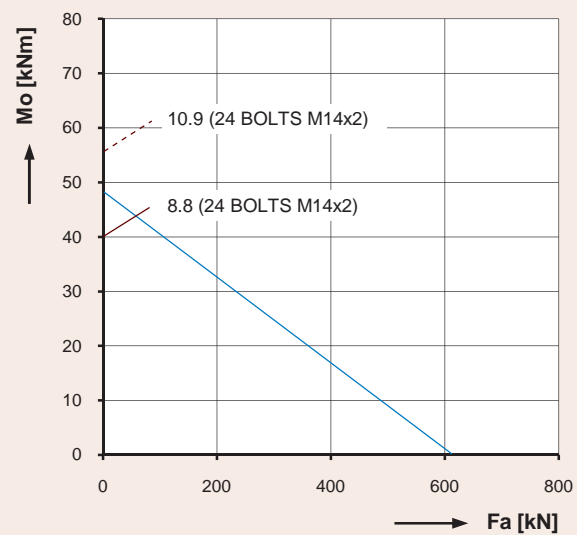

90-1Z25-0315-0487-1

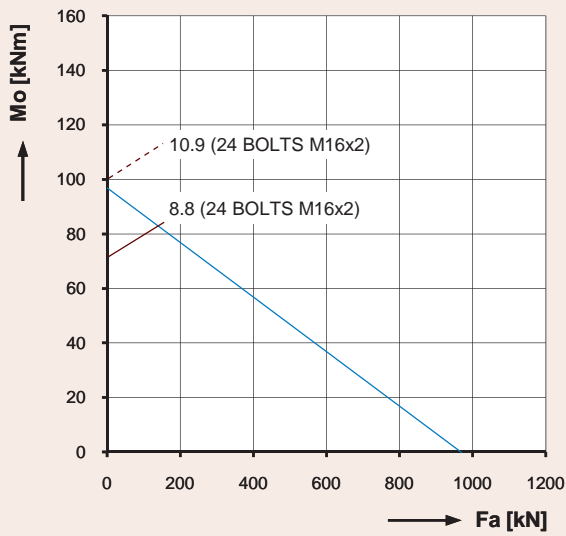

9O-1Z30-0400-0488

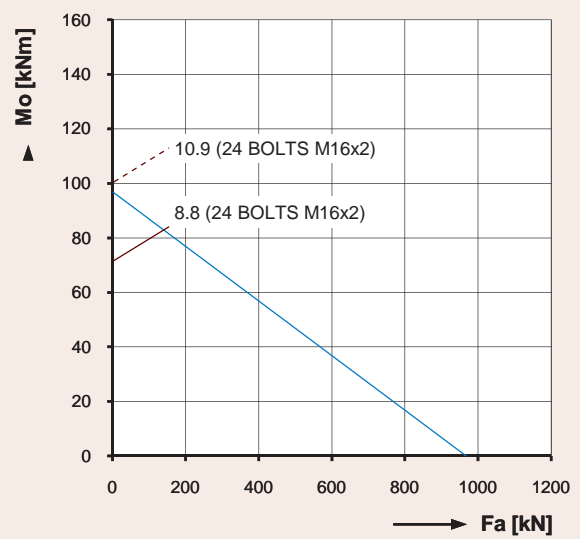

9O-1Z30-0400-0488-1

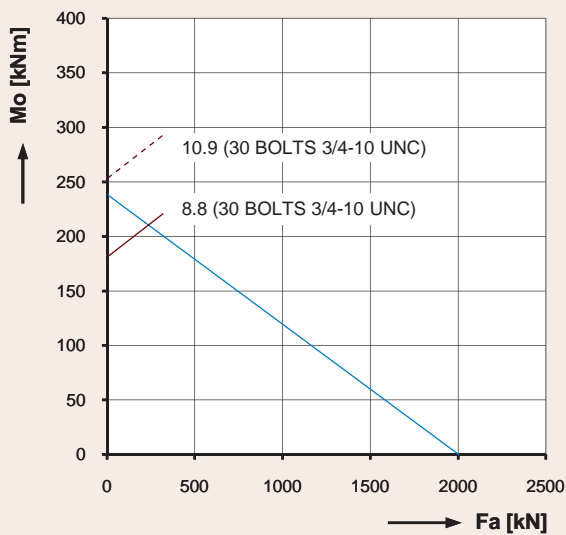

9I-1B25-0559-0496

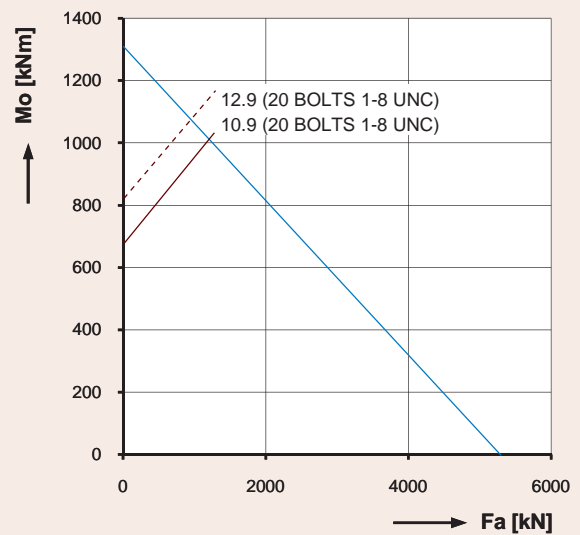

9I-1B32-1167-0504

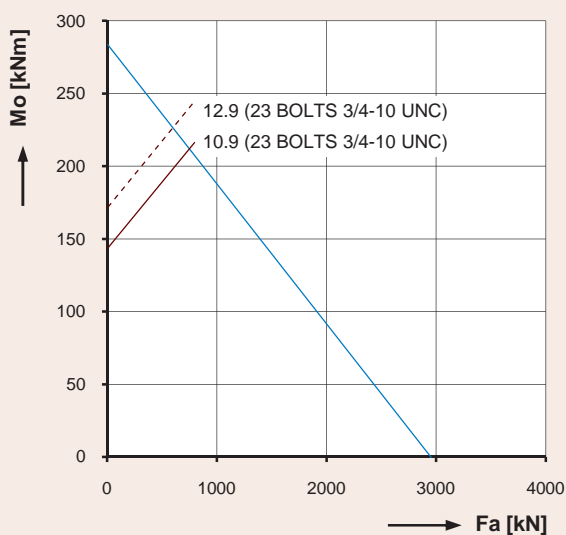

9E-1B45-0452-0509

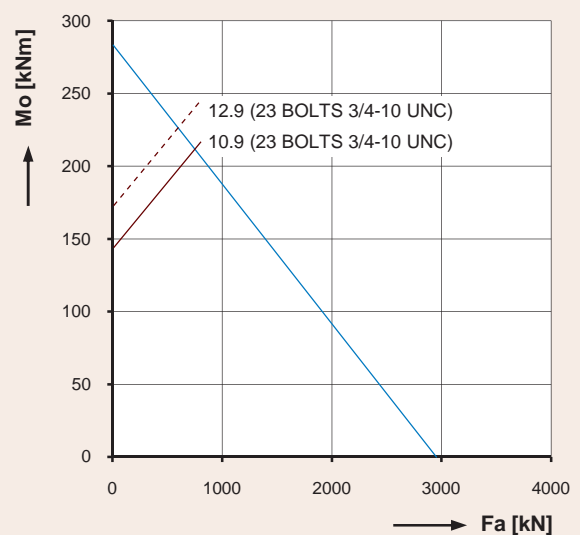

9E-1B45-0452-0509-1

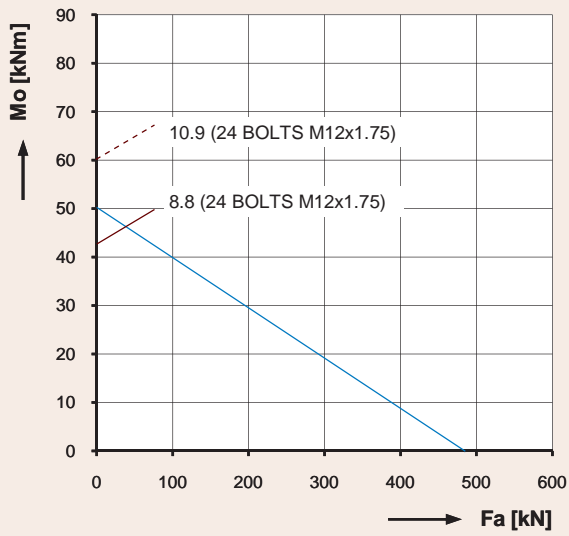

9I-1Z16-0415-0510

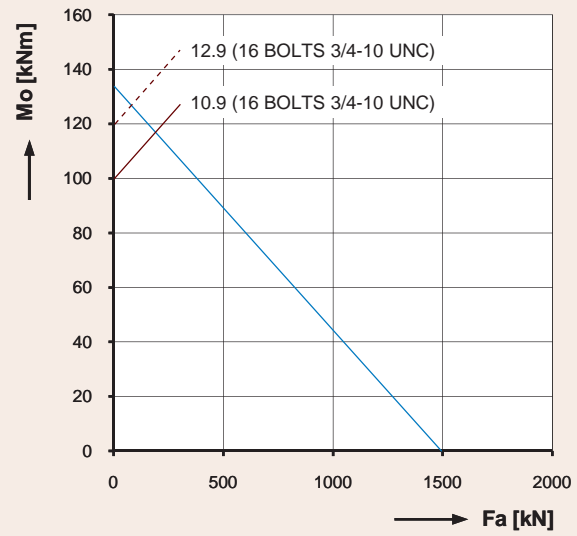

9O-1B25-0422-0513-1

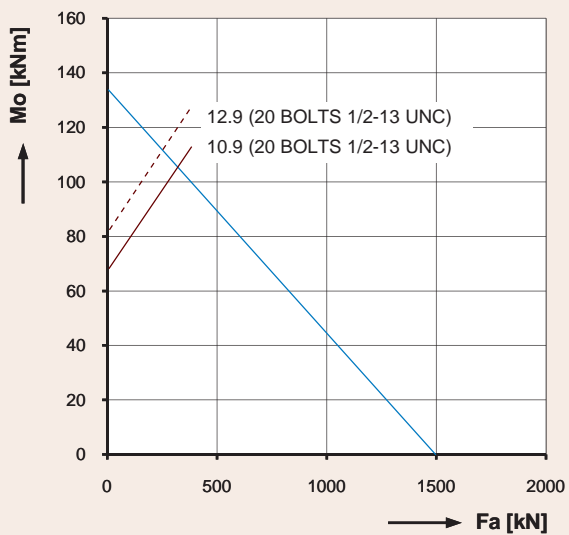

9O-1B25-0422-0513-2

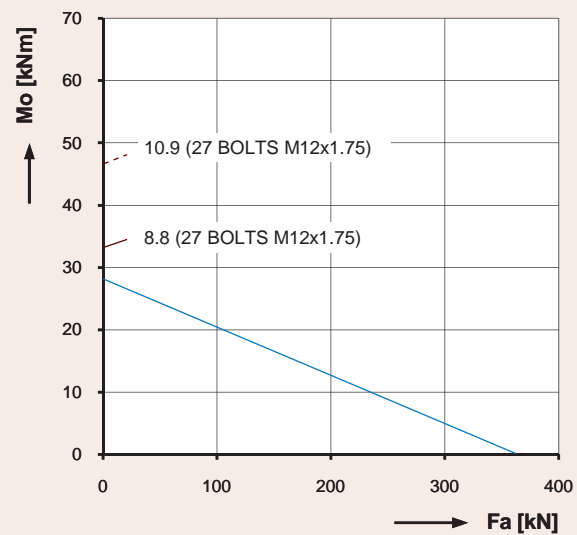

9E-1Z16-0310-0517

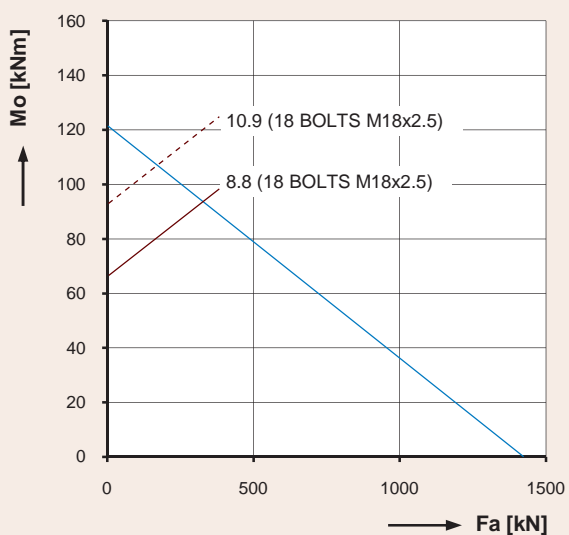

9E-1B25-0401-0519

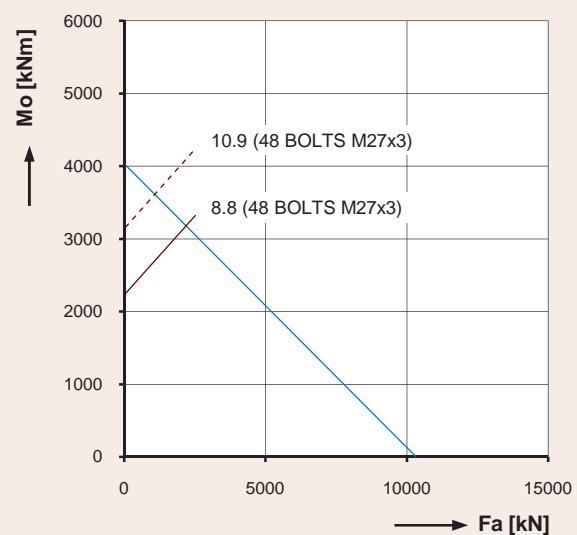

9E-1B40-1830-0521

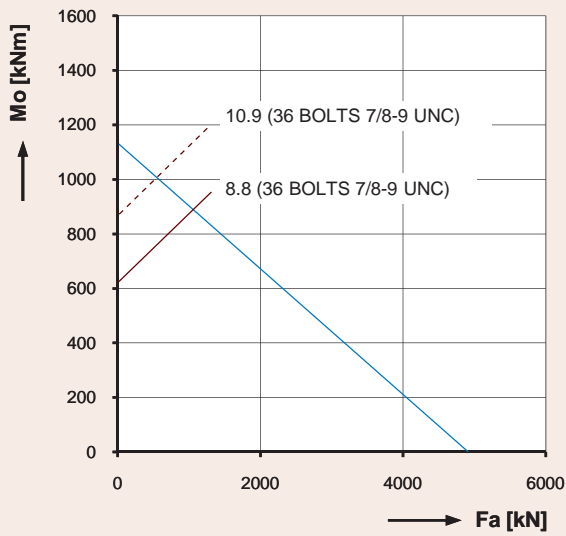

9E-1B32-1086-0530

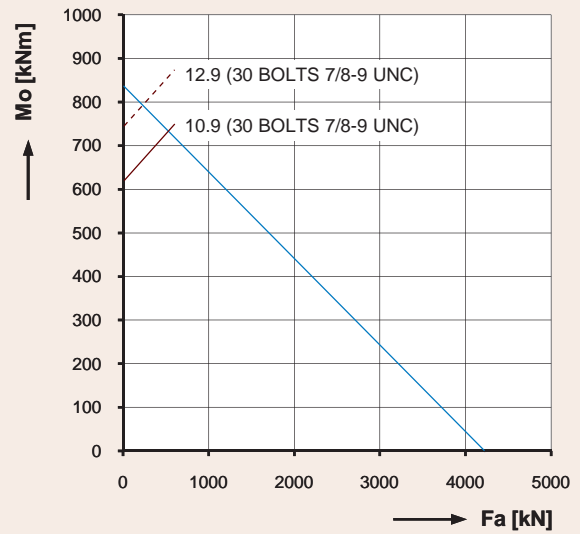

9E-1B32-0933-0531

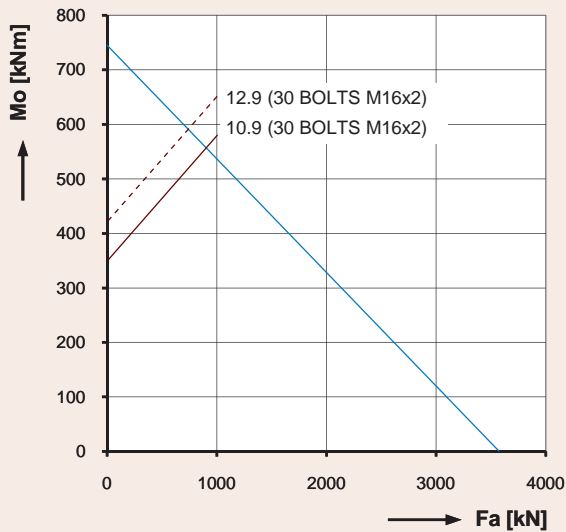

9E-1B25-0978-0533

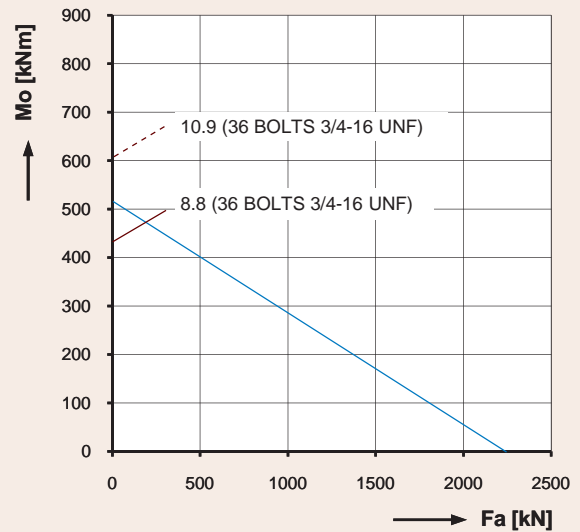

9I-1Z30-0923-0534

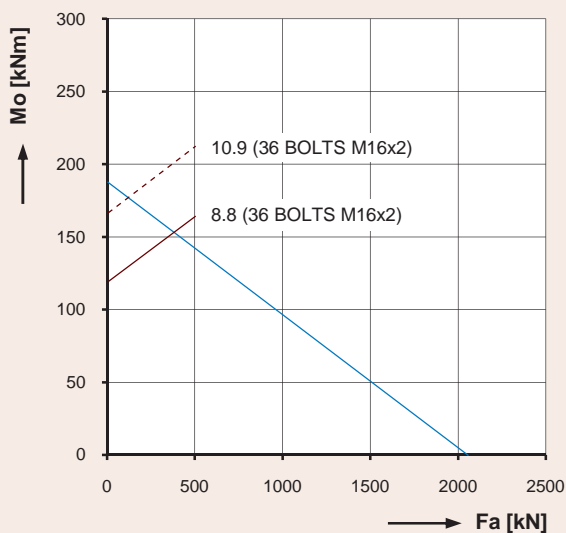

9O-1B35-0430-0537

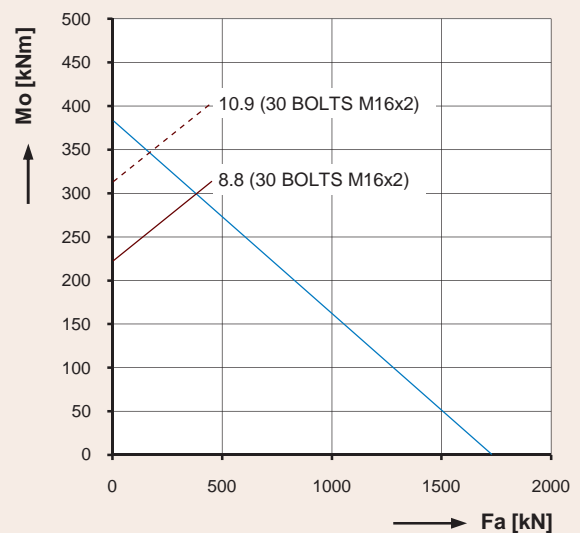

9I-1Z25-0886-0538

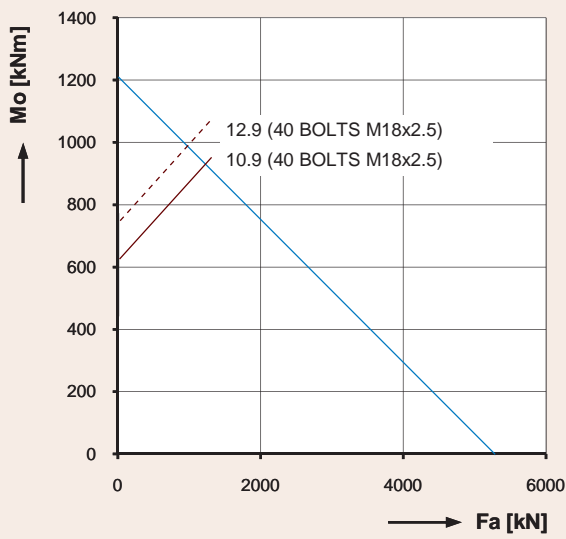

9E-1B35-1077-0542-1

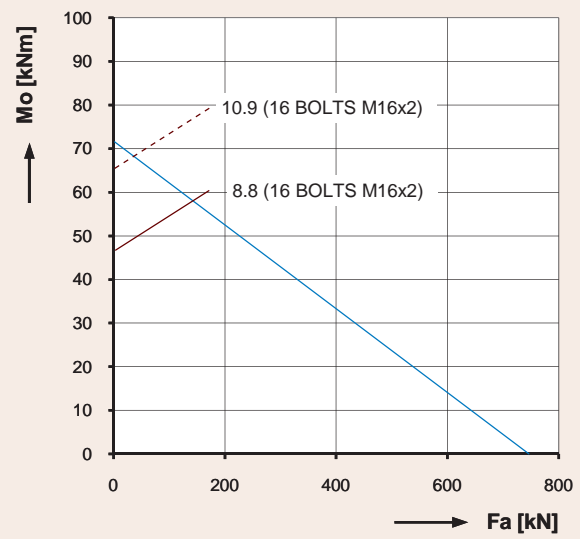

9O-1Z25-0384-0544

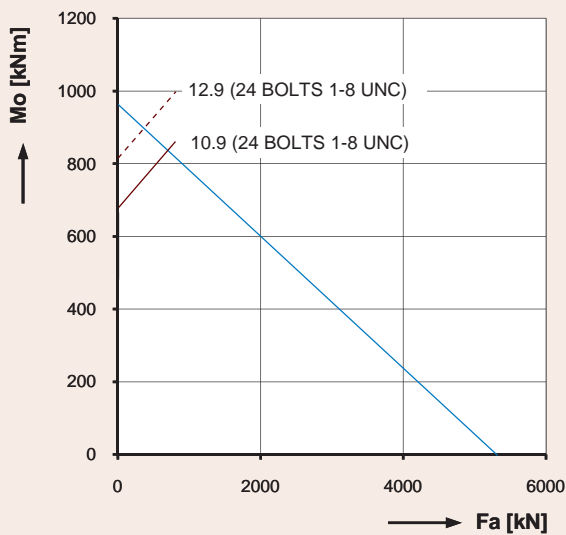

9E-1B45-0854-0545

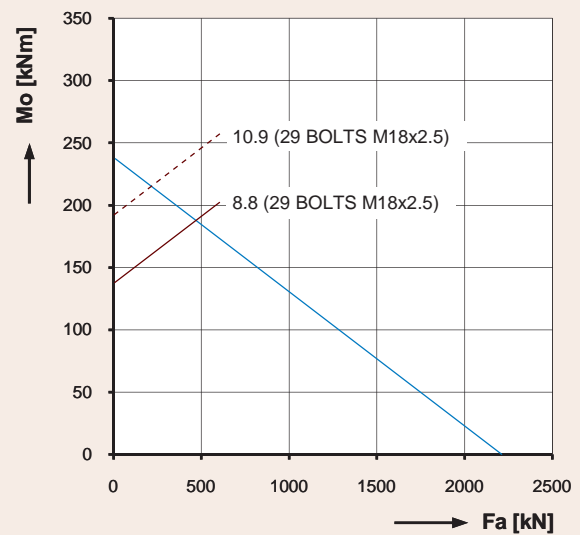

9E-1B30-0507-0548

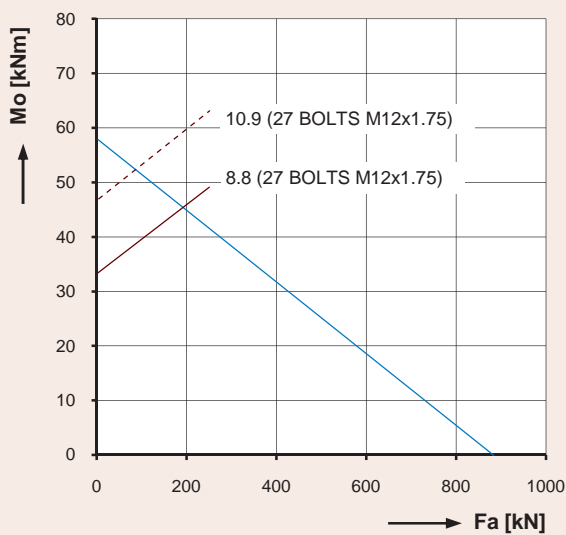

9E-1B20-0309-0549

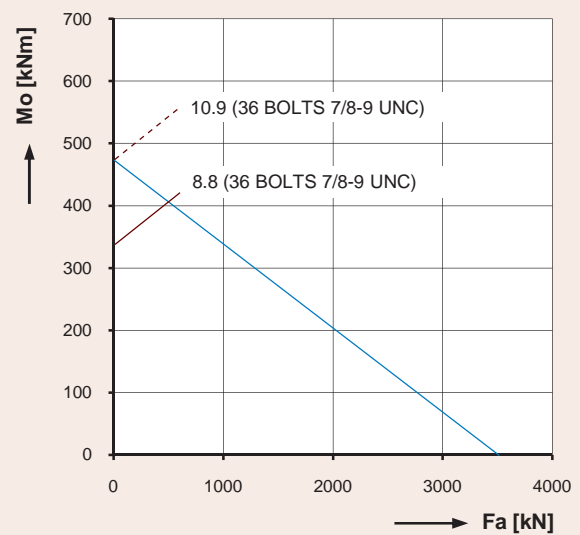

9O-1B40-0635-0550

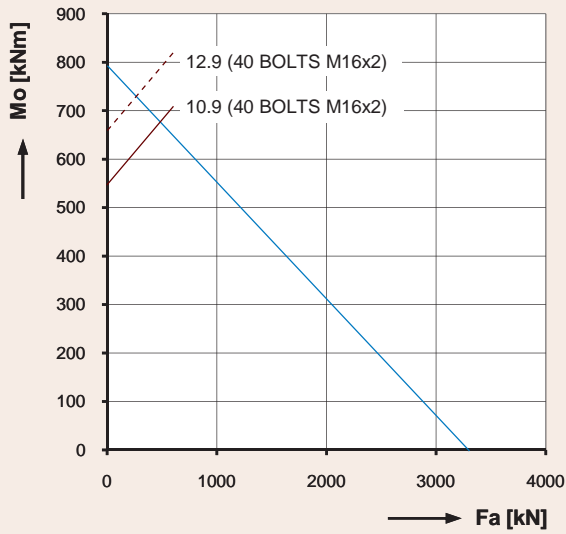

9I-1B20-1131-0552

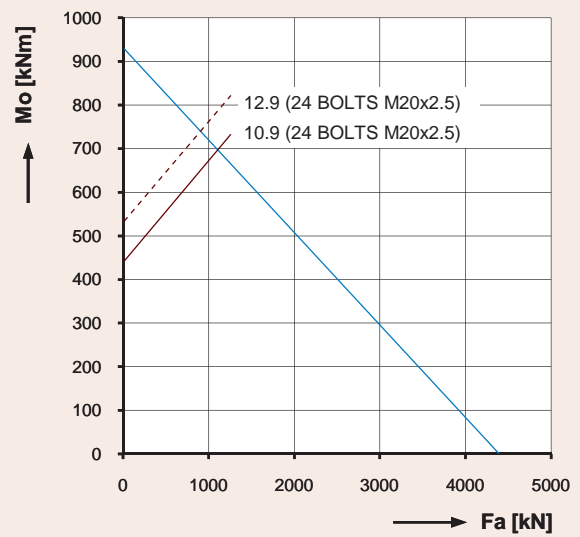

9I-1B30-0995-0558

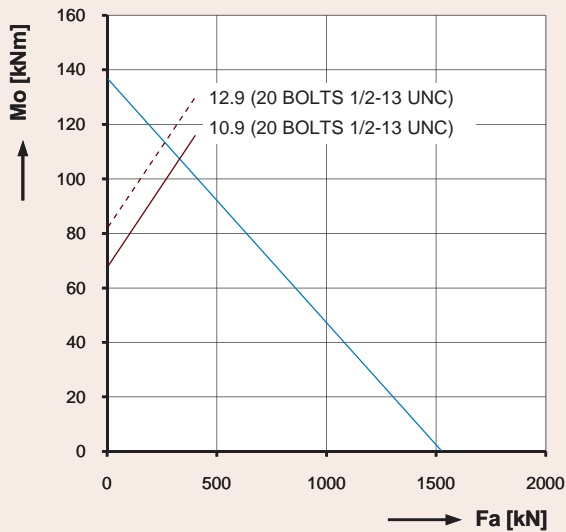

9O-1B25-0422-0564

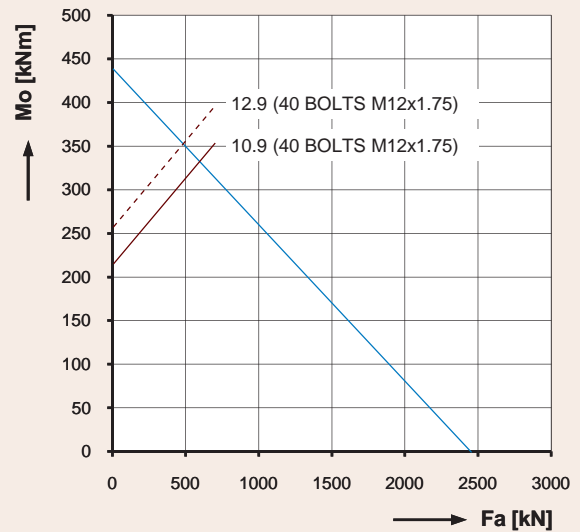

9O-1B20-0844-0565-1

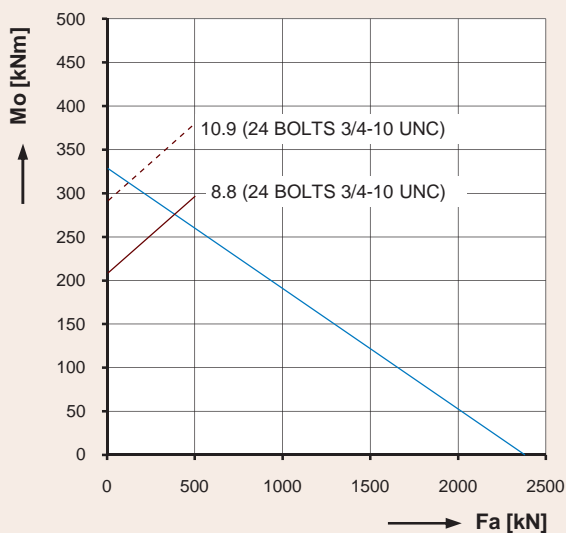

9I-1B25-0651-0569

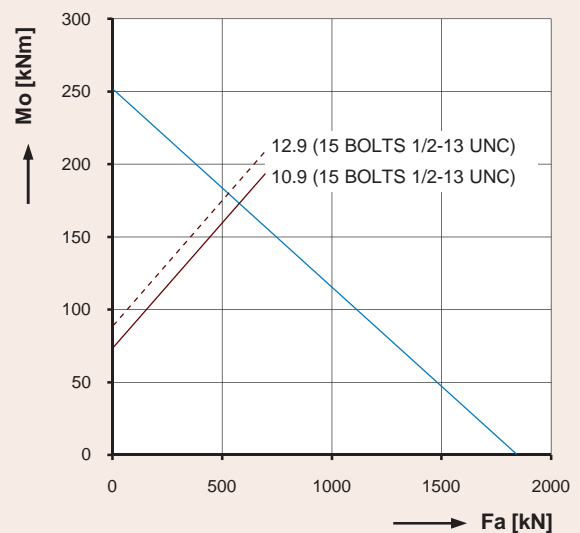

9E-1B20-0641-0571

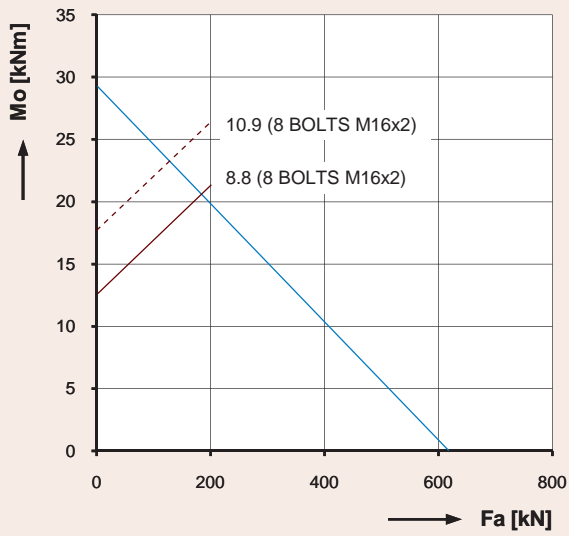

9O-1B20-0223-0574

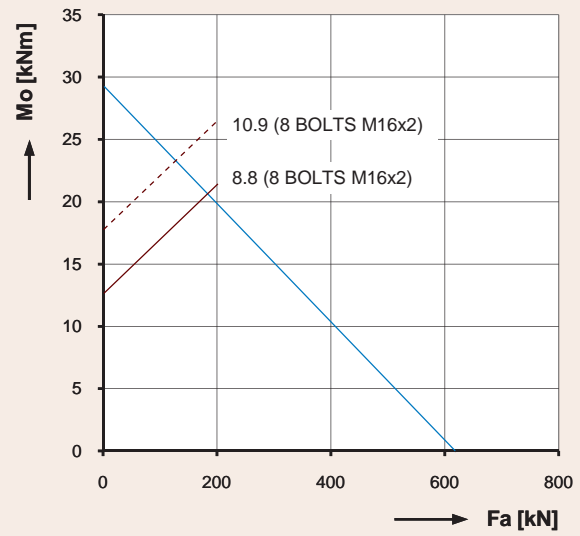

9O-1B20-0223-0574-1

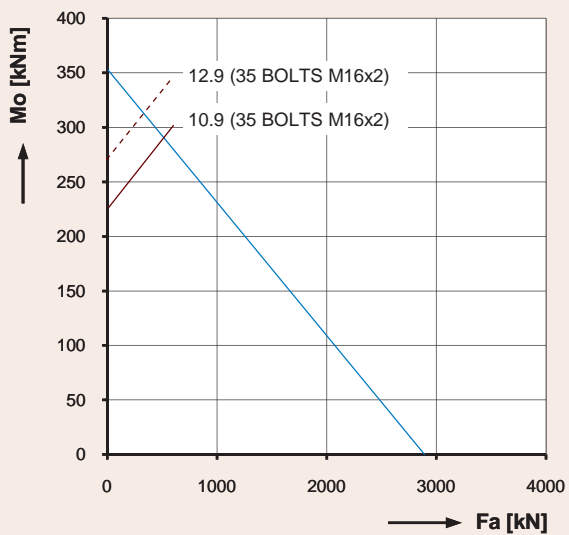

9E-1B32-0574-0576-1

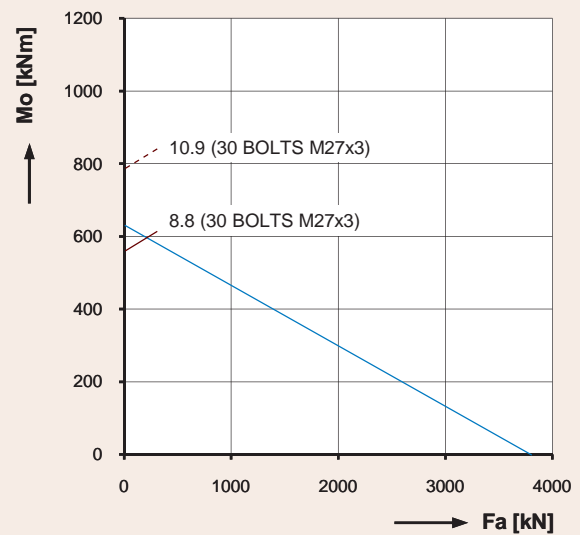

9I-1B35-0780-0577

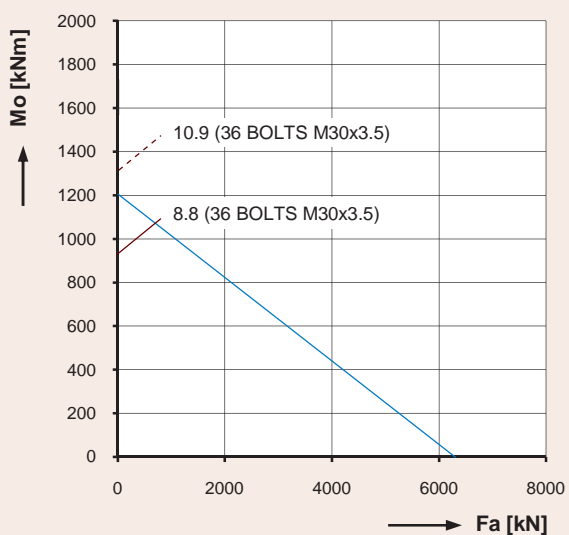

9O-1B50-0900-0579

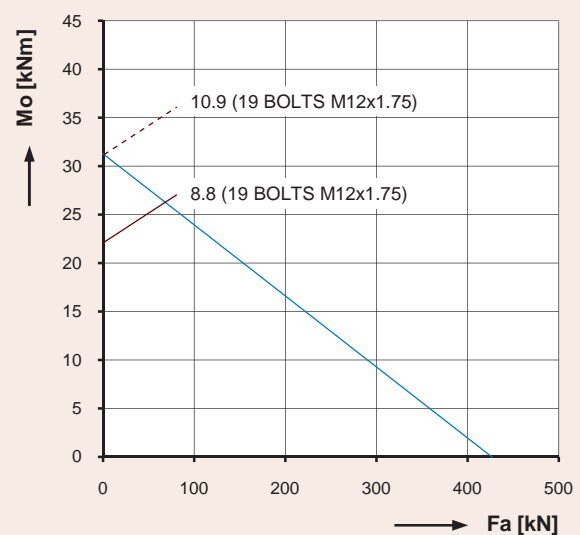

9O-1Z20-0295-0595

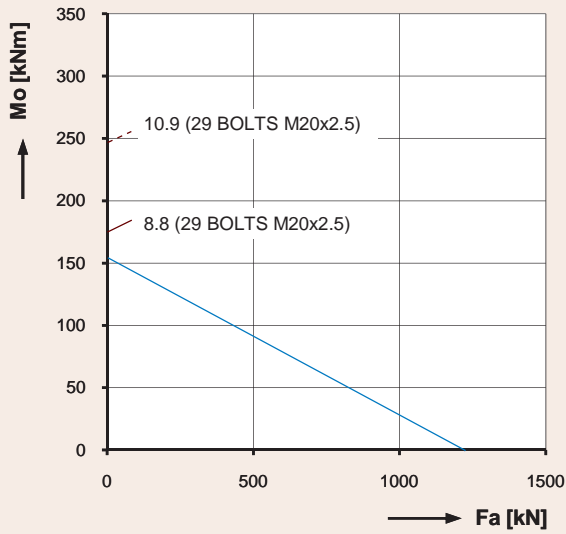

9E-1Z30-0505-0597

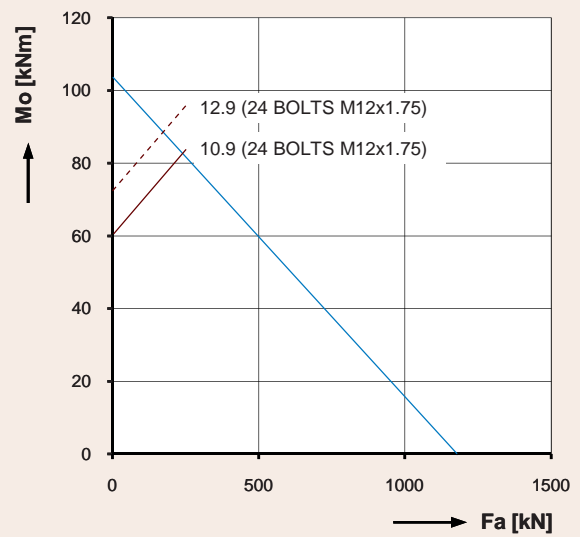

9I-1B20-0414-0599

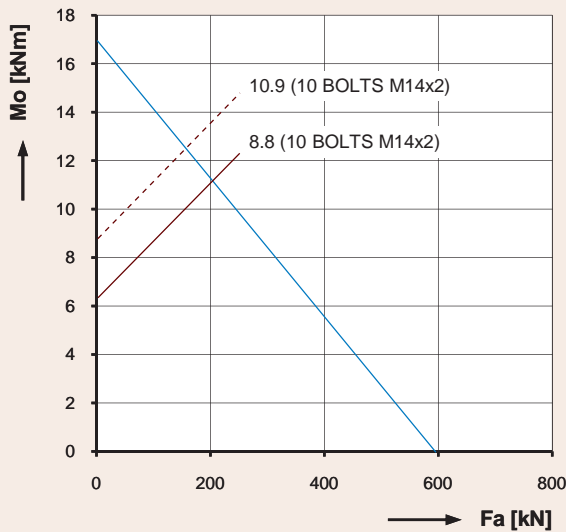

9O-2B16-0134-0605

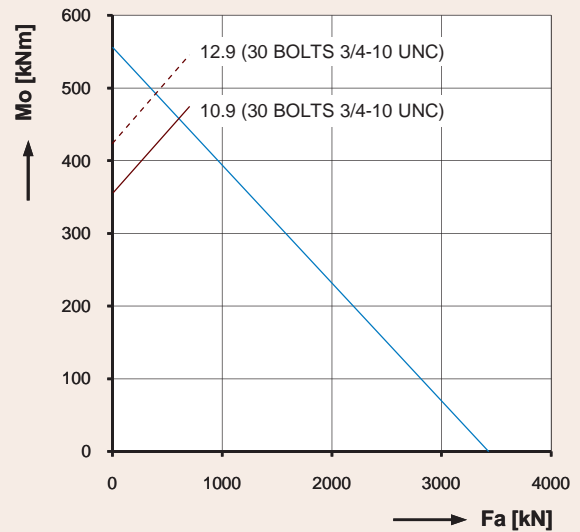

9E-1B32-0762-0609

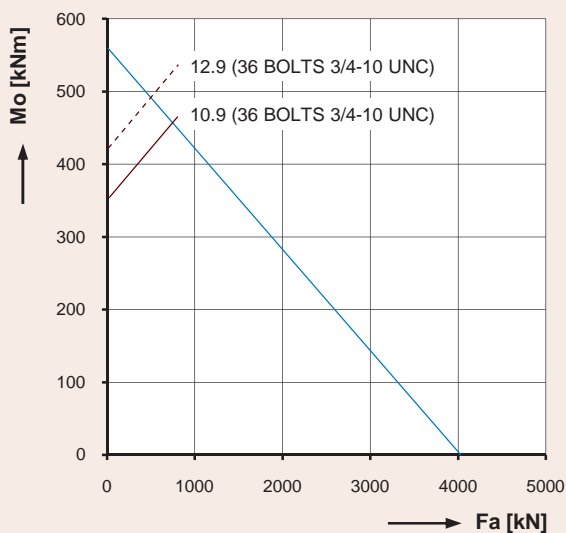

9O-1B45-0654-0614

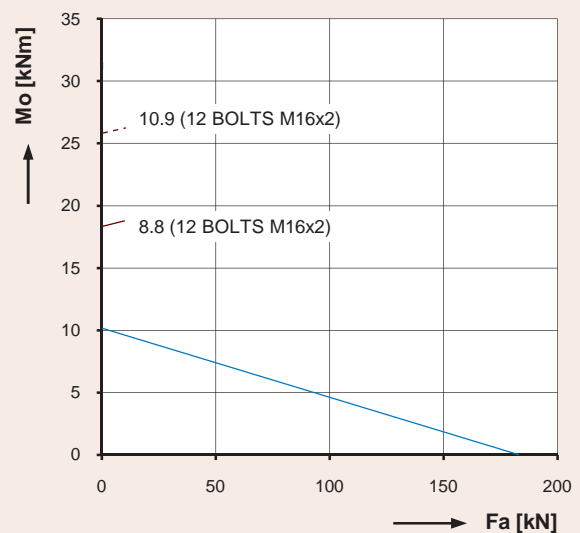

9O-1Z12-0222-0619



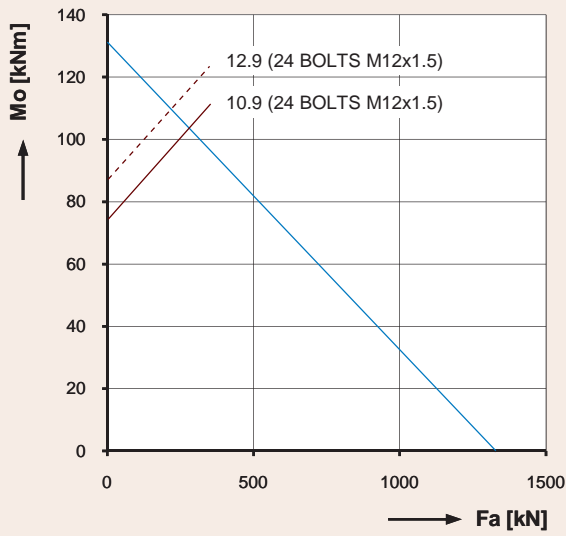

9I-1B20-0465-0622

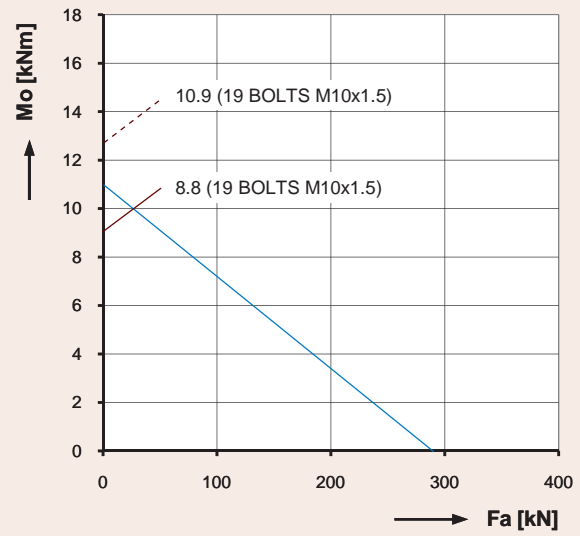

9E-1B14-0179-0624-1

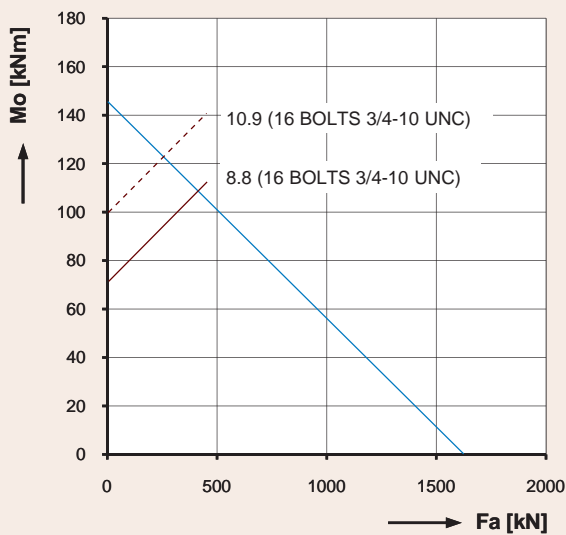

9E-1B25-0422-0627

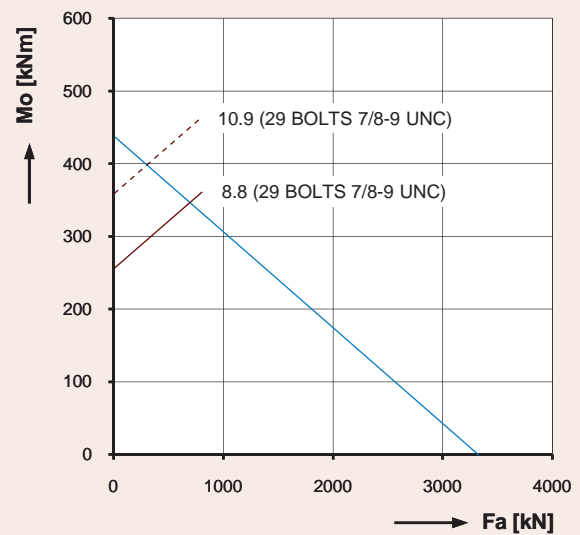

9E-1B40-0613-0632

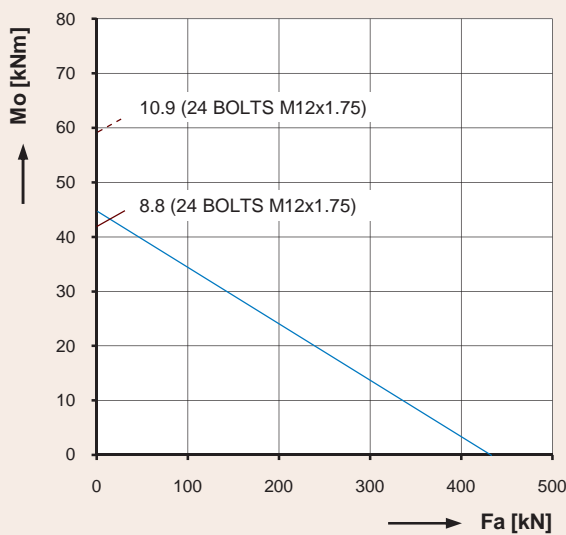

9E-1Z14-0414-0635

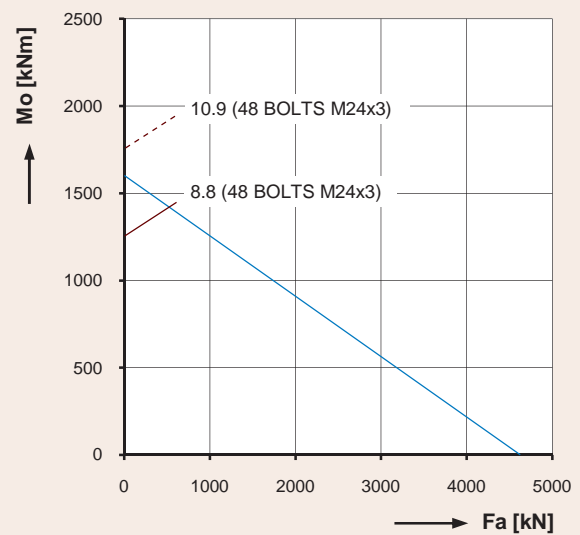

9I-1Z40-1385-0639

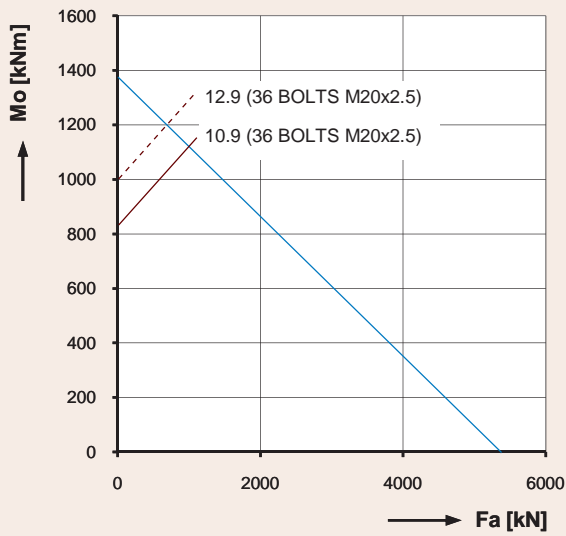

9I-1B30-1205-0644

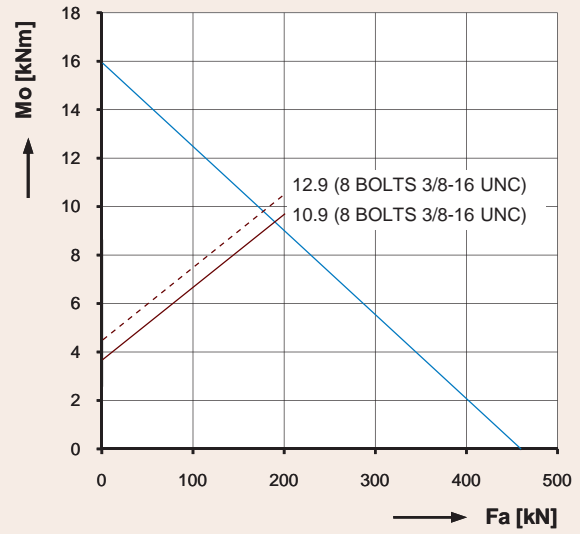

9O-1B20-0163-0650

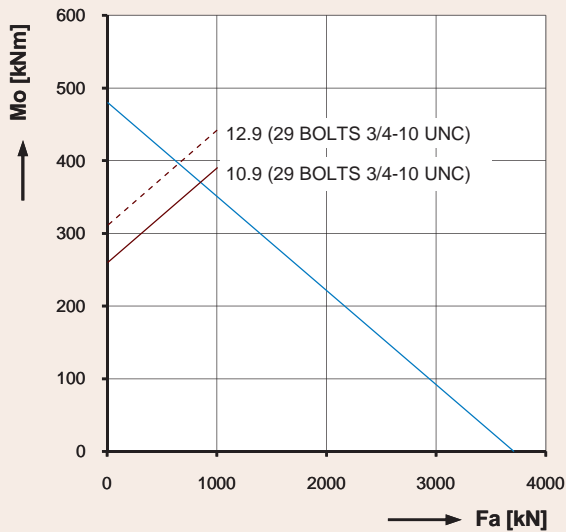

9E-1B45-0609-0651

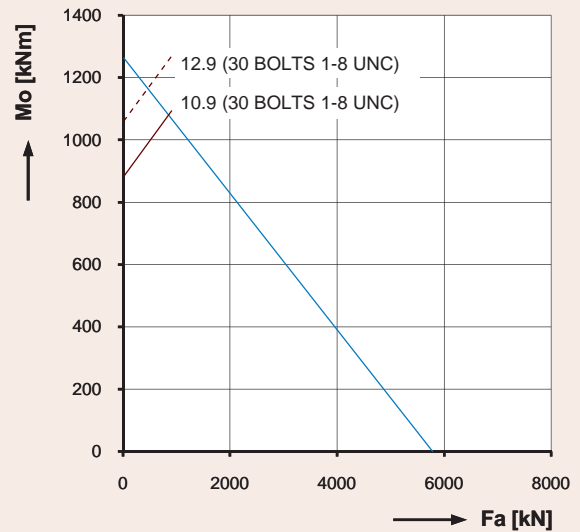

9E-1B40-1029-0652

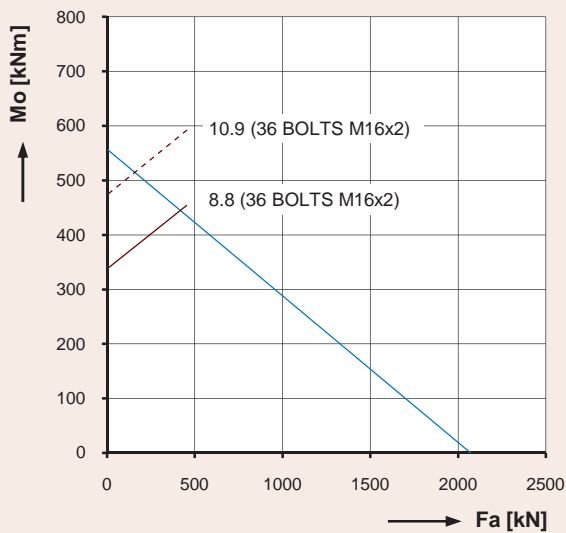

9I-1Z25-1075-0654

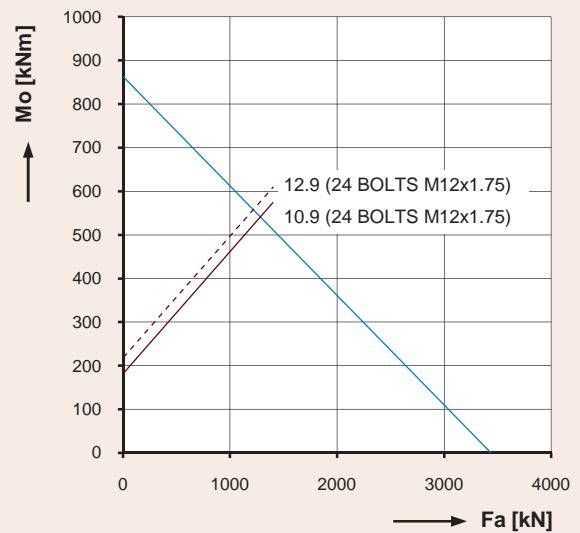

9O-1B20-1177-0655

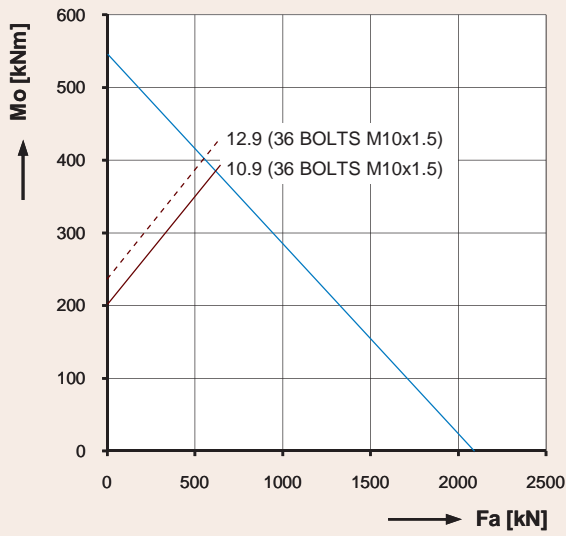

90-1B14-1229-0657

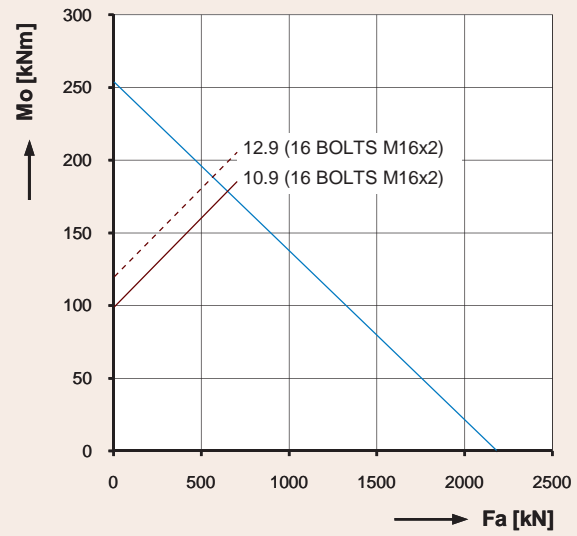

9I-1B25-0547-0660

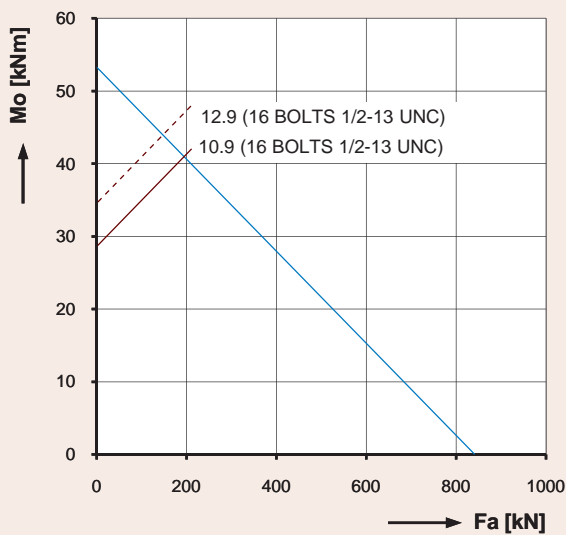

9I-1B20-0298-0661

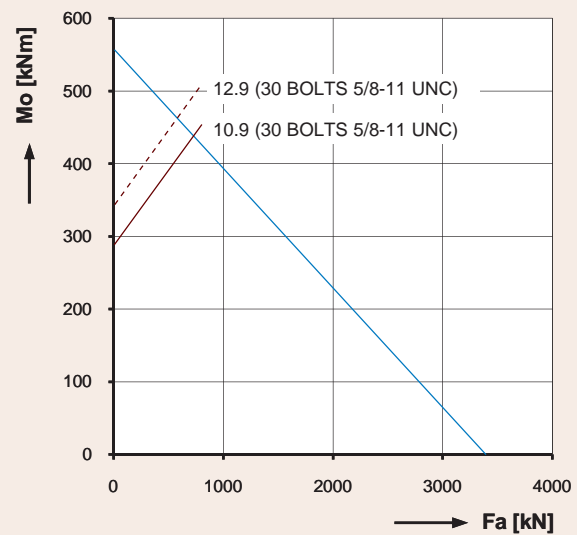

9E-1B30-0772-0664

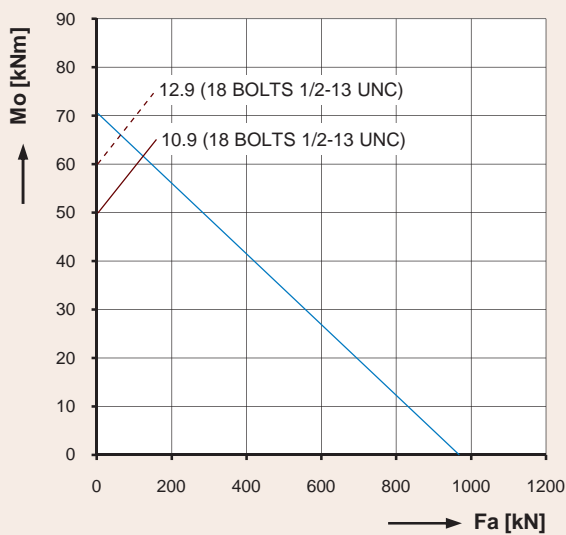

9E-1B20-0343-0667

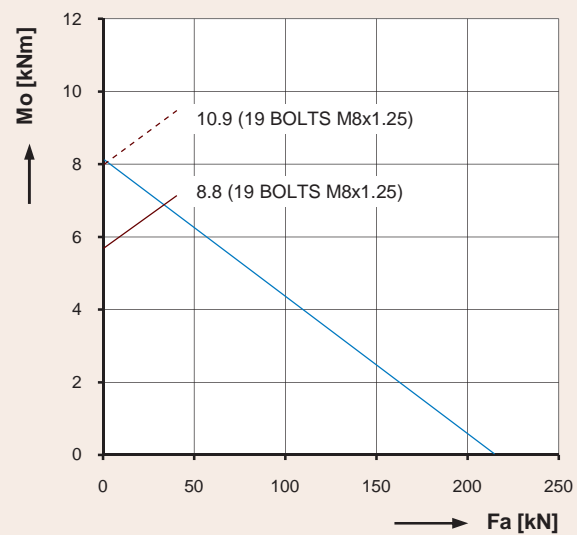

90-1B10-0179-0670

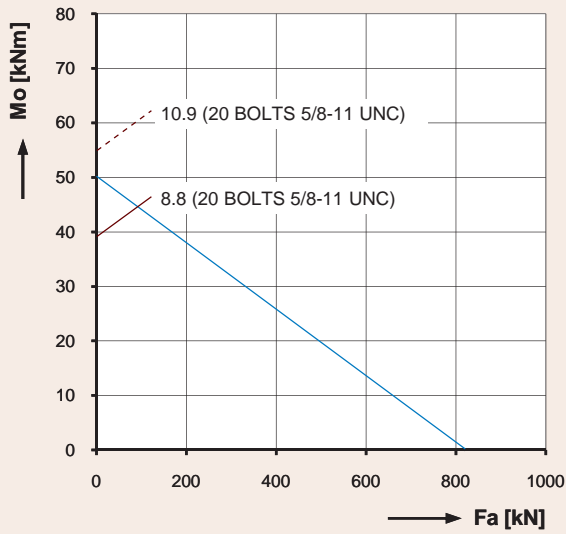

9E-1B20-0289-0674

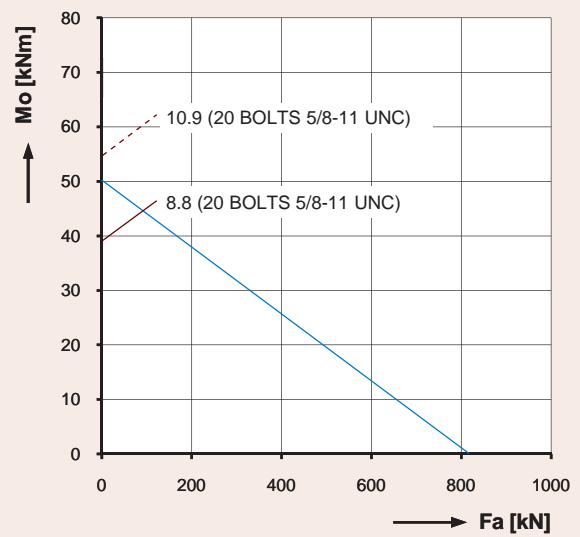

9E-1B20-0289-0674-2

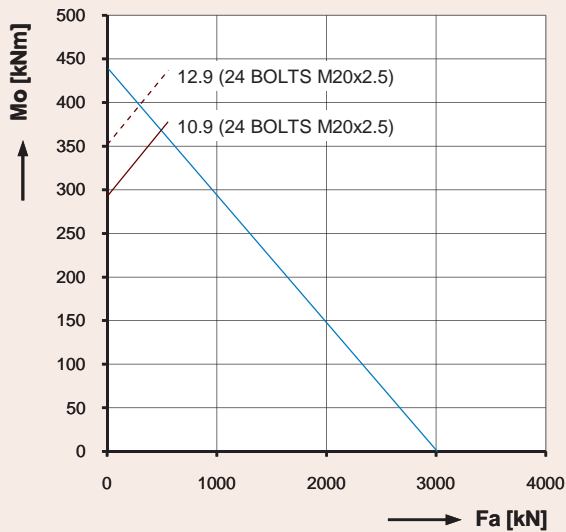

9E-1B30-0685-0677

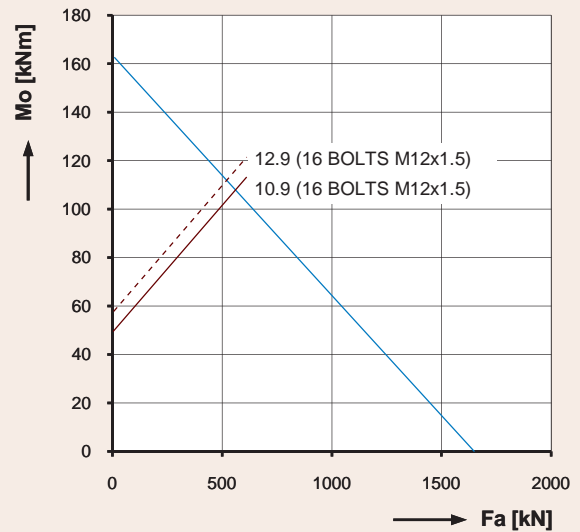

9I-1B22-0465-0681

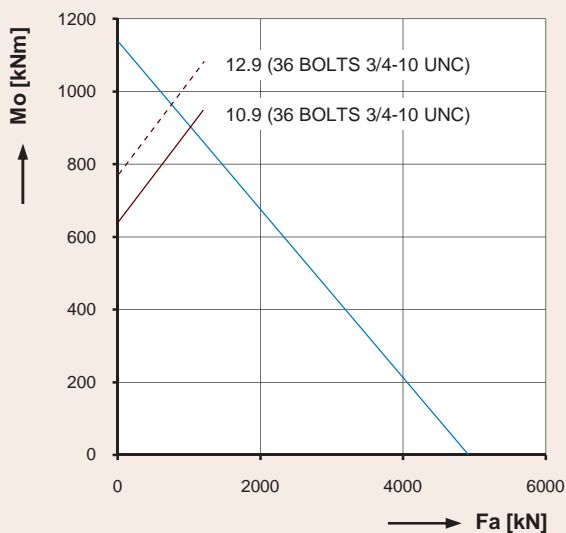

9I-1B32-1088-0689

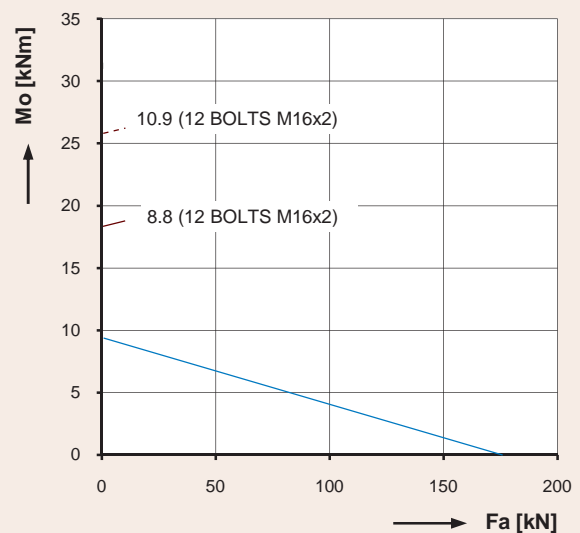

9E-1Z12-0215-0694

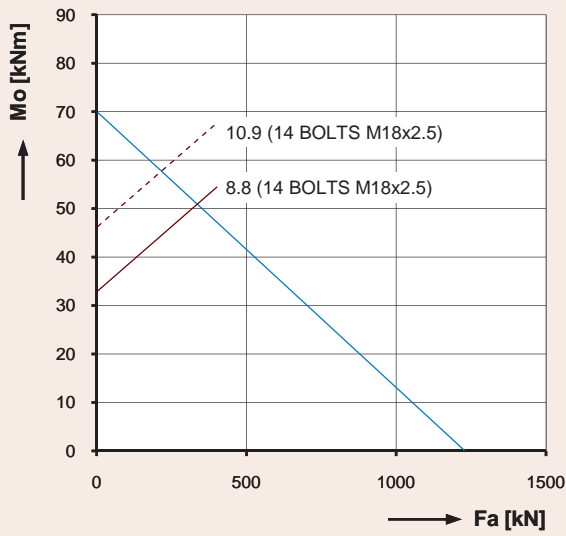

9O-2B20-0268-0702

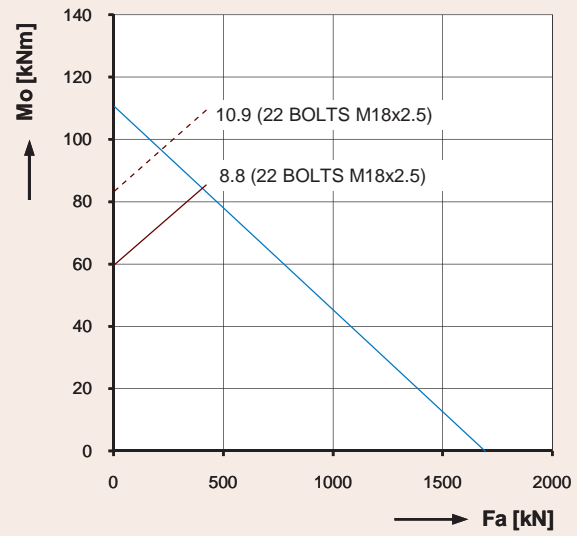

9O-2B25-0308-0703

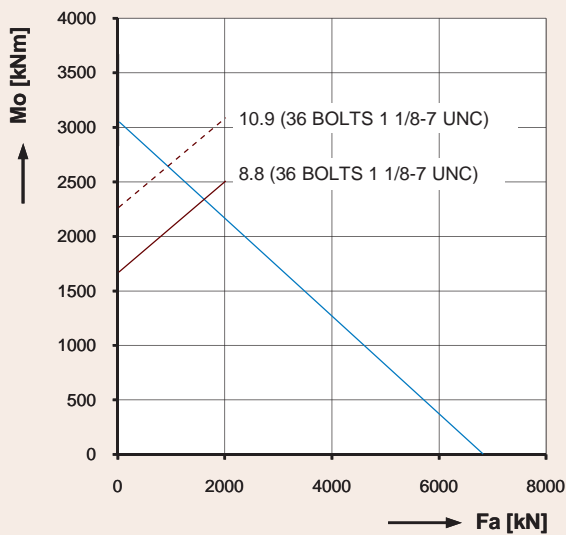

9E-1Z45-1791-0706

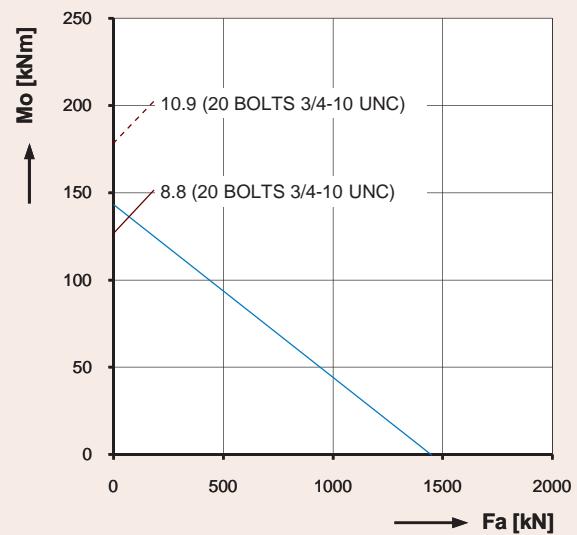

9E-1B22-0462-0709

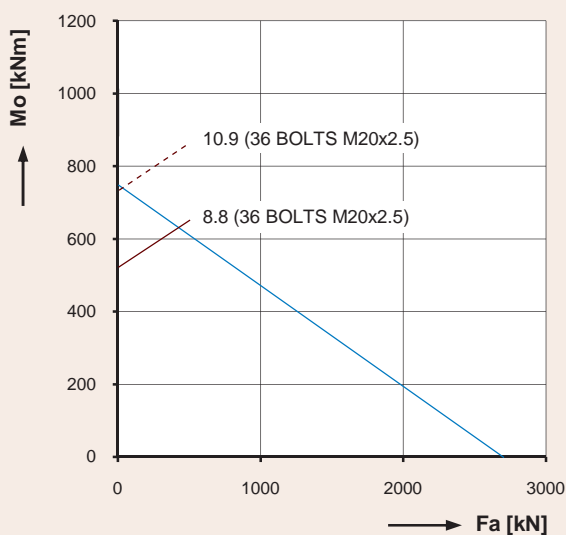

9E-1Z30-1110-0710

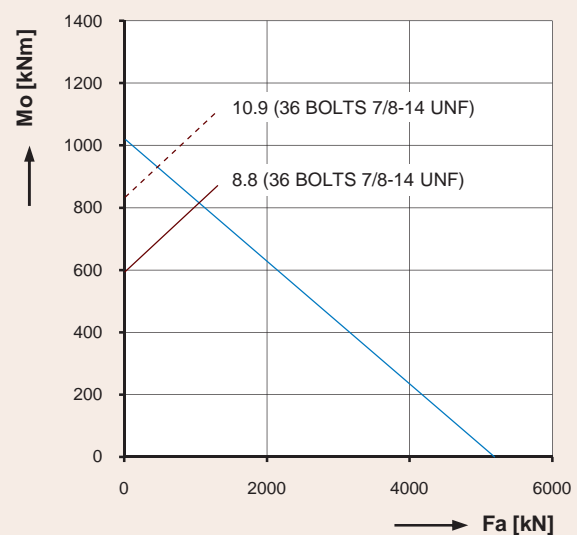

9I-1B40-0923-0713

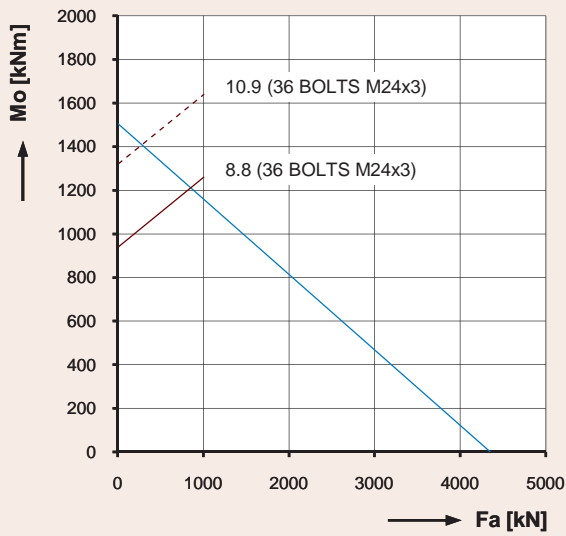

9I-1Z40-1385-0715

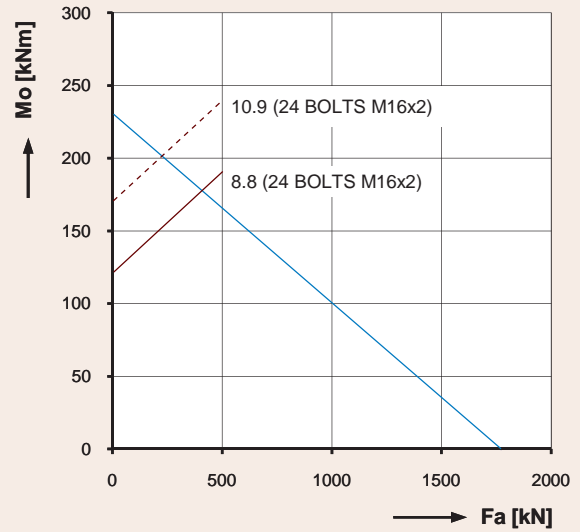

9E-1B20-0613-0717

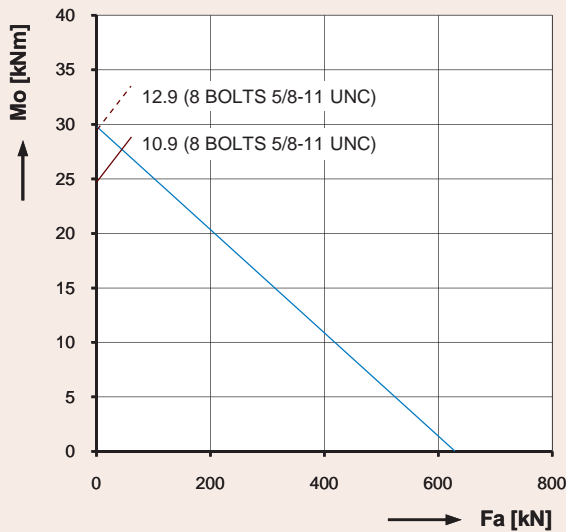

9E-1B20-0223-0718

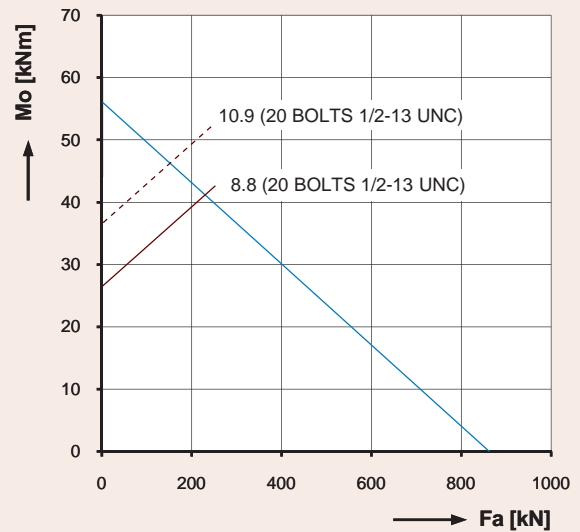

9E-1B20-0307-0733

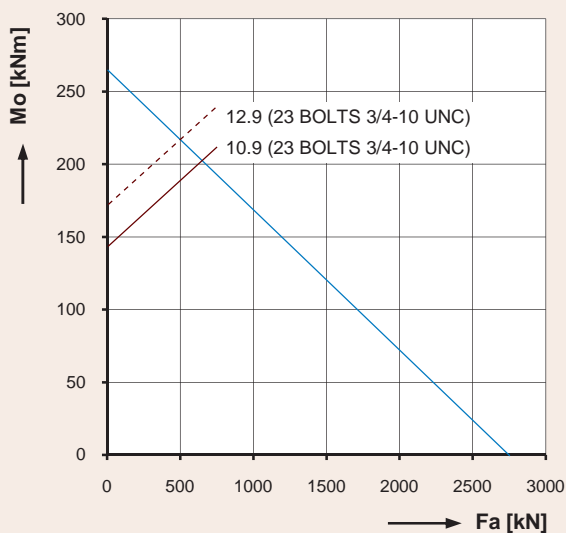

9E-1B45-0452-0742

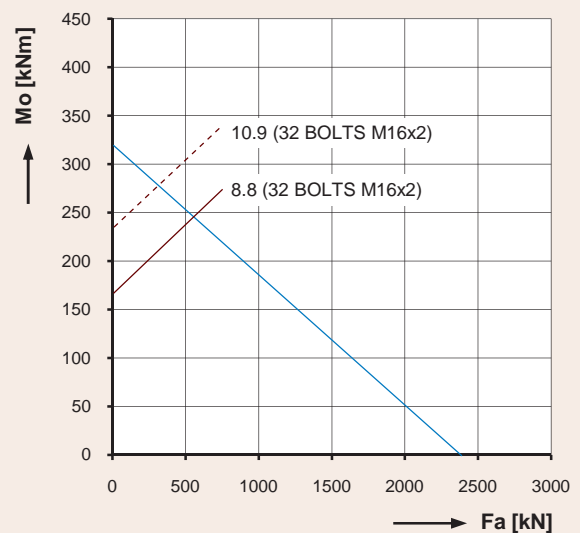

9I-1B25-0632-0751

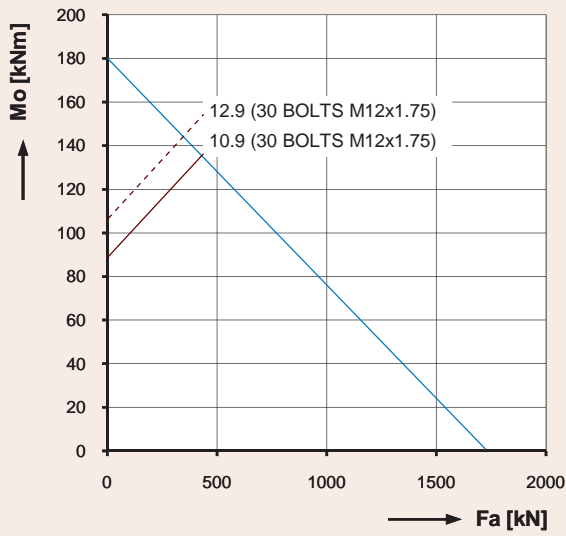

9I-1B25-0489-0752

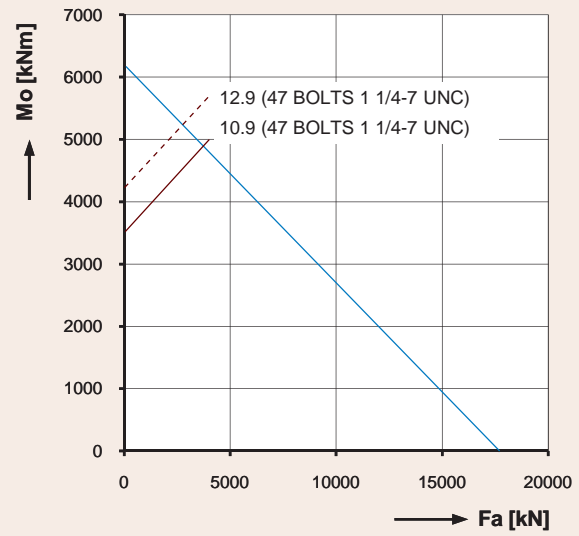

9E-1B75-1641-0753

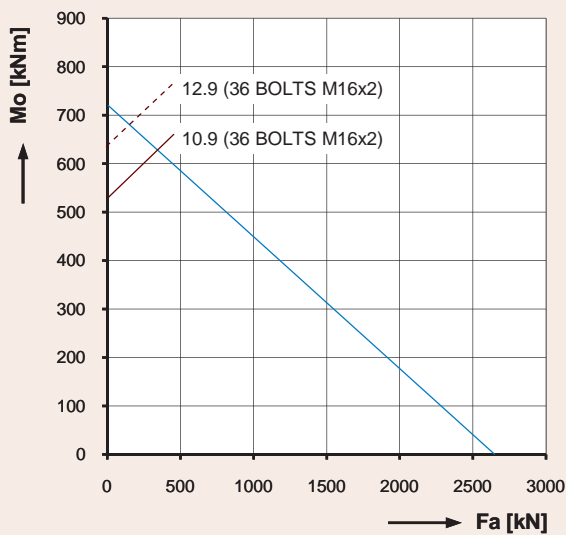

9I-1Z30-1090-0756

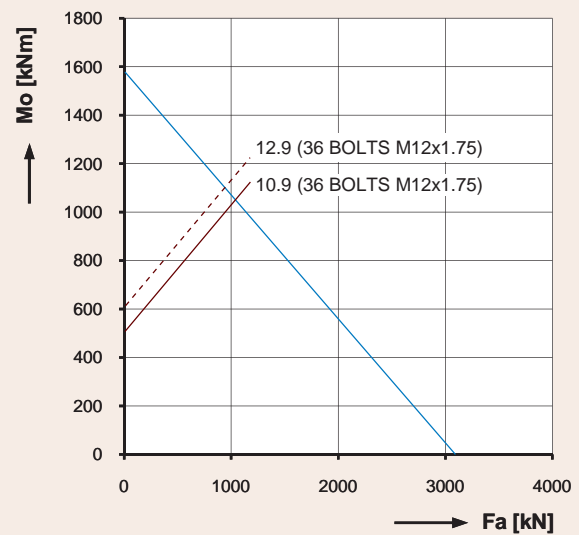

9O-1Z20-2045-0757

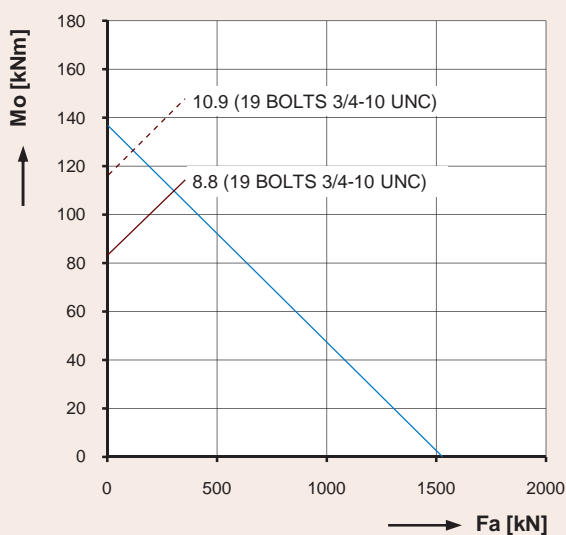

9E-1B25-0422-0761

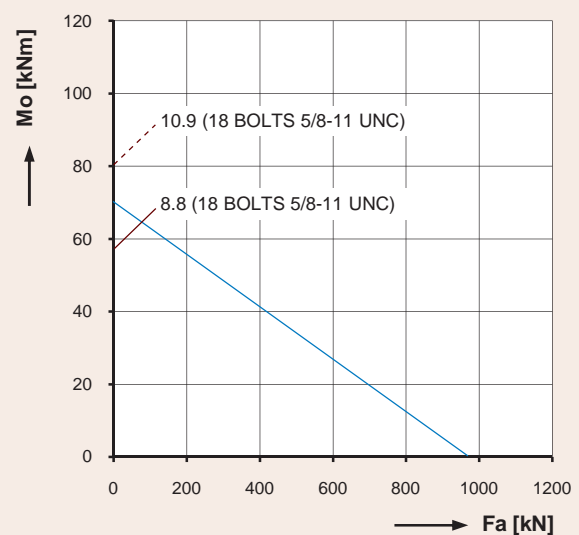

9E-1B20-0343-0762

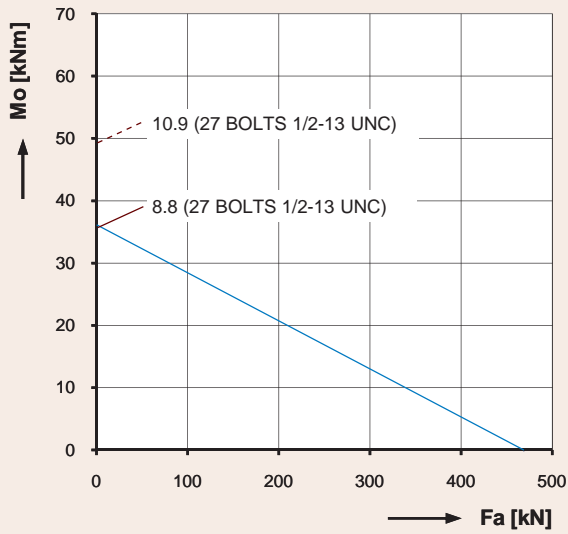

9E-1Z20-0309-0765

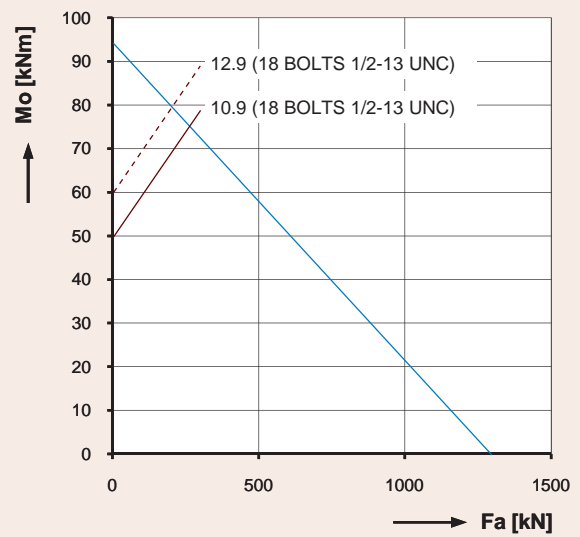

9E-1B22-0343-0768

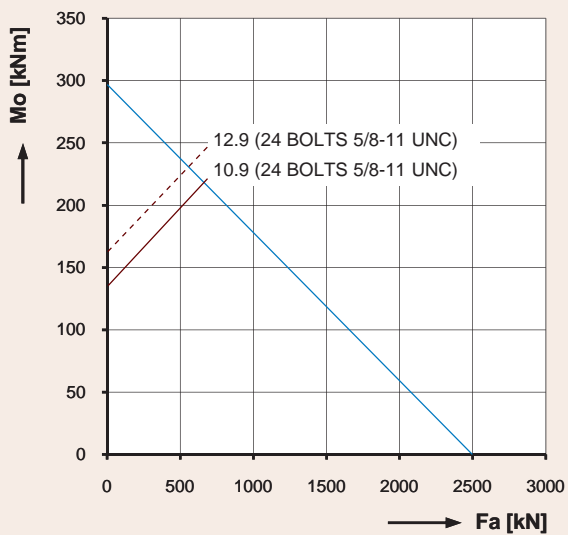

9I-1B25-0560-0770

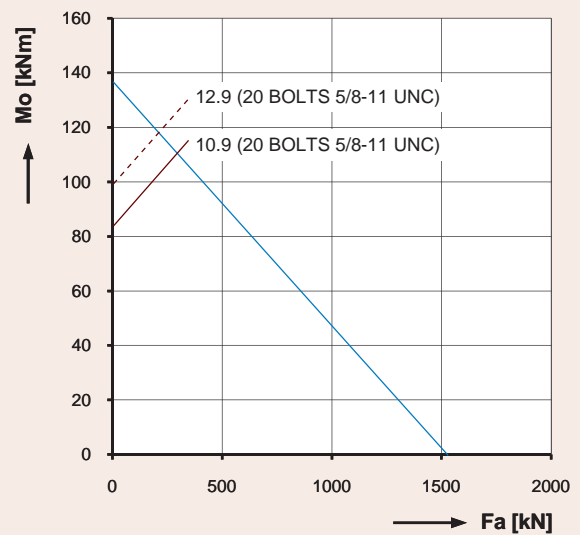

9E-1B25-0422-0779

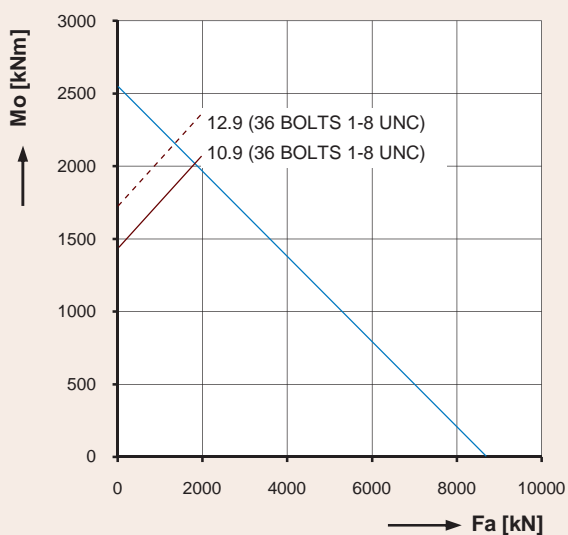

9I-1B45-1378-0781

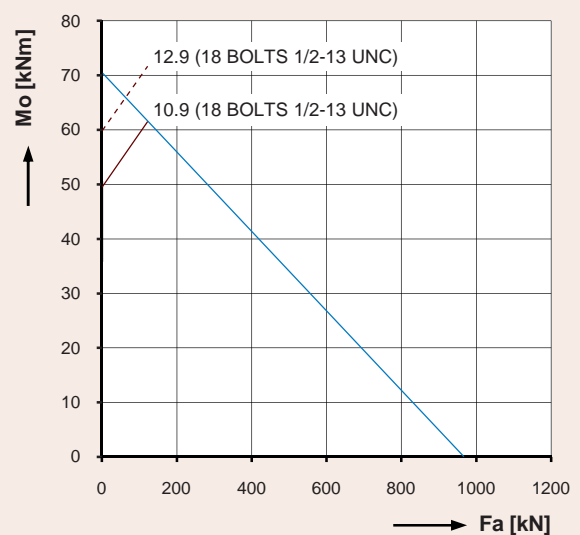

9O-1B20-0342-0789



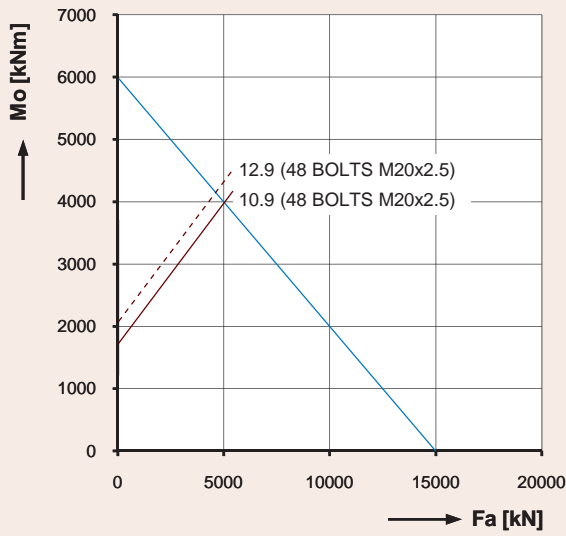

9E-2B30-1875-0790

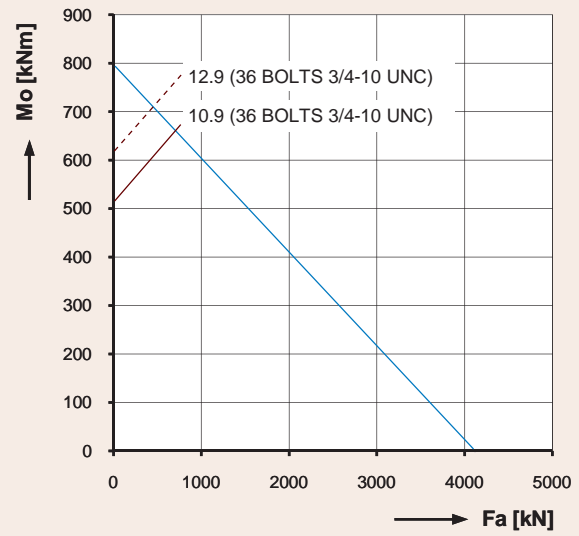

9O-1B32-0910-0791

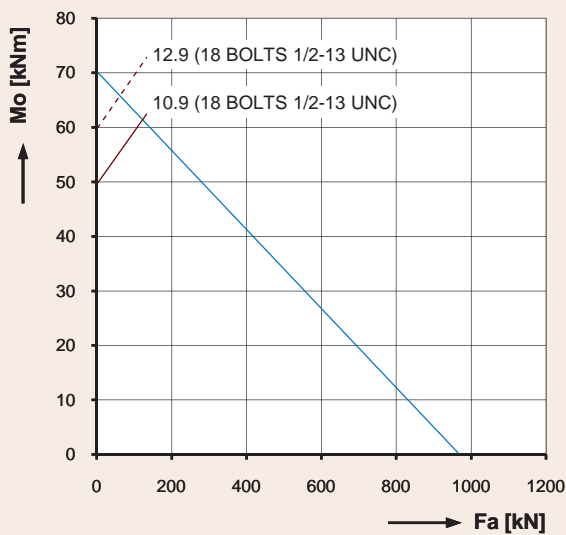

9O-1B20-0342-0793

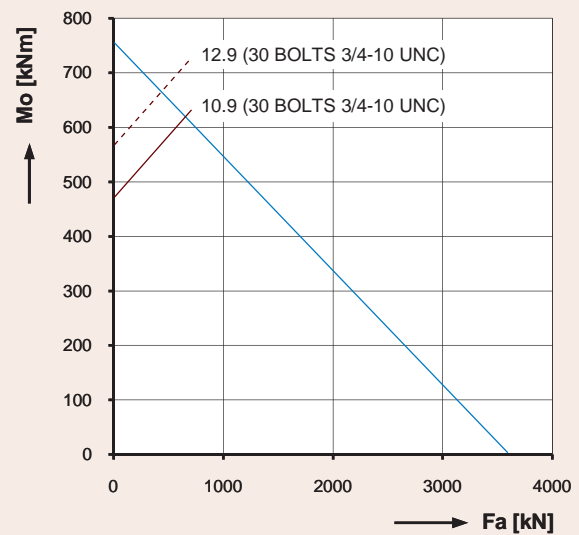

9E-1B25-0985-0796

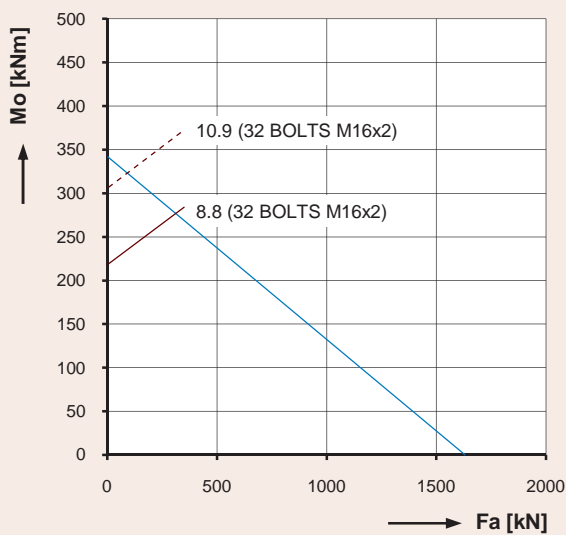

9O-1Z25-0839-0799

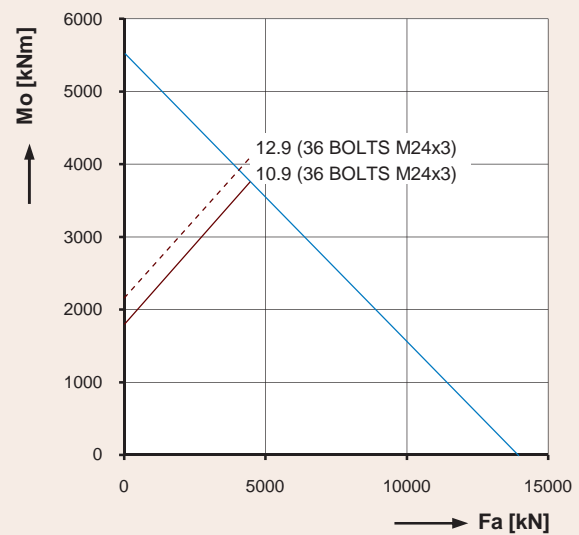

9E-1B50-1865-0812

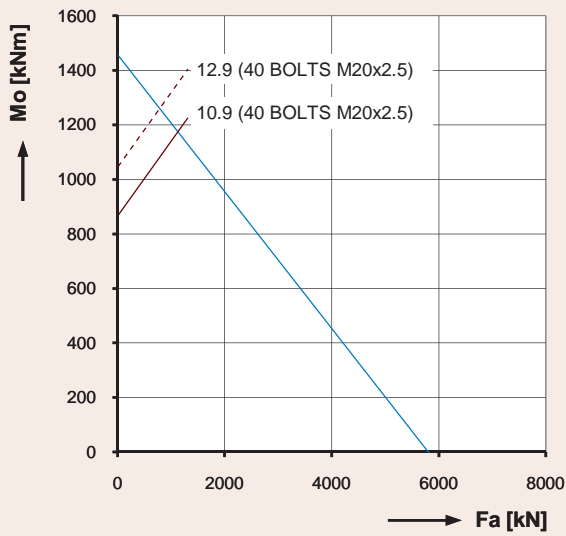

9E-1B35-1180-0813

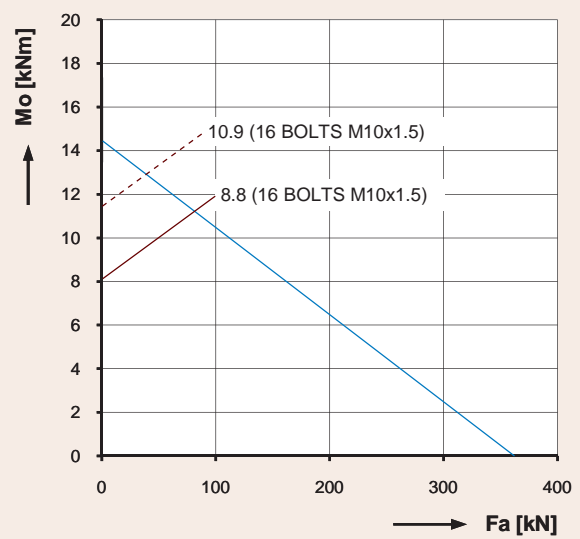

9E-1B16-0188-0815

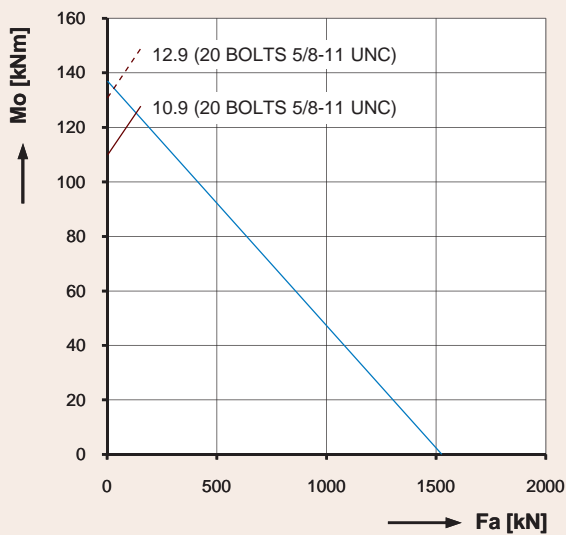

9E-1B25-0422-0816

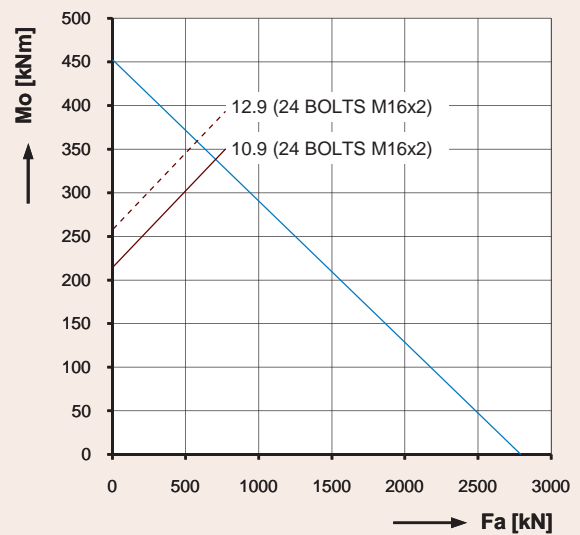

9O-1B25-0763-0831

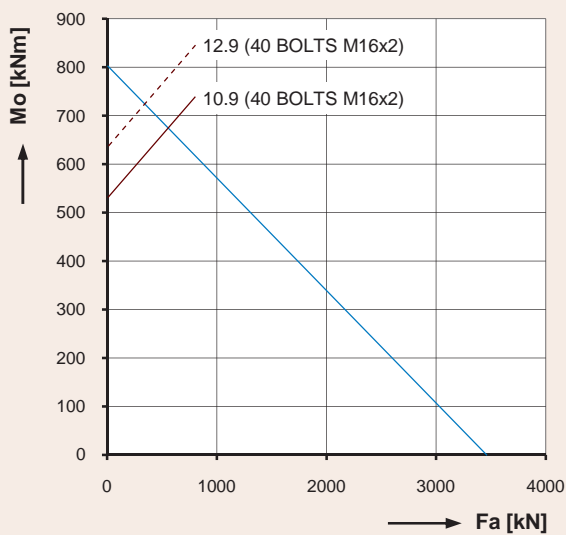

9I-1B22-1090-0832

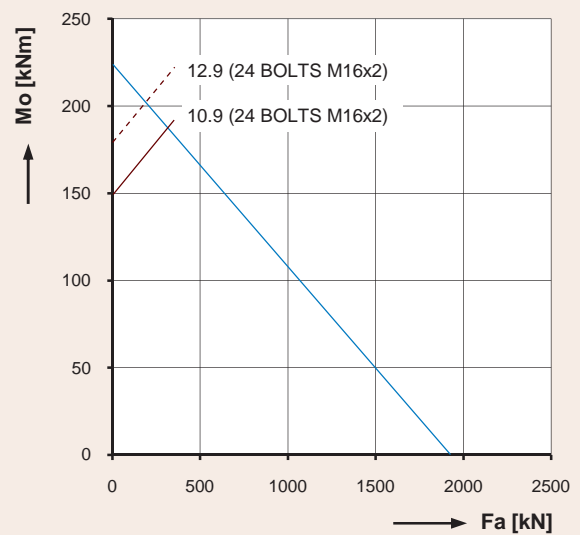

9I-1B25-0547-0834

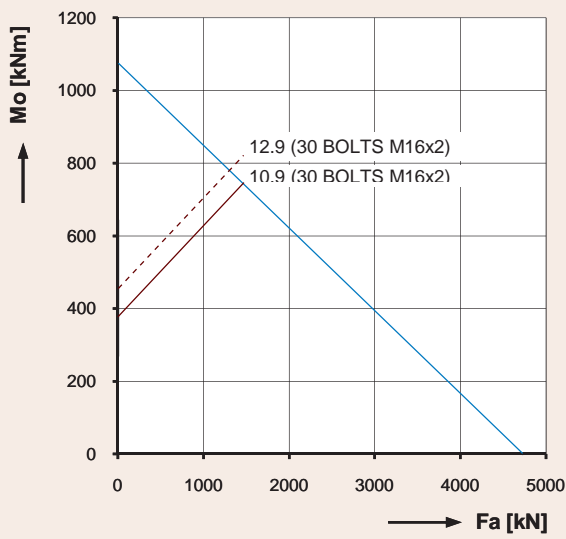

9E-1B30-1072-0836-1

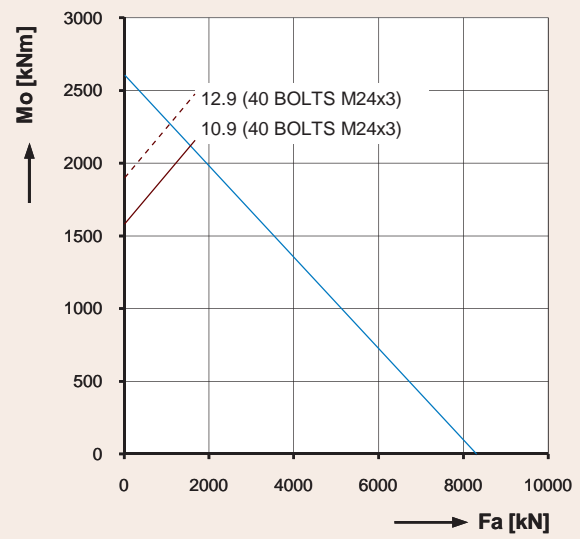

9E-1B40-1476-0838

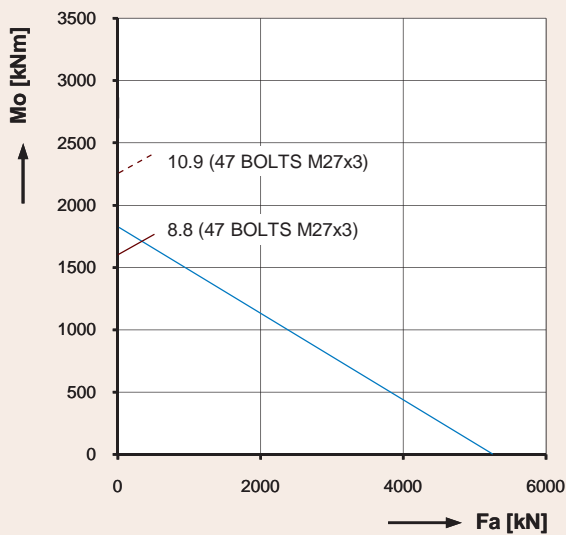

9E-1Z45-1390-0841

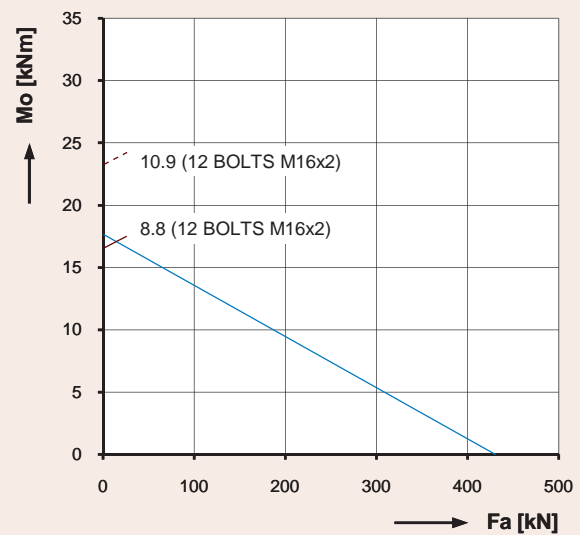

9O-1B14-0193-0850-1

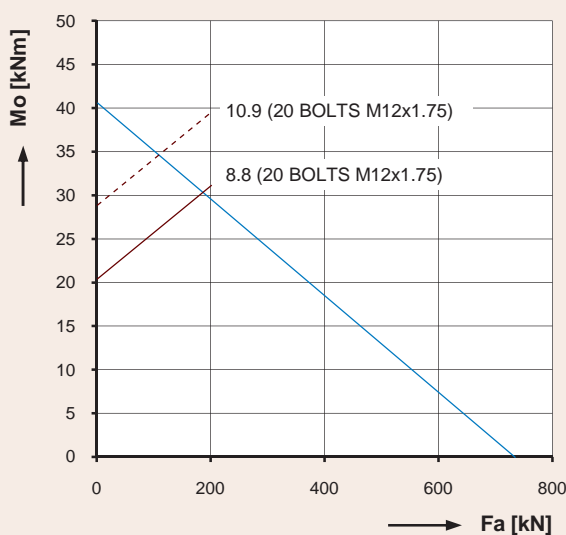

9O-1B20-0260-0851

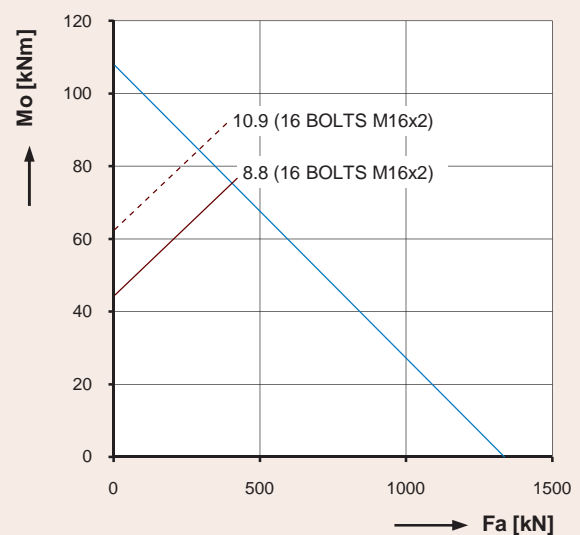

9O-1B25-0380-0852

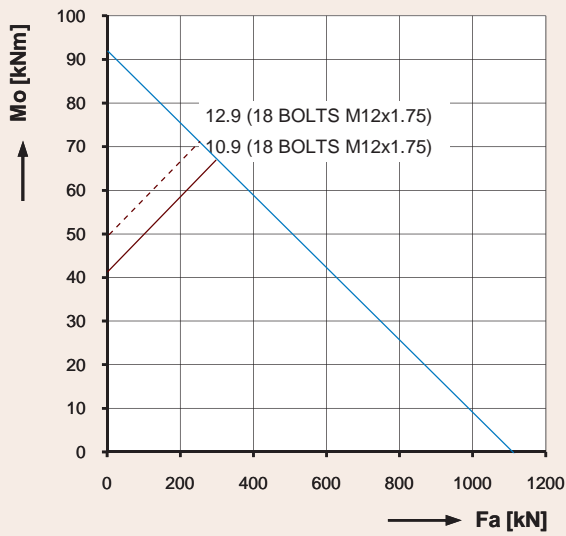

9I-1B20-0388-0856

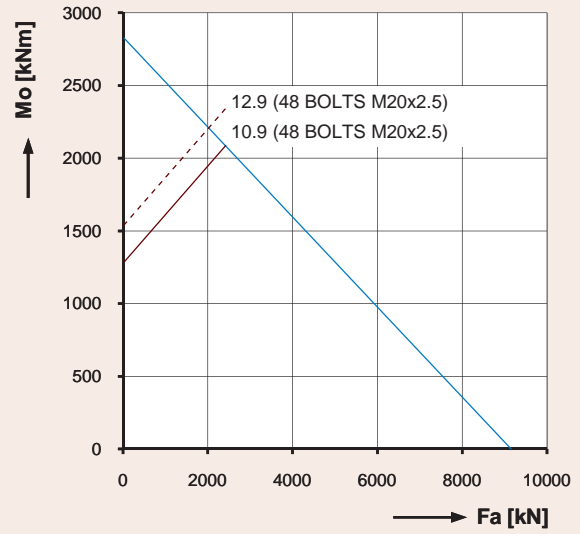

9O-1B45-1455-0857

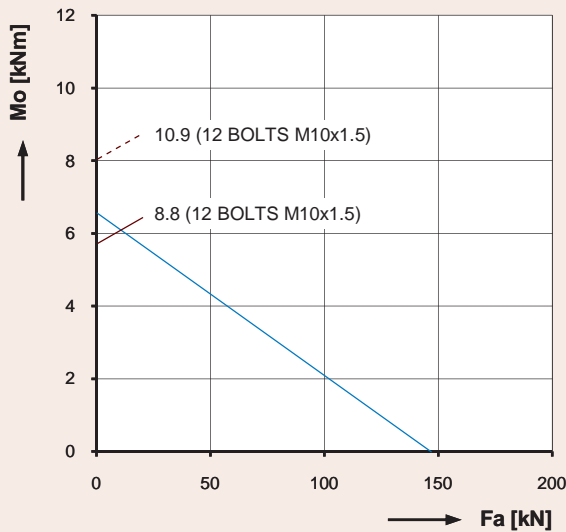

9O-1Z12-0179-0858

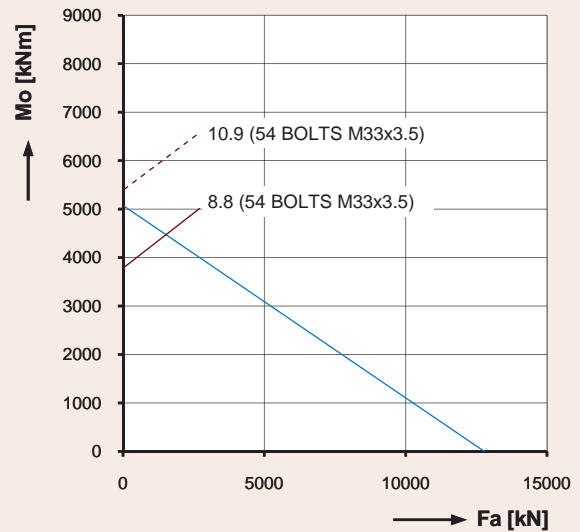

9I-1B45-1864-0859

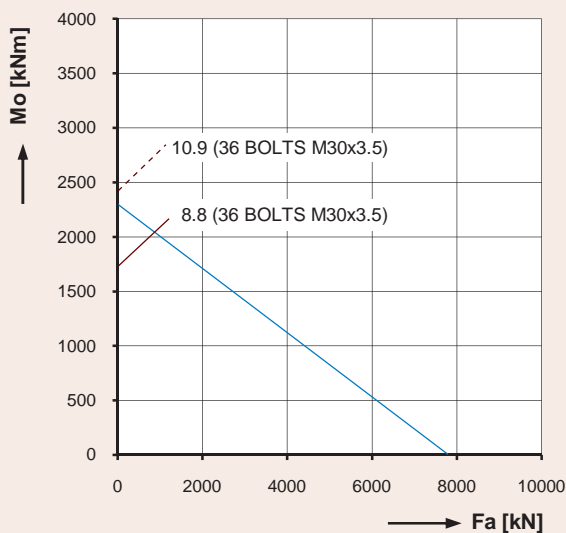

9I-1B40-1385-0860

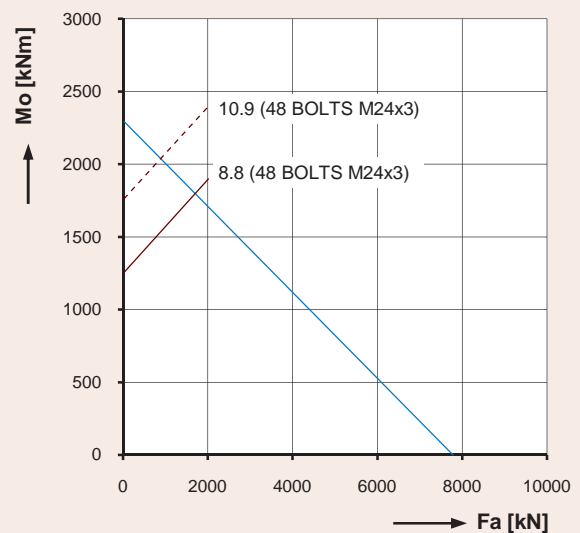

9I-1B40-1385-0861

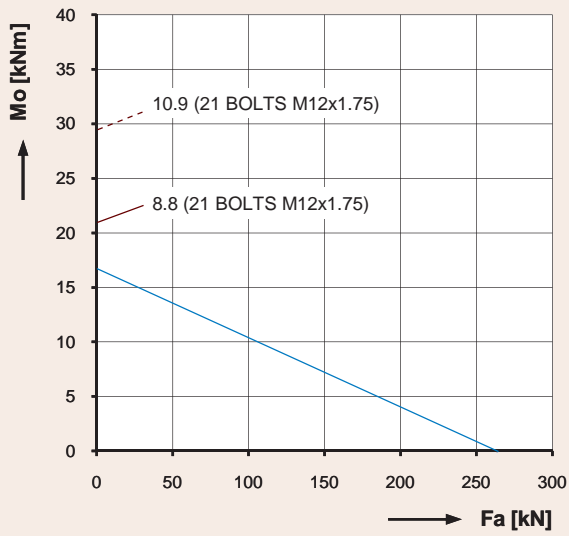

9E-1Z14-0254-0862

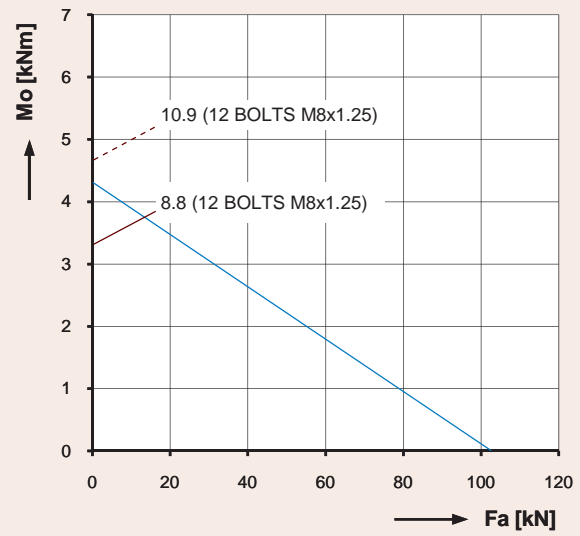

9O-1Z08-0168-0864

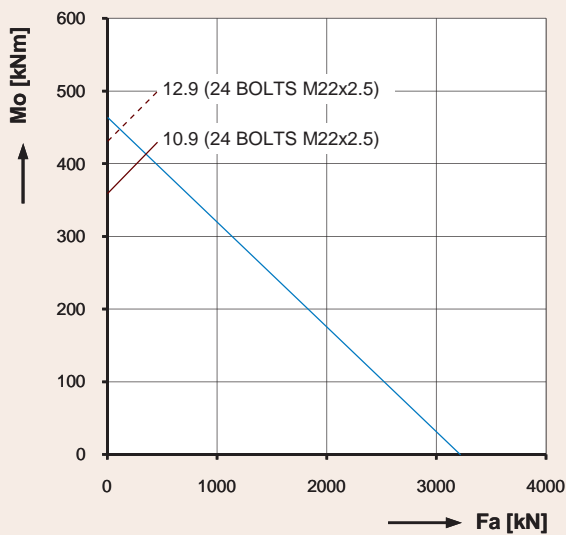

9E-1B30-0678-0868

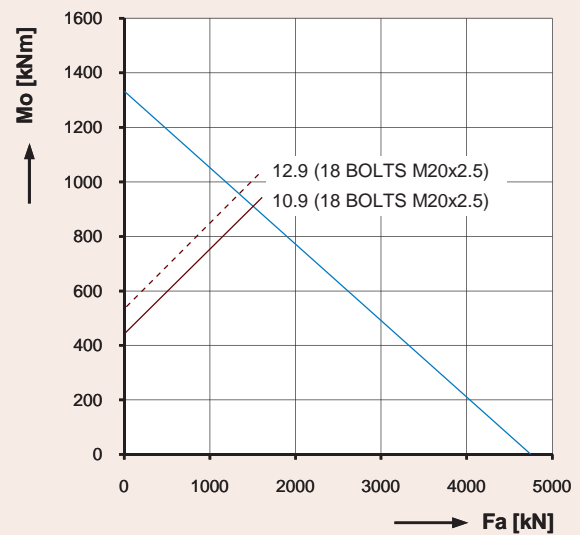

9I-1B25-1321-0881

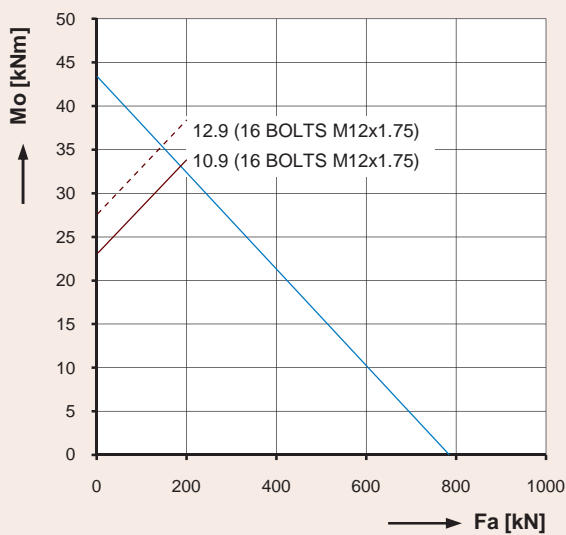

9O-1B22-0260-0884

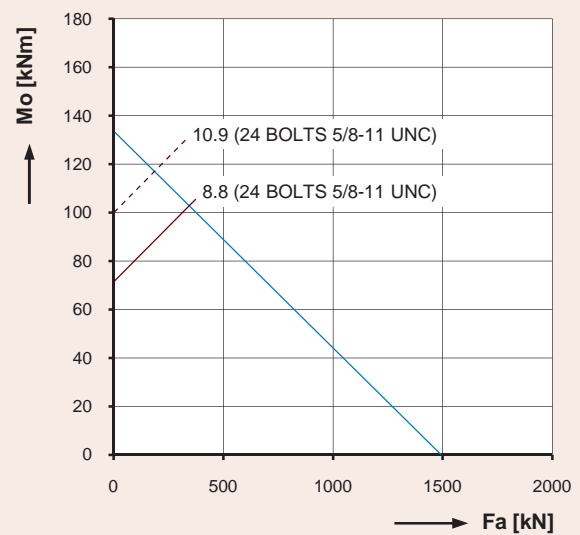

9I-1B25-0421-0893

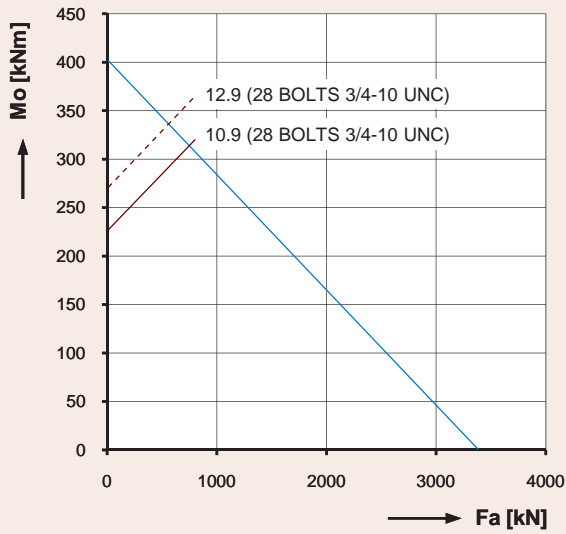

9E-1B45-0559-0897

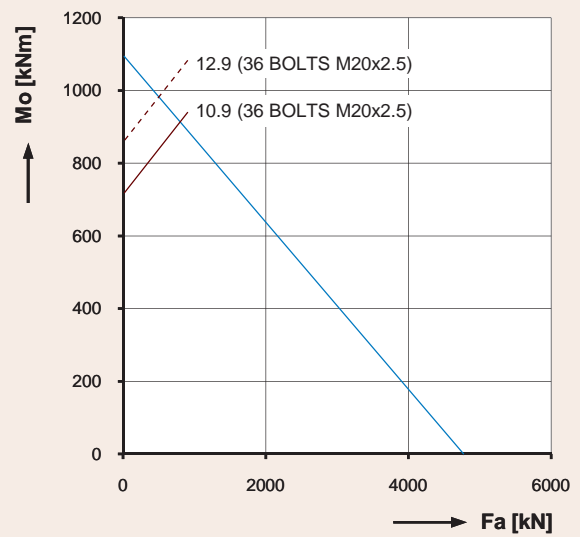

9O-1B30-1079-0898

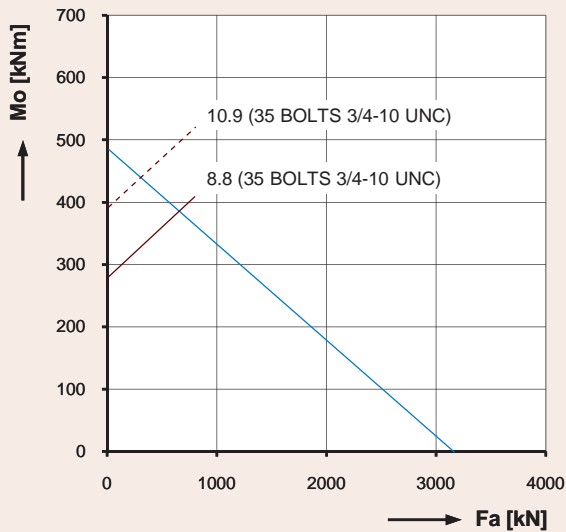

9E-1B30-0725-0900

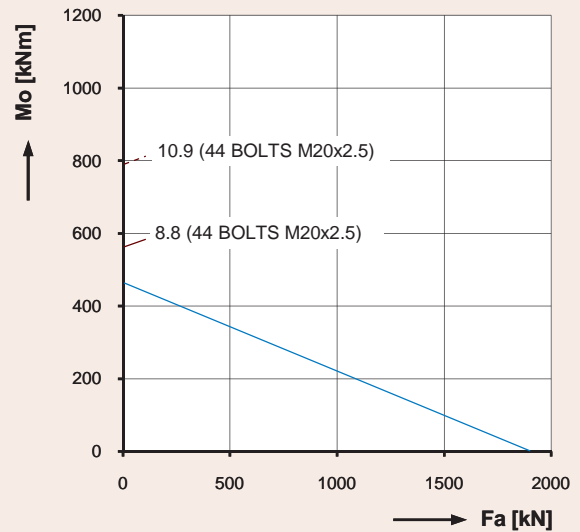

9O-1Z25-0980-0902

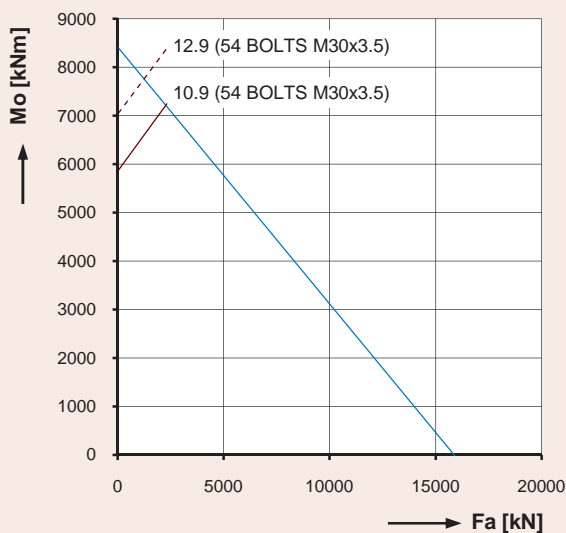

9I-1B45-2490-0907

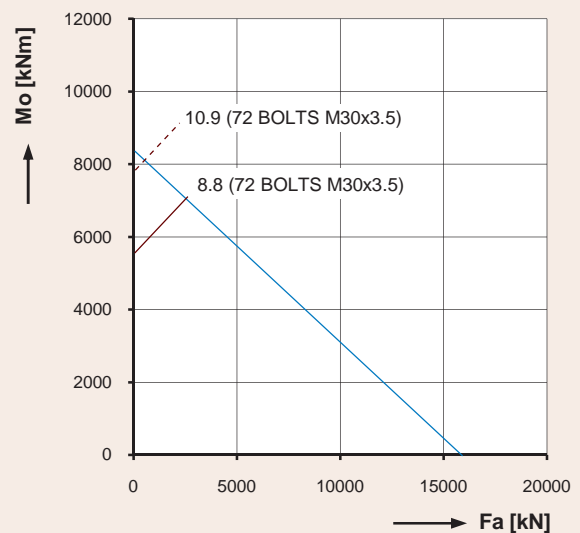

9I-1B45-2490-0907-1

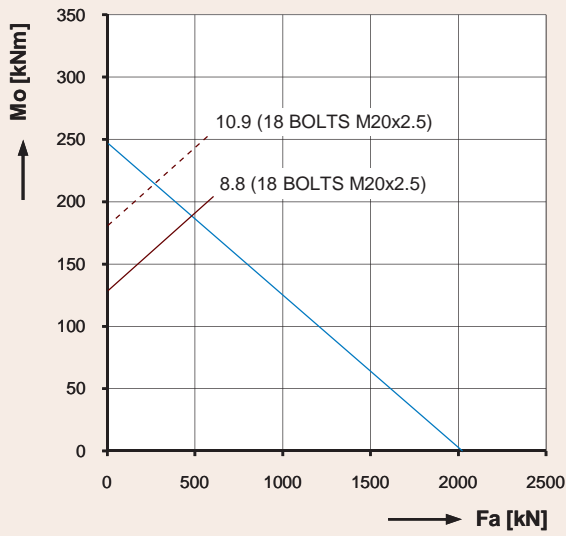

9E-1B25-0574-0924

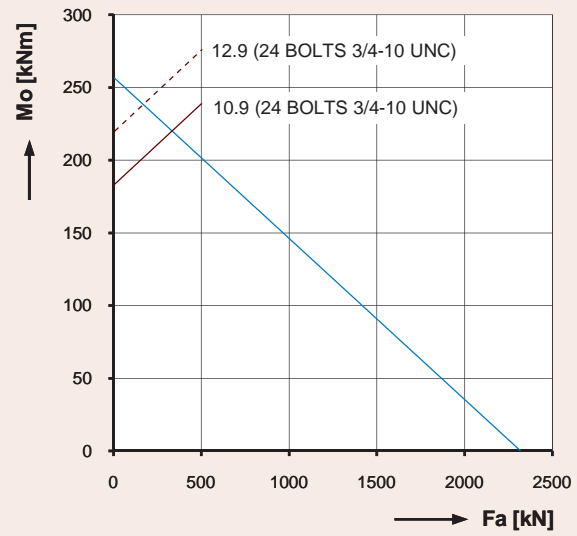

9E-1B32-0521-0926

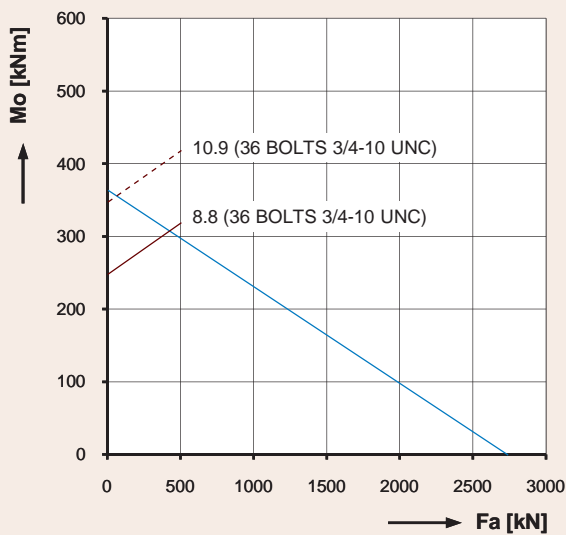

9I-1B30-0626-0929

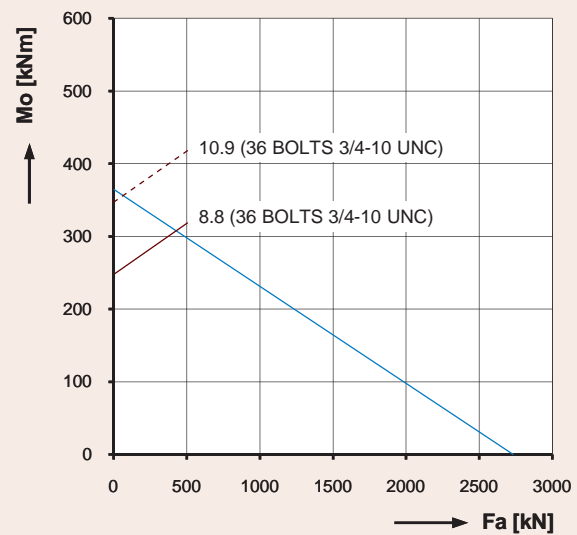

9I-1B30-0626-0929-1

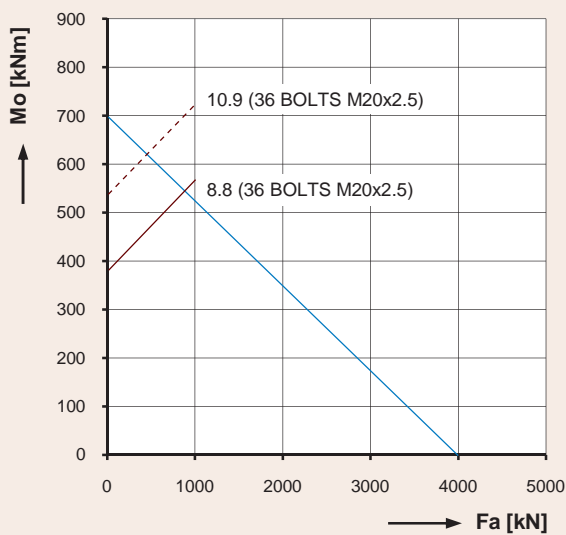

9E-1B35-0823-0933

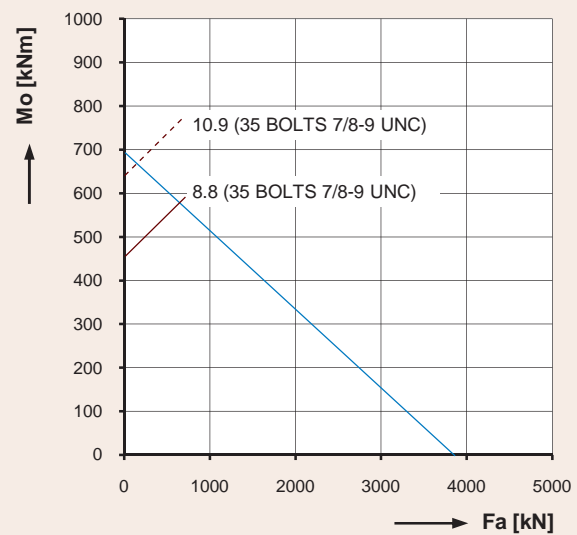

9E-1B32-0848-0938

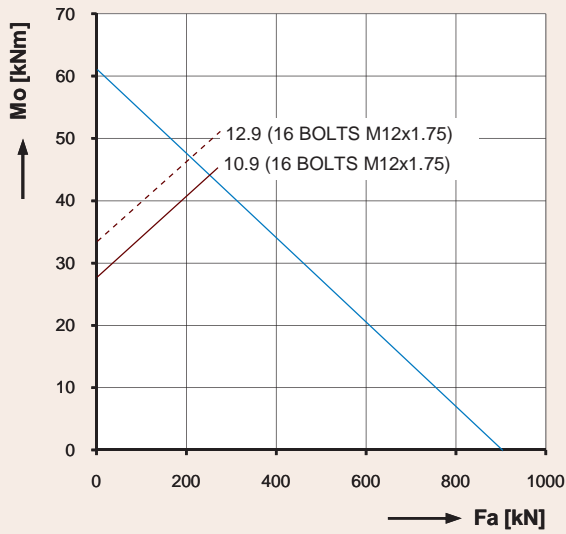

9O-1B20-0318-0945

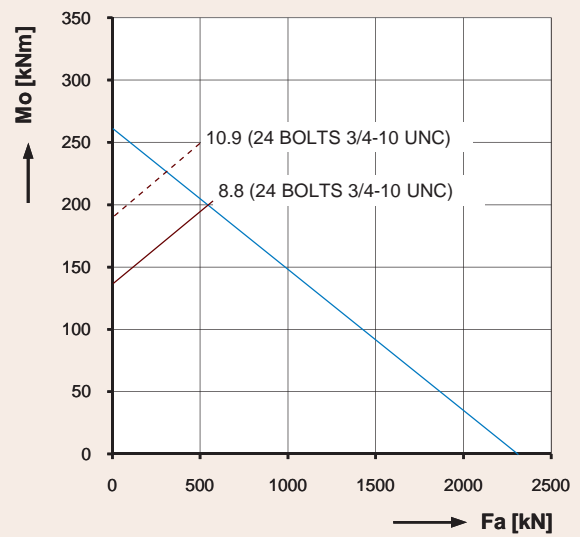

9E-1B30-0533-0947

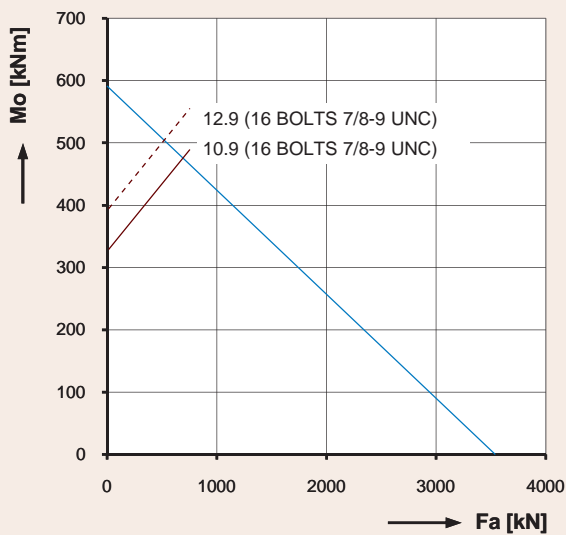

9I-1B32-0788-0950

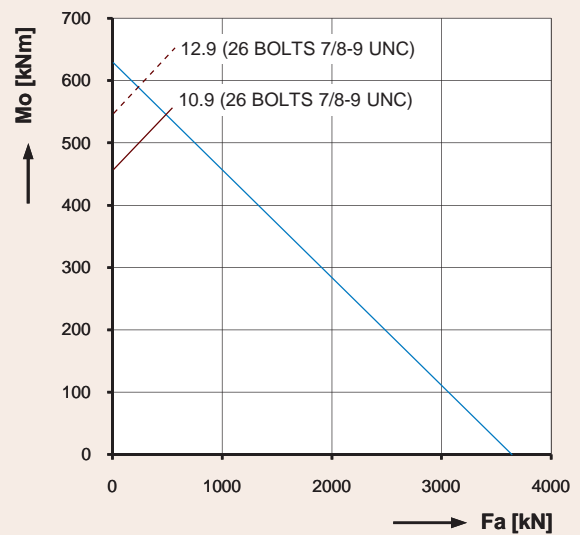

9I-1B32-0813-0951

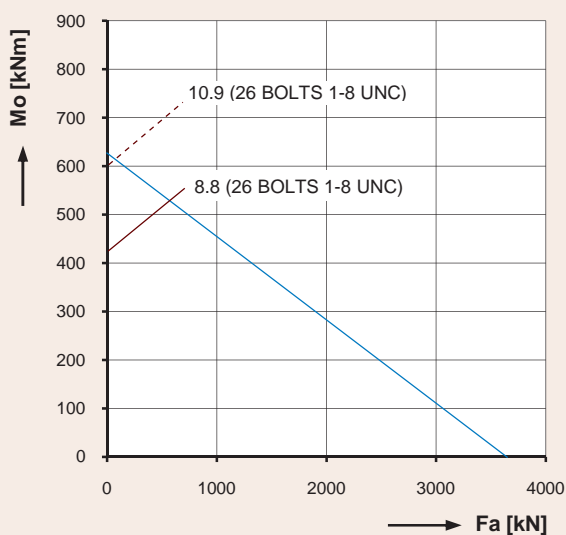

9I-1B32-0813-0952

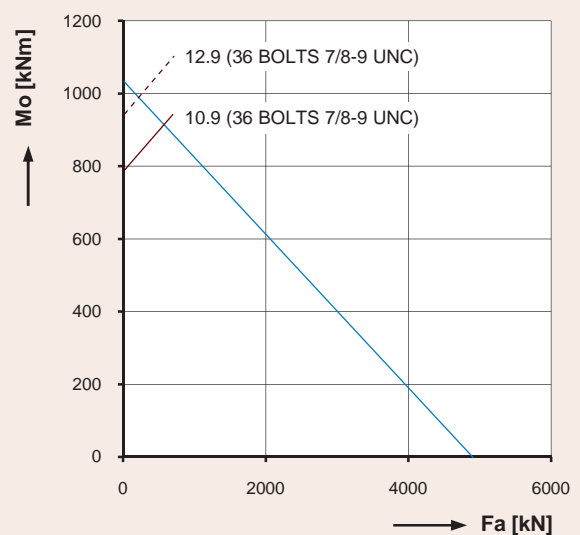

9E-1B35-0995-0954



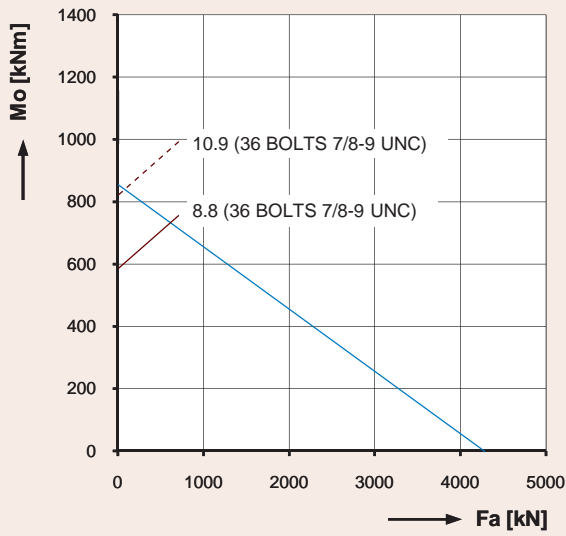

9E-1B32-0940-0960

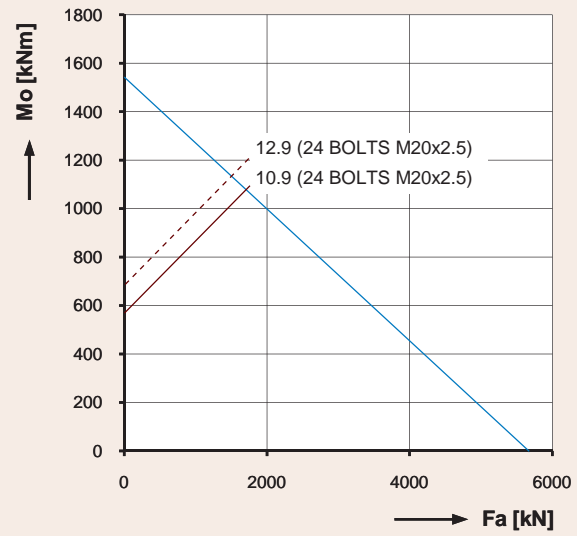

9I-1B30-1280-0963

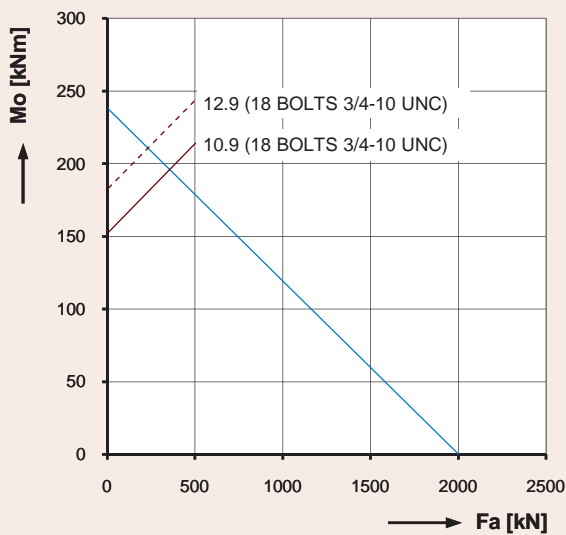

9E-1B25-0559-0964-1

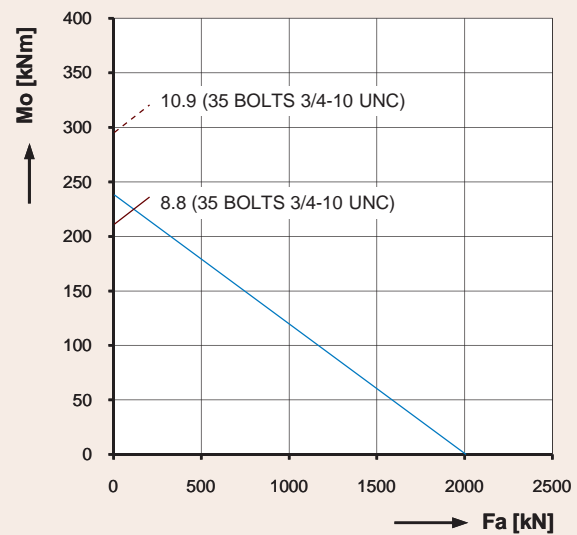

9E-1B25-0559-0964-2

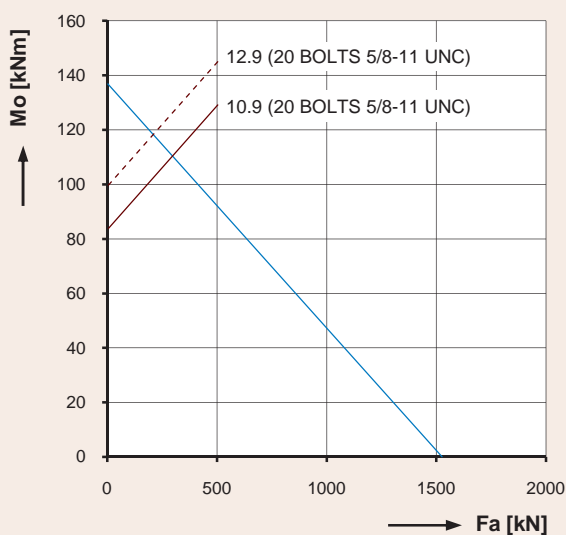

9E-1B25-0422-0966

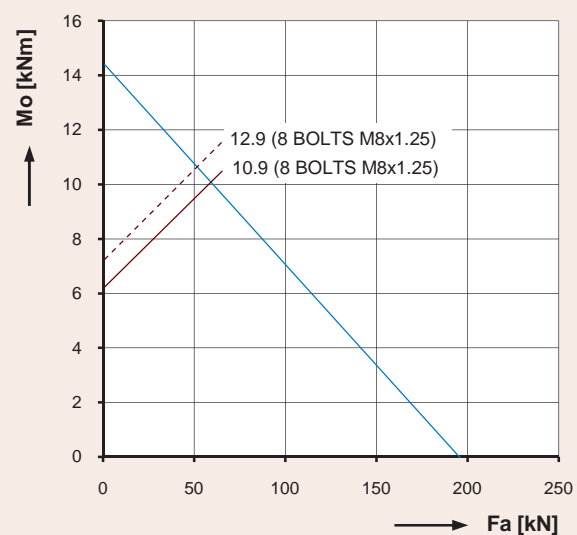

9O-1Z10-0295-0972

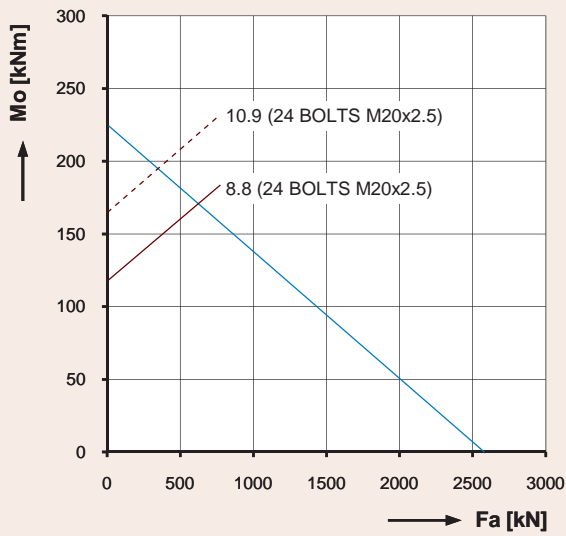

9O-2B25-0410-0974

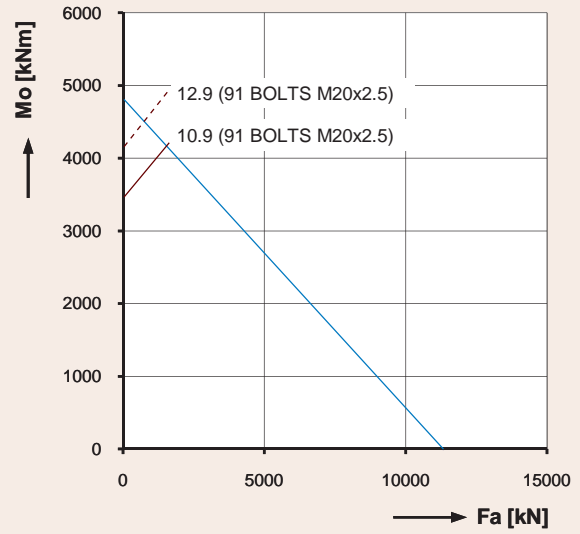

9O-1B40-2000-0980

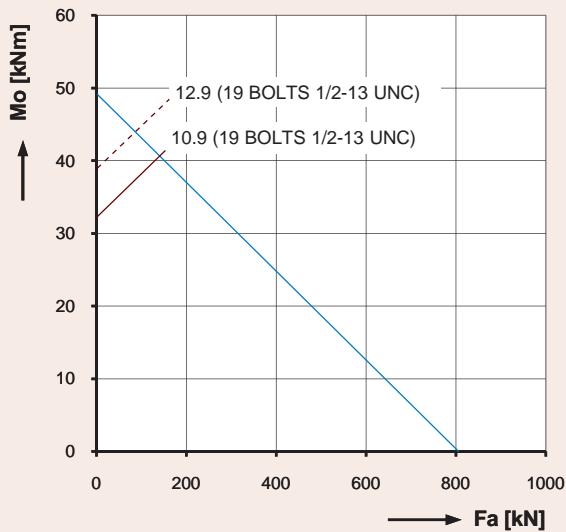

9E-1B20-0287-0983

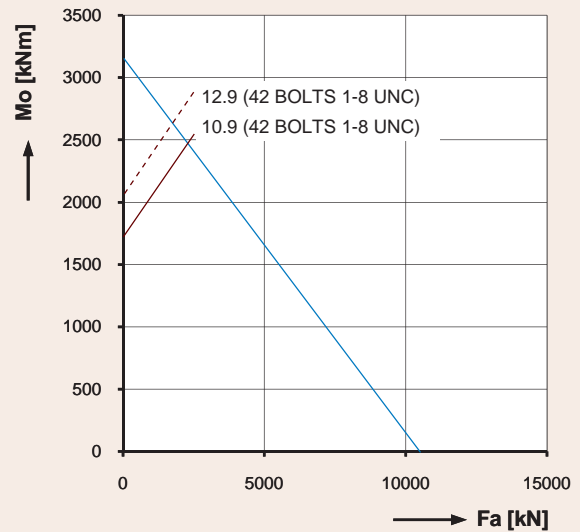

9I-1B50-1416-0985

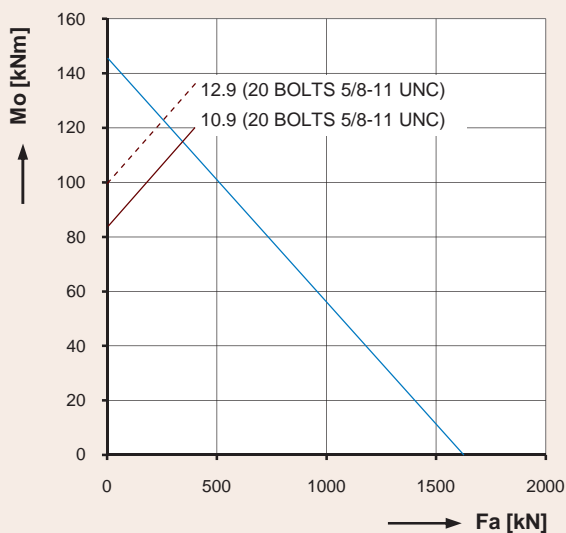

9E-1B25-0422-0989

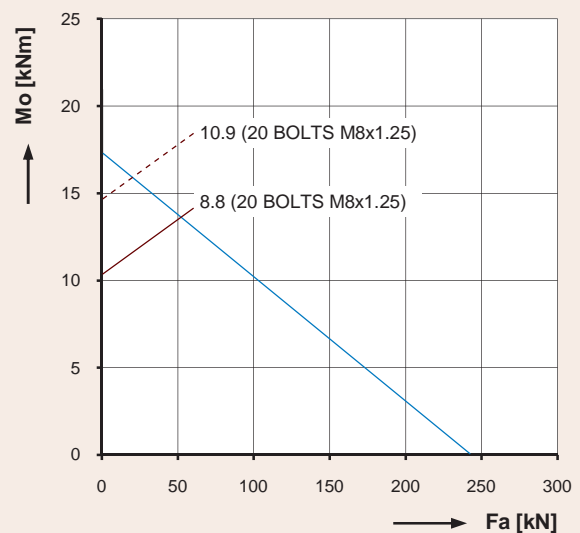

9I-1Z12-0288-0991

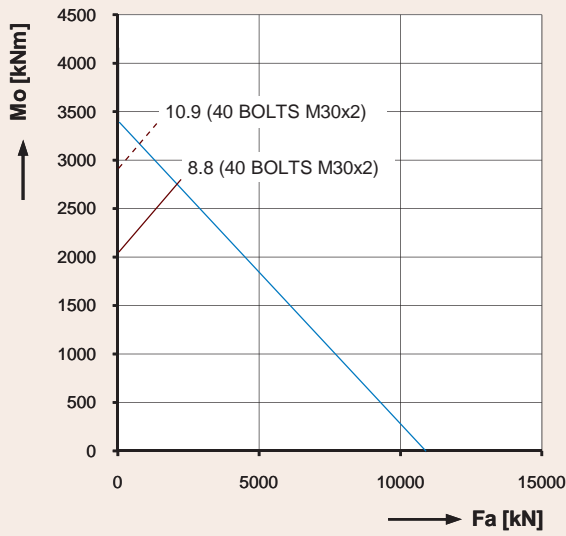

9I-1B50-1466-0994

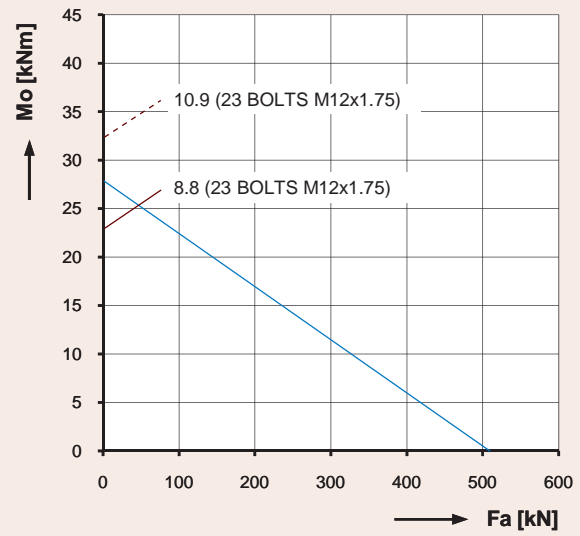

9E-1B16-0258-0996

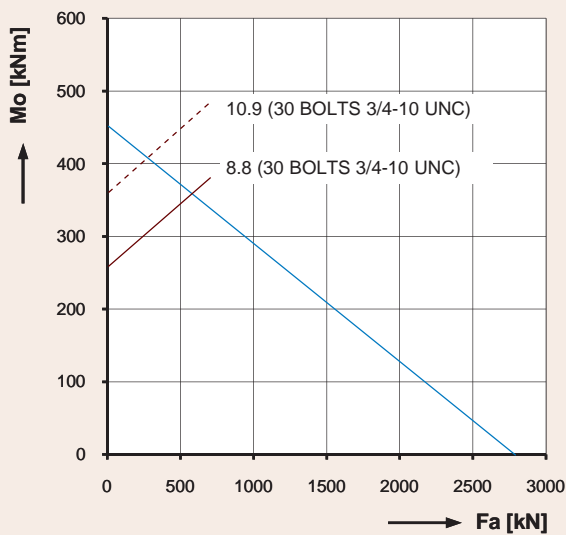

9E-1B25-0762-0998

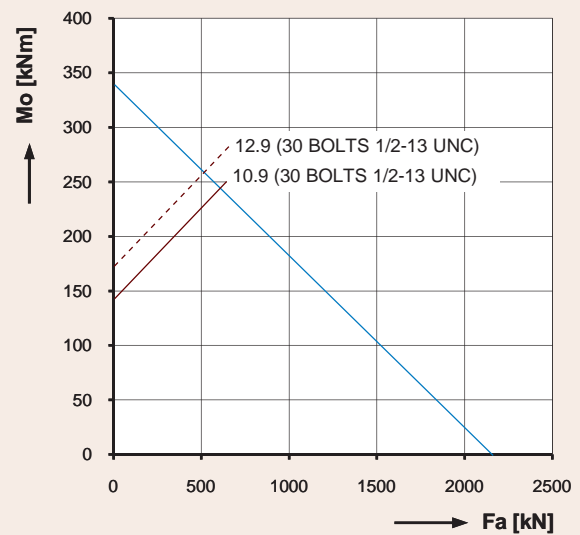

9E-1B20-0741-0999

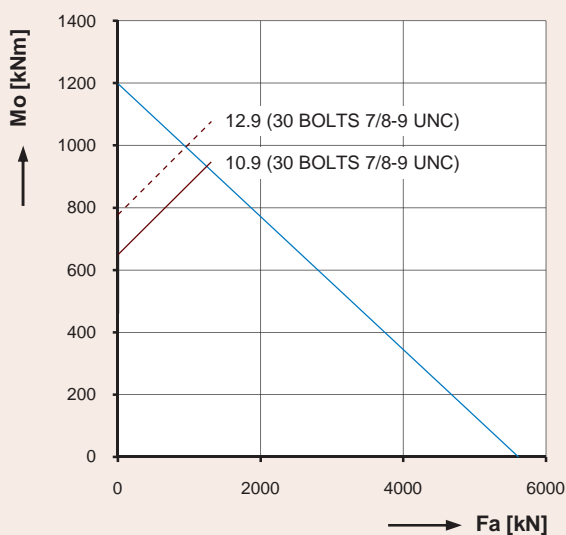

9E-1B40-1002-1000

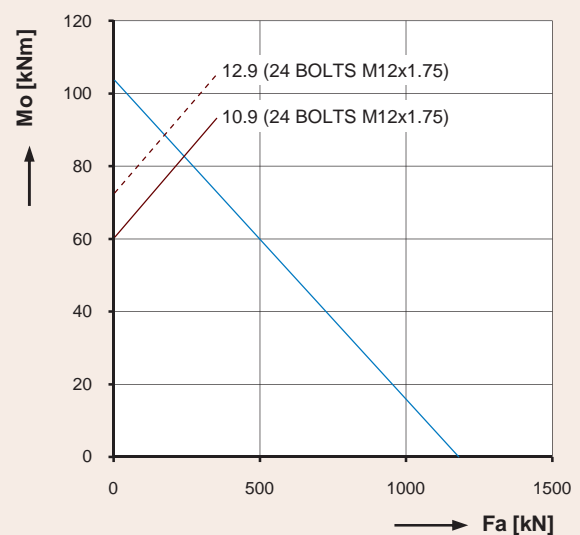

9I-1B20-0414-1014

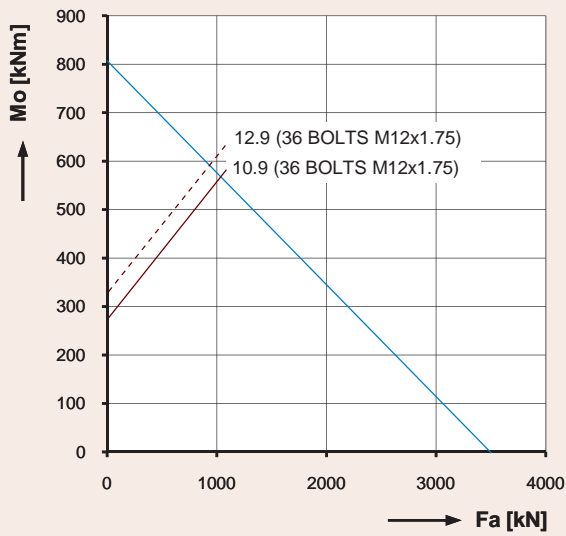

9E-1B22-1087-1015

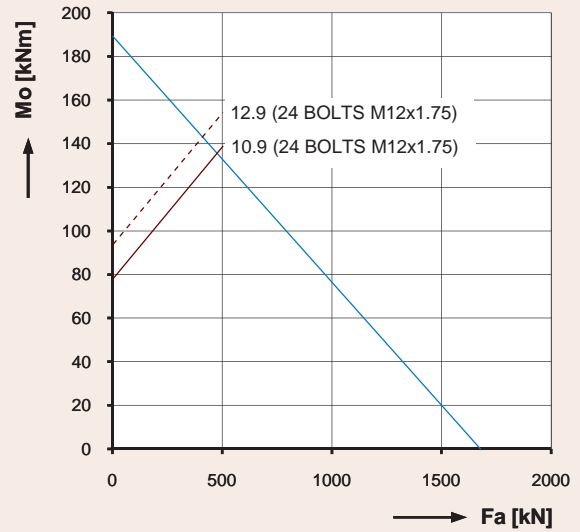

9O-1B22-0530-1019

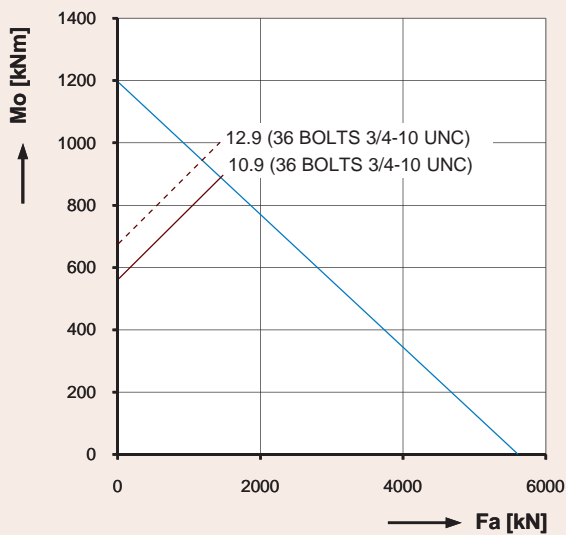

9E-1B40-1002-1025

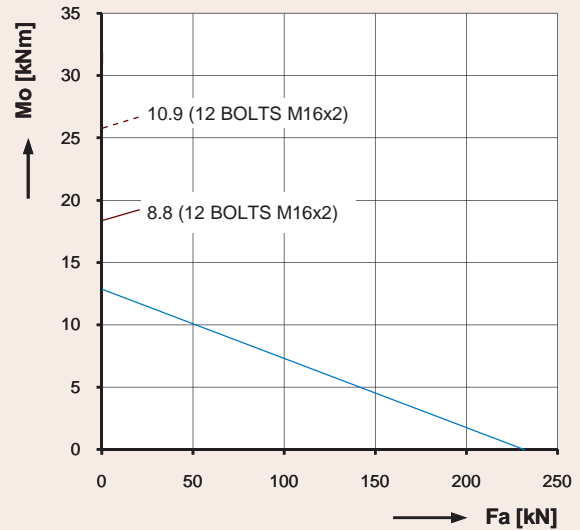

9O-1Z14-0222-1026

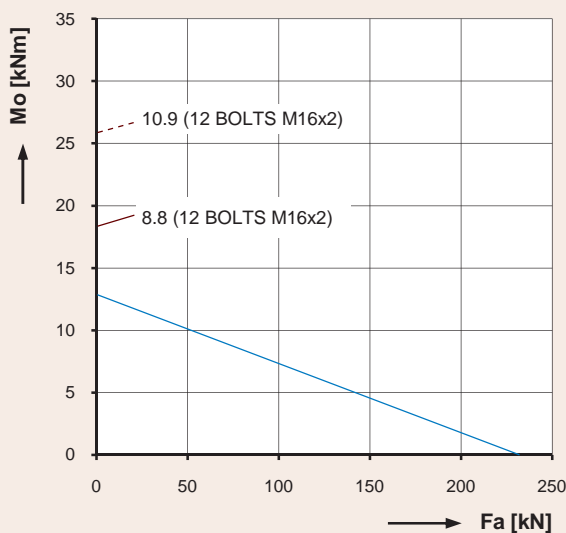

9O-1Z14-0222-1026-1

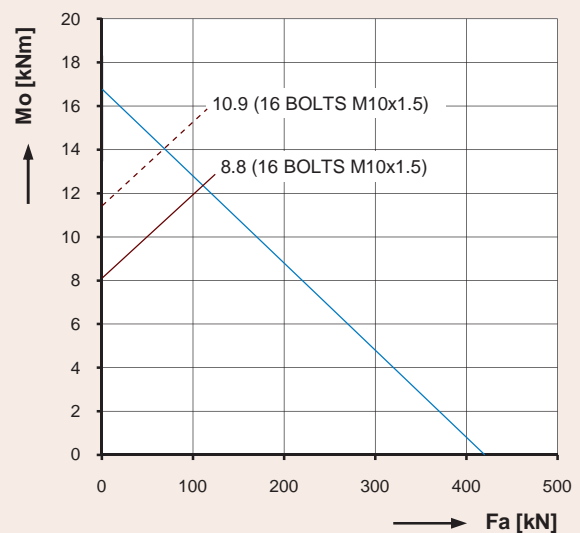

9E-1B14-0188-1029

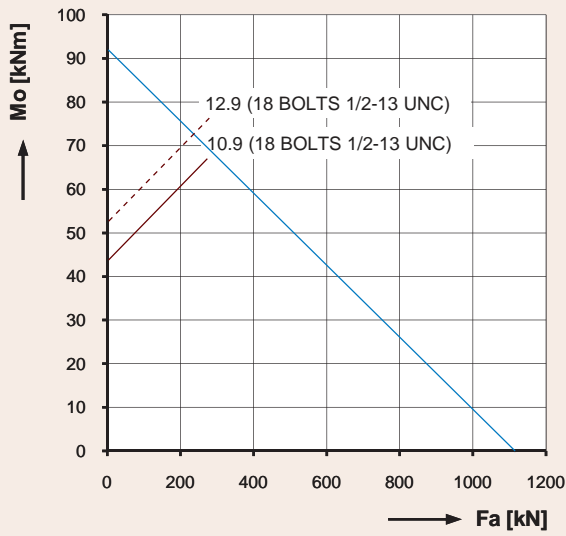

9I-1B20-0388-1034

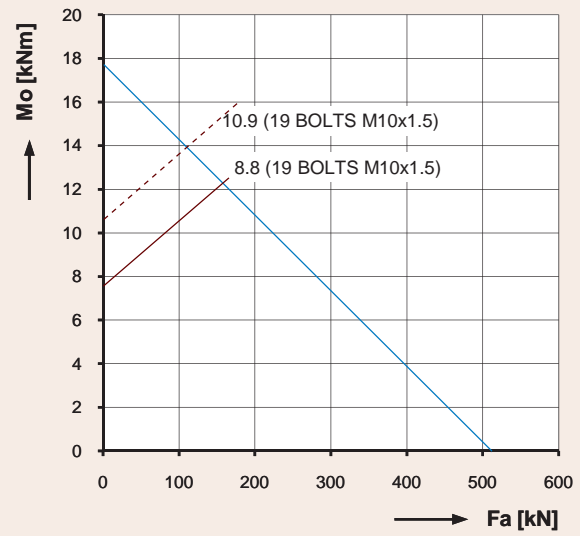

9O-1B22-0163-1038

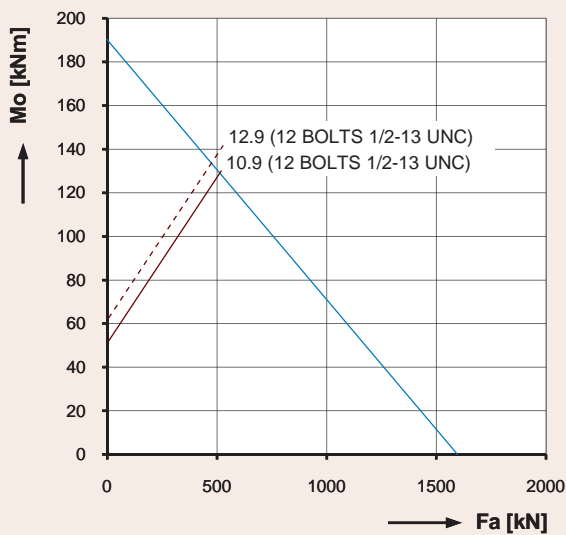

9O-1B20-0560-1039

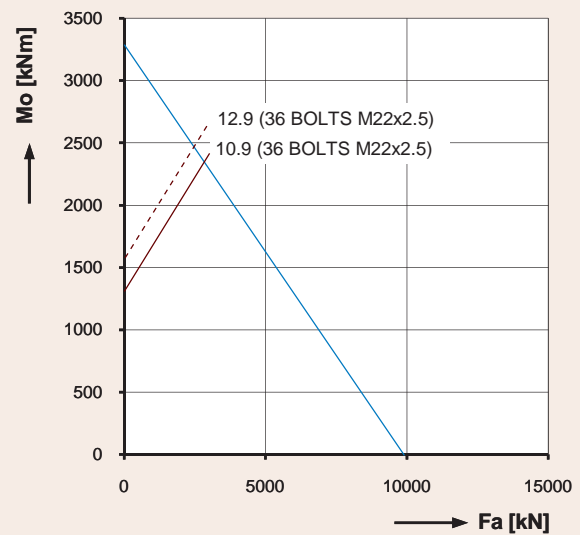

9I-1B45-1561-1040

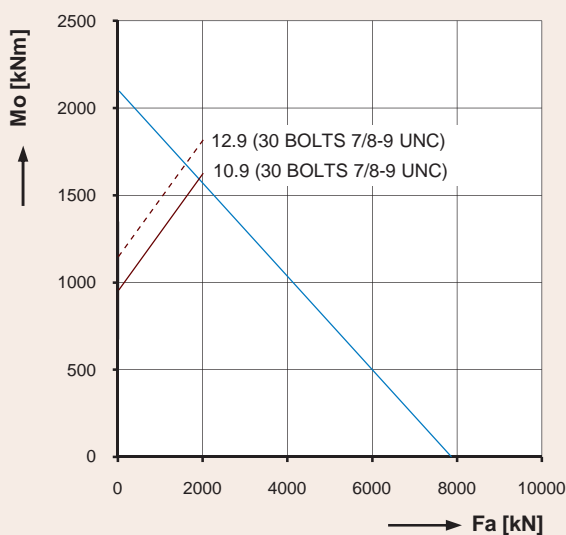

9I-1B45-1257-1041

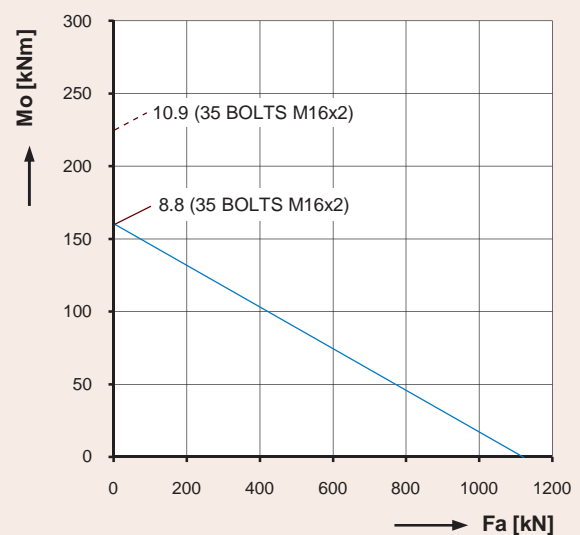

9E-1Z25-0575-1044

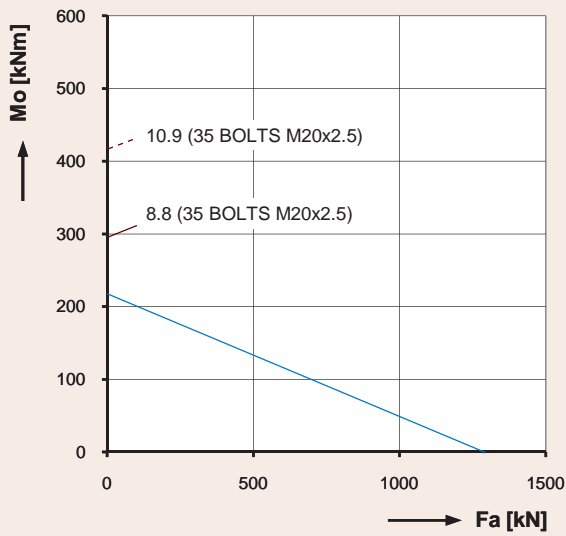

9E-1Z25-0675-1045

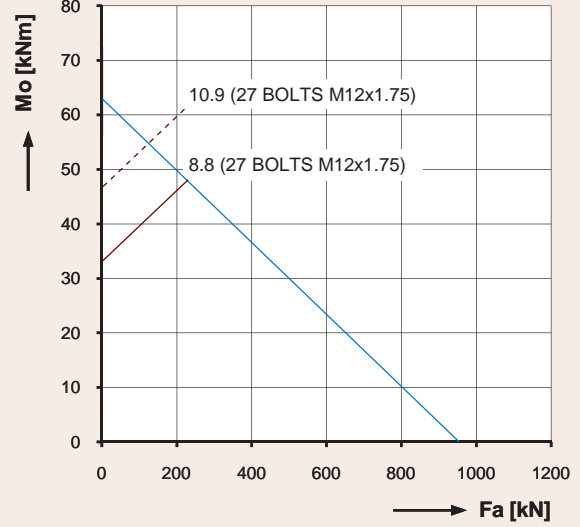

9O-1B22-0311-1049

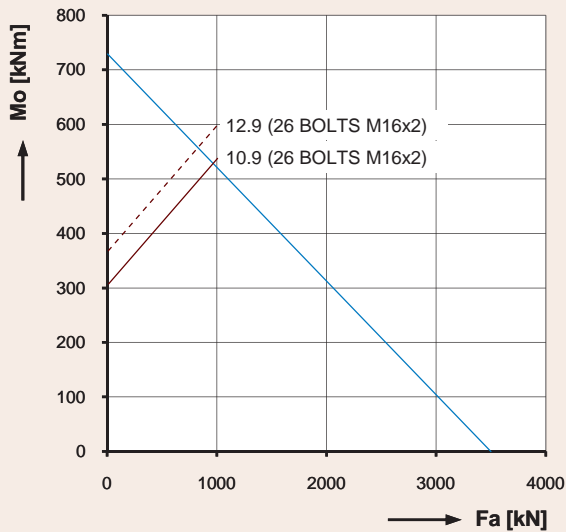

9I-1B25-0980-1052

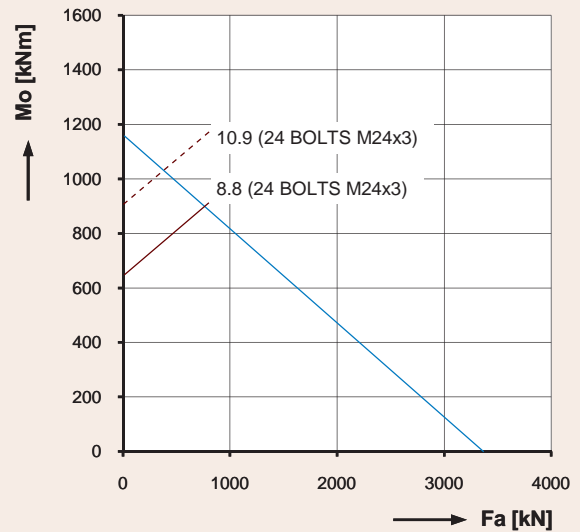

9I-1Z30-1380-1053

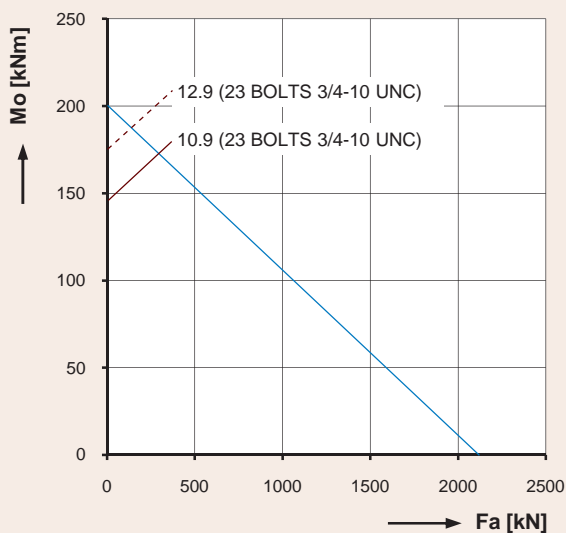

9E-1B35-0445-1057

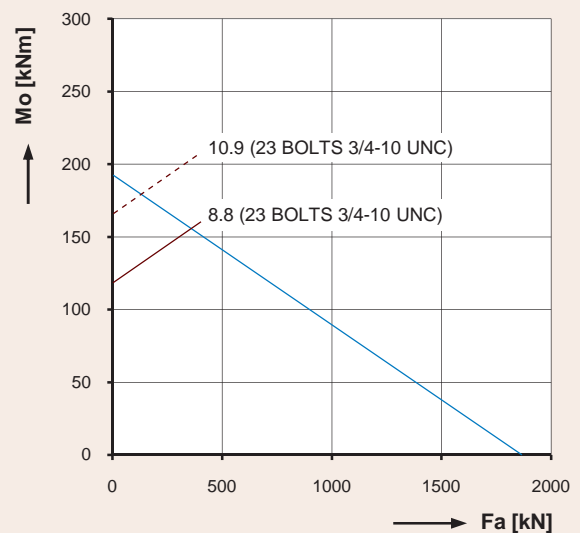

9E-1B25-0486-1063

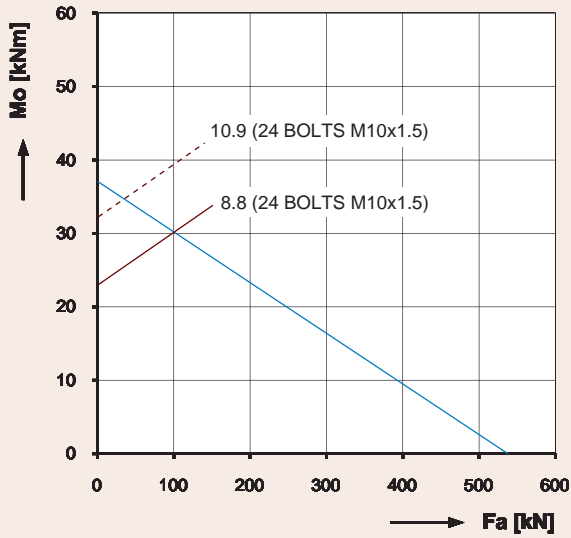

9O-1B14-0325-1067

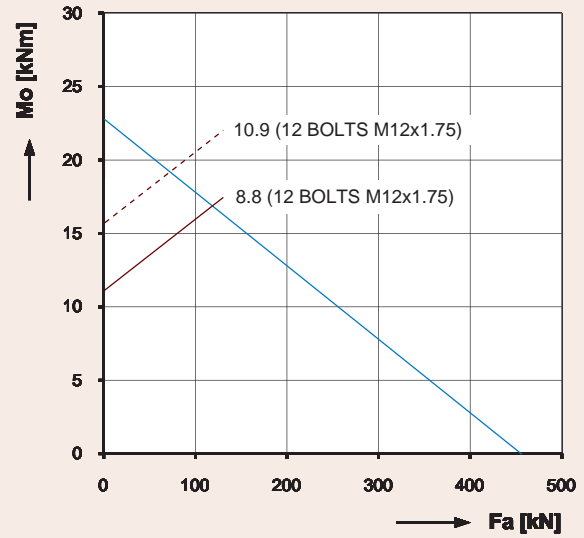

9E-1B16-0235-1070

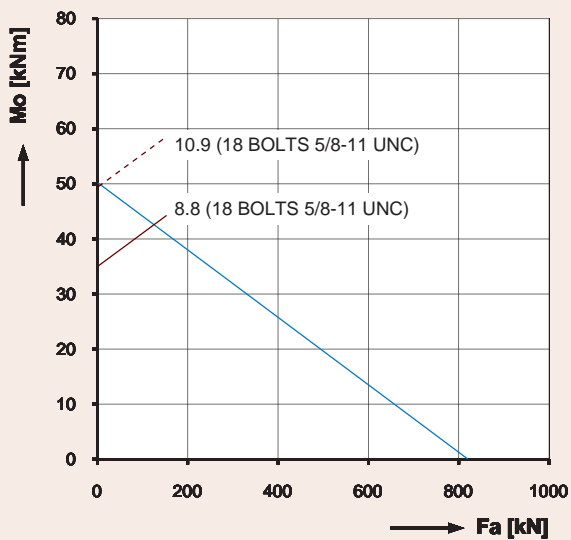

9E-1B20-0288-1072

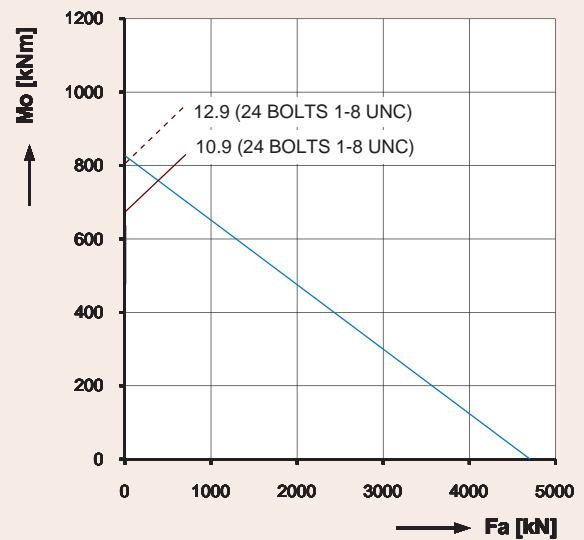

9I-1B35-0825-1077

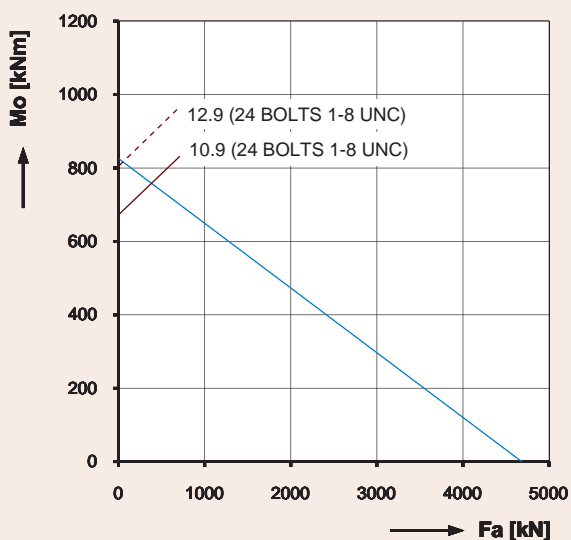

9I-1B35-0825-1077-1

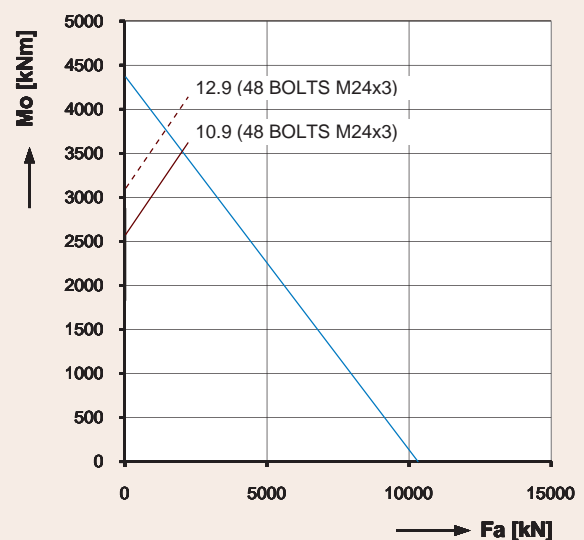

9I-2B30-1995-1085

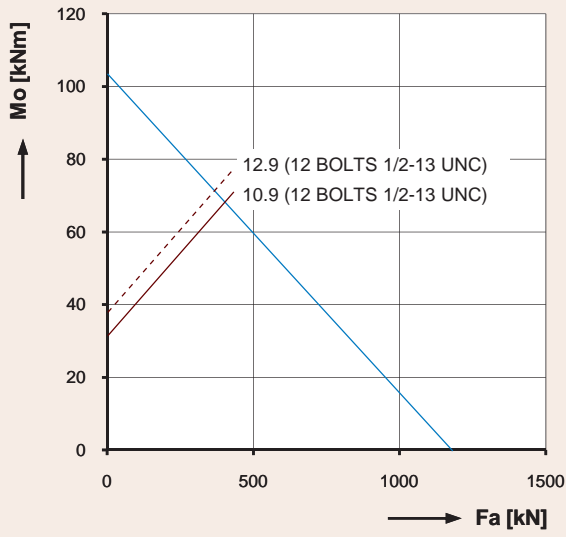

9O-1B20-0414-1087

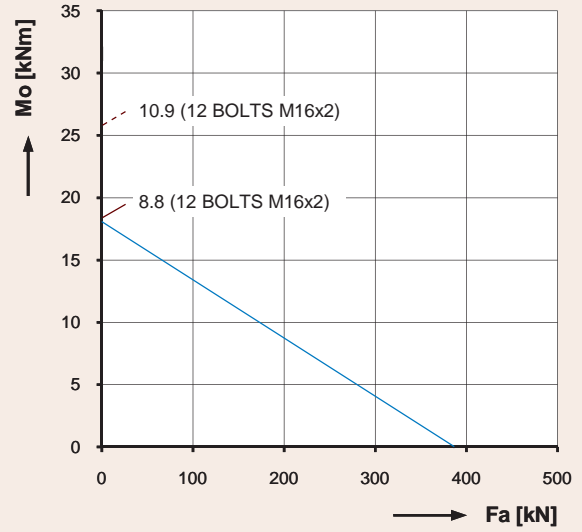

9O-1B13-0220-1092

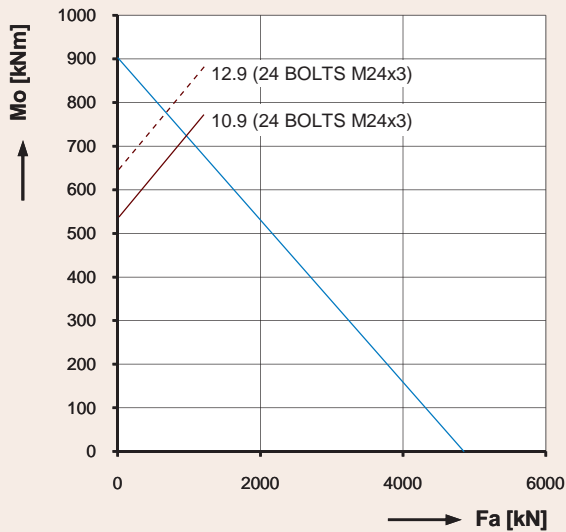

9E-1B40-0876-1105

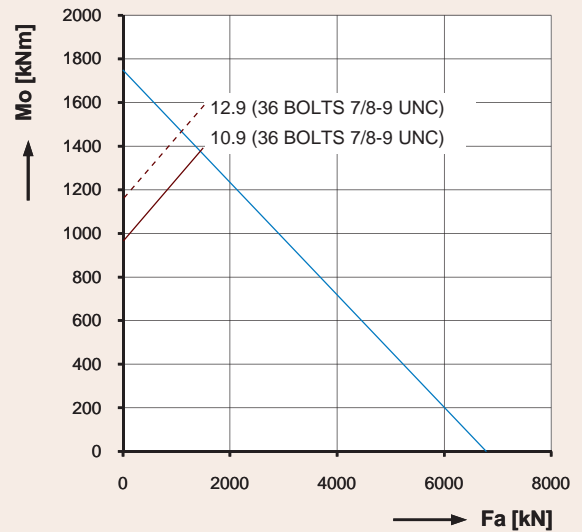

9E-1B40-1213-1108

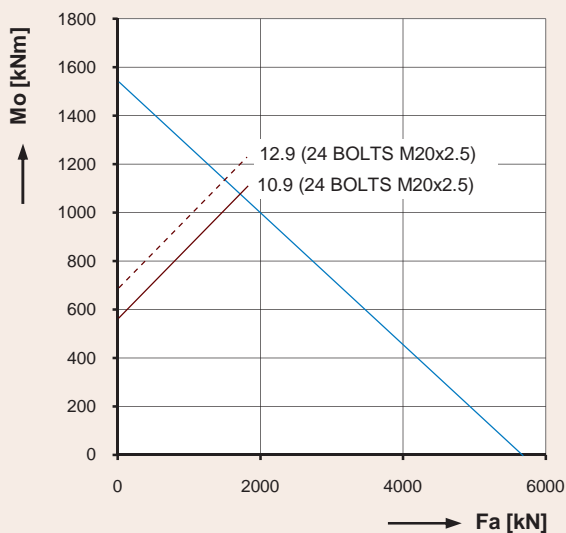

9I-1B30-1280-1109

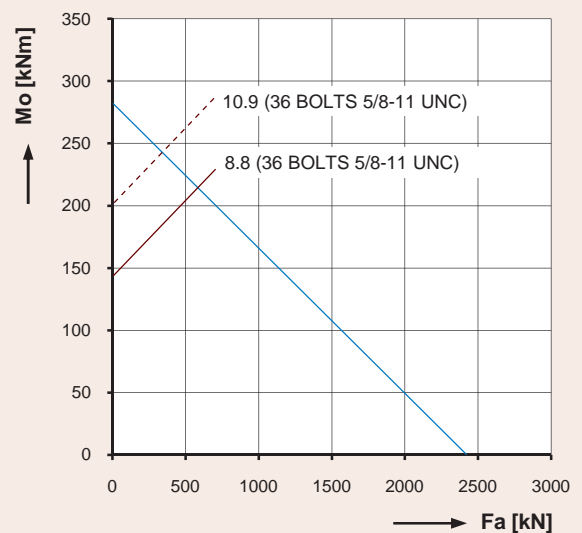

9E-1B32-0548-1110



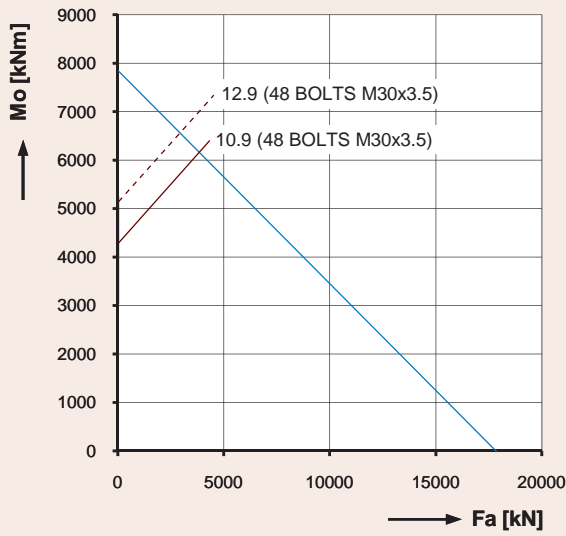

9I-1B50-2070-1111

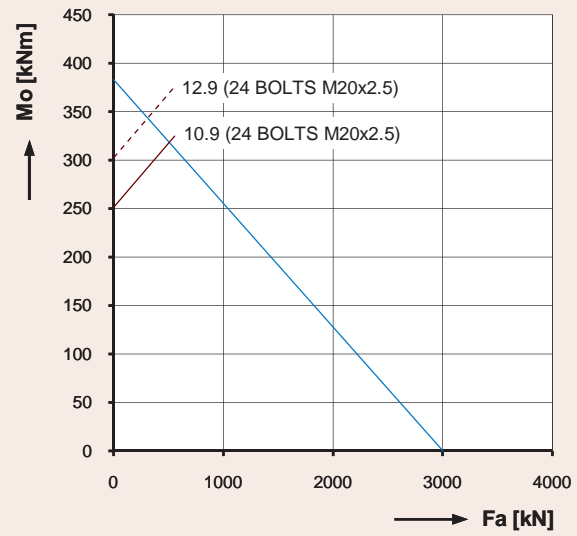

9O-1B30-0600-1113

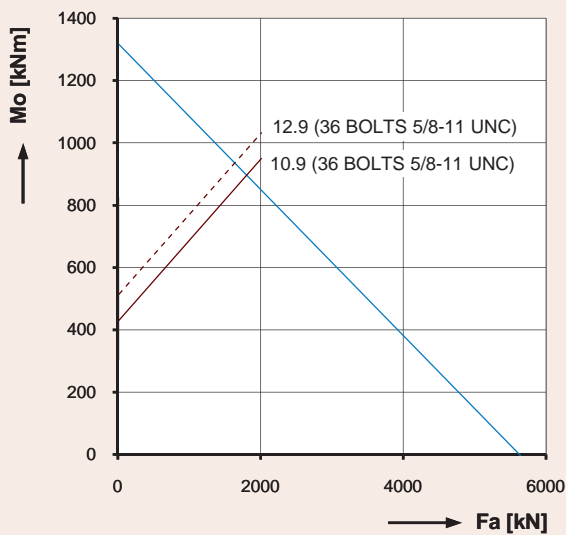

9I-1B30-1099-1114

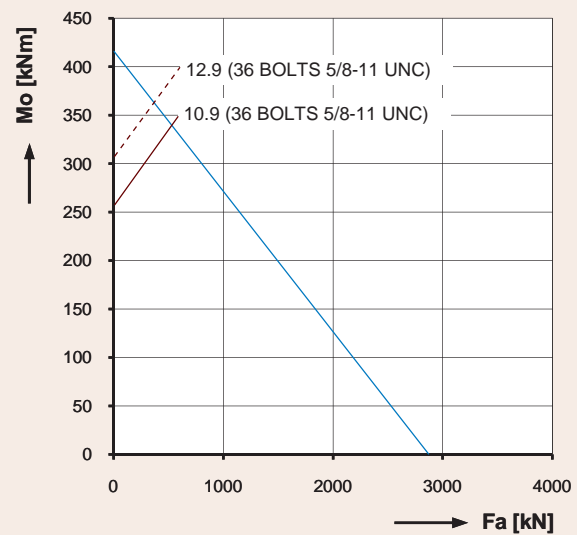

9I-1B25-0682-1115

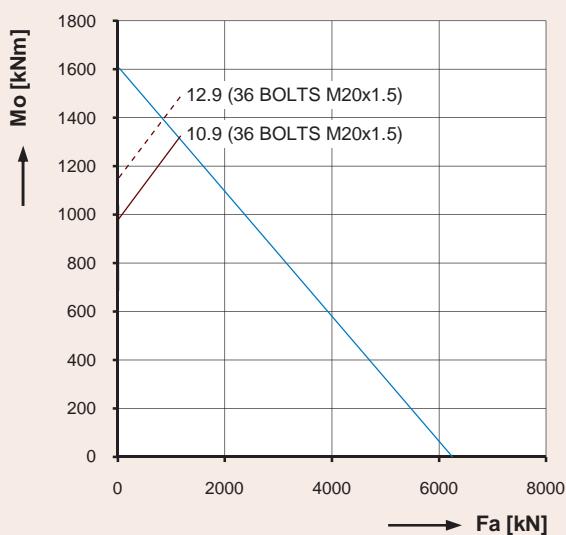

9I-1B30-1212-1116

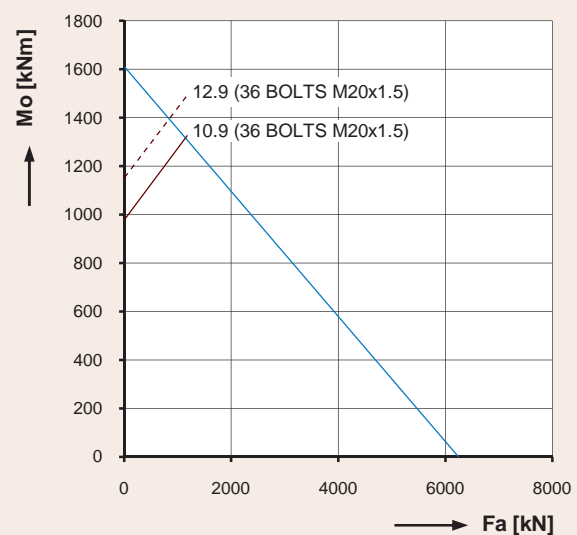

9I-1B30-1212-1117

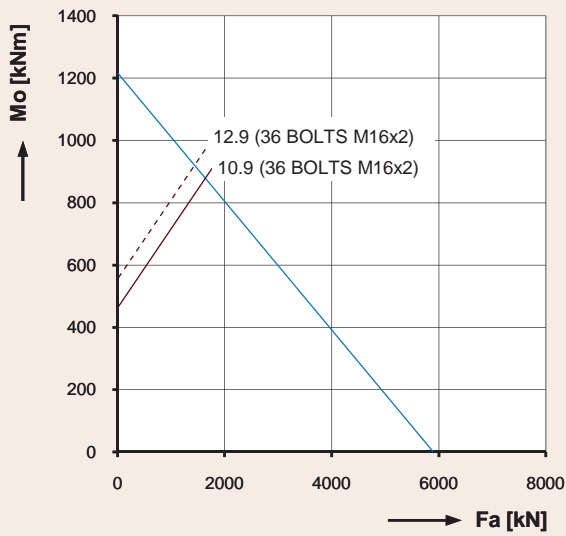

9E-2B20-0970-1121

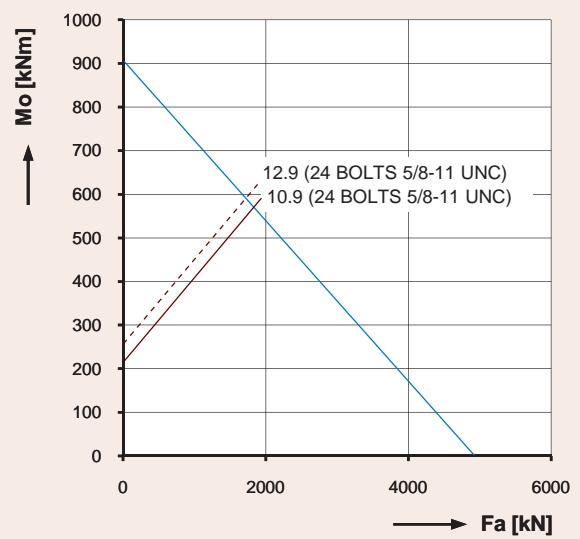

9O-1B35-0867-1122

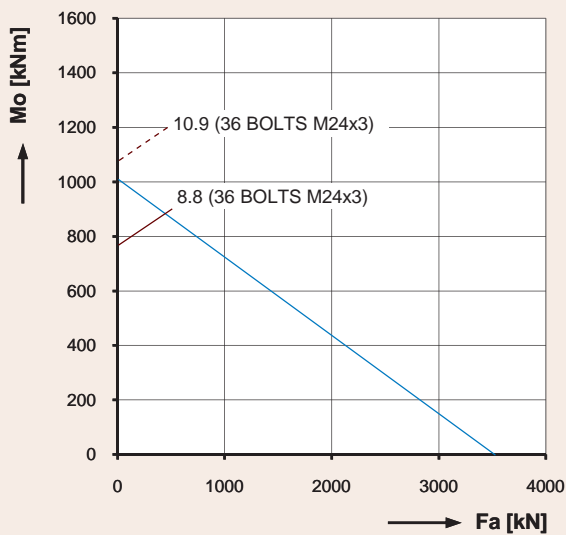

9I-1Z40-1150-1123

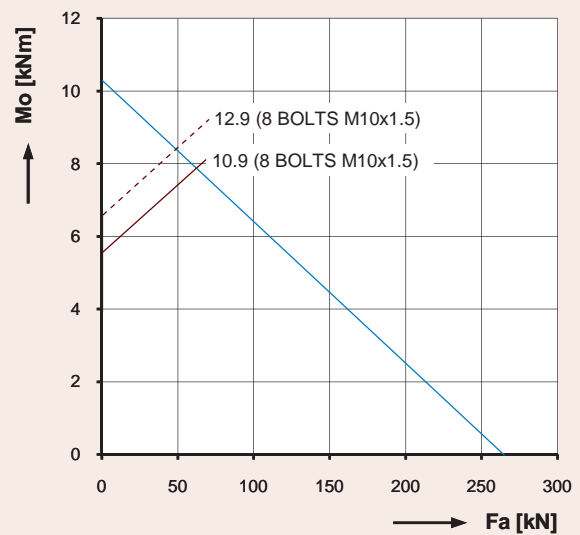

9O-1B17-0183-1125

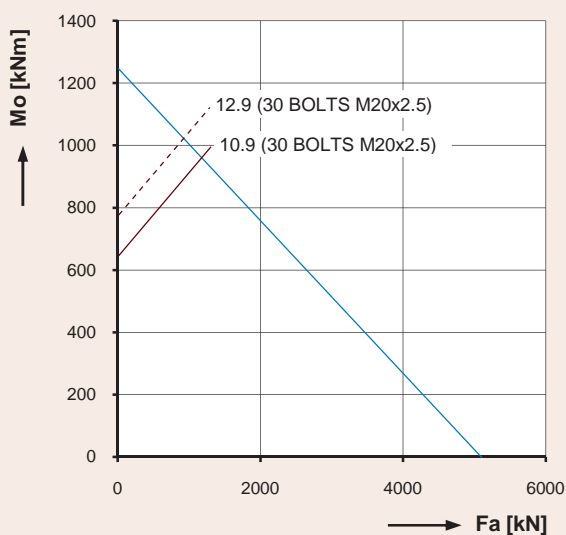

9I-1B30-1150-1126

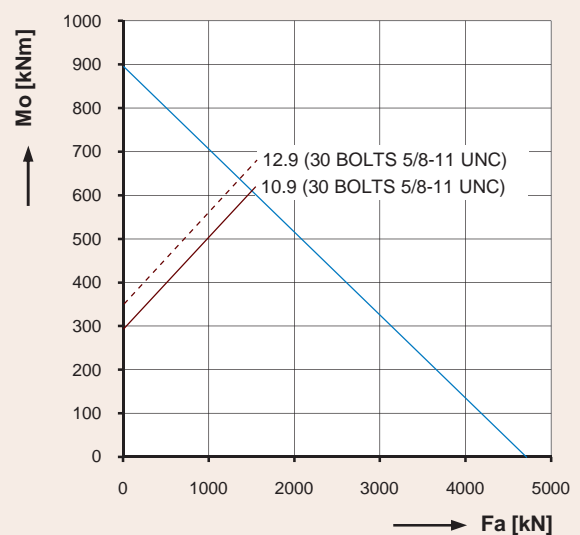

9I-2B20-0896-1129

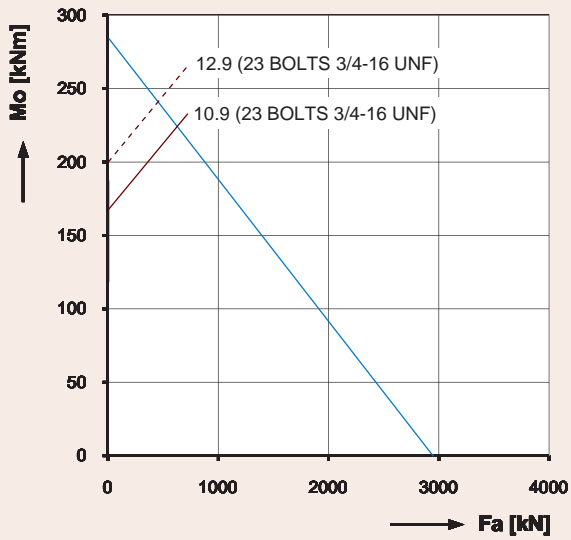

9E-1B45-0453-1132

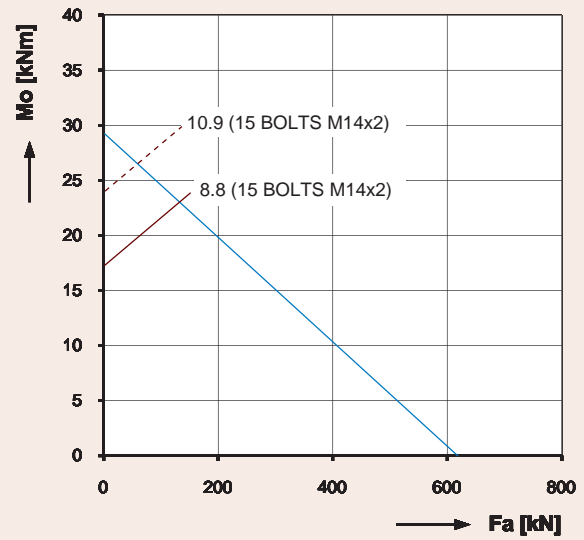

9E-1B20-0223-1140

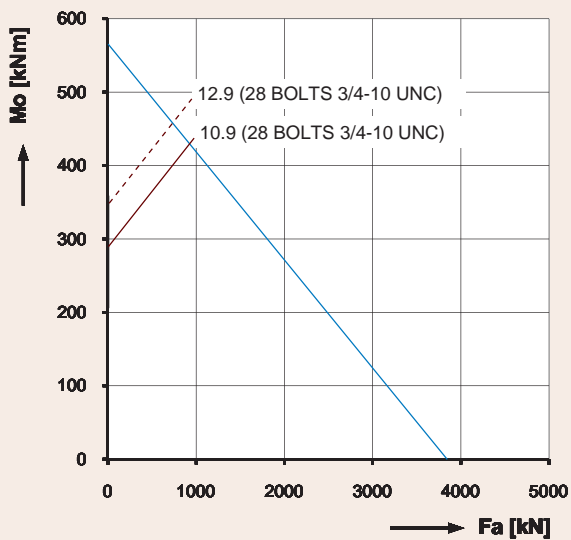

9E-1B40-0691-1149

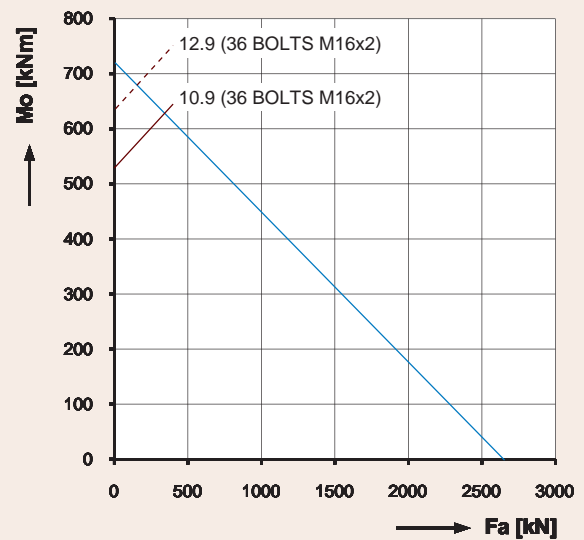

9I-1Z30-1090-1151

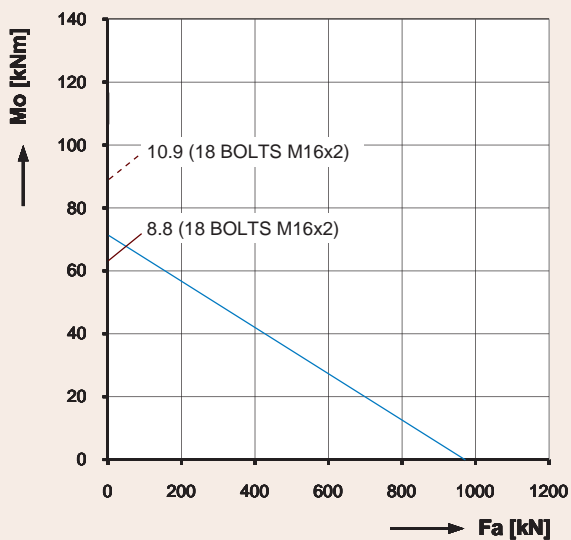

9E-1B20-0345-1153

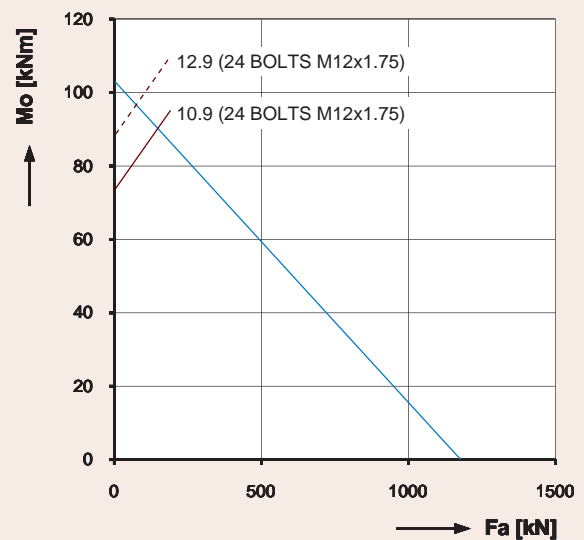

9E-1B20-0411-1161

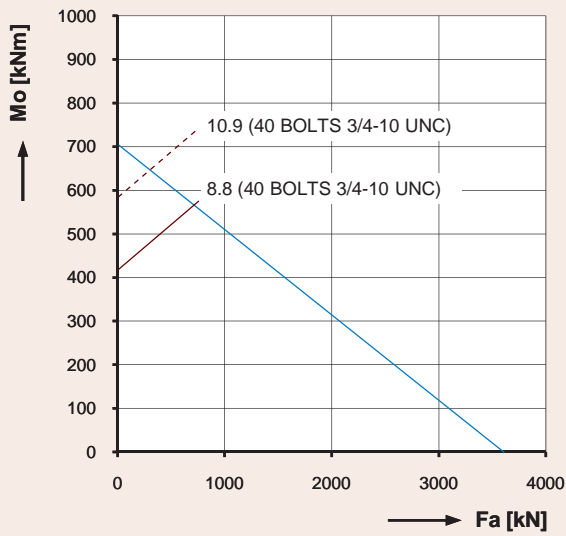

9E-1B25-0920-1162

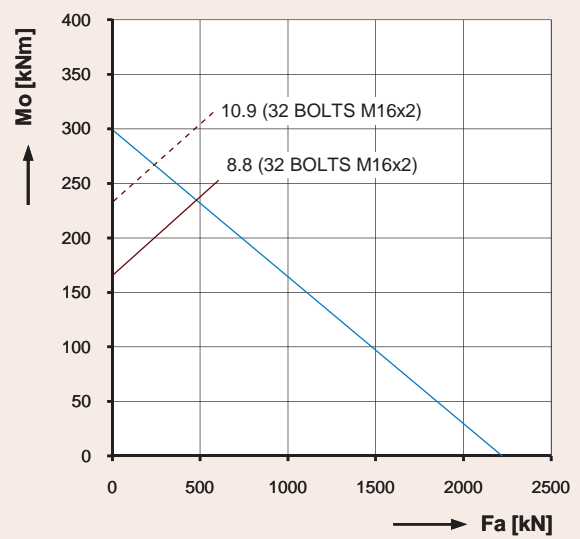

9I-1B25-0632-1164

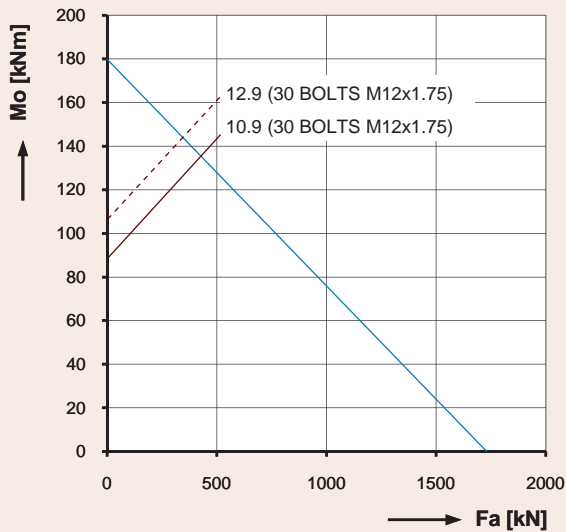

9I-1B25-0489-1165

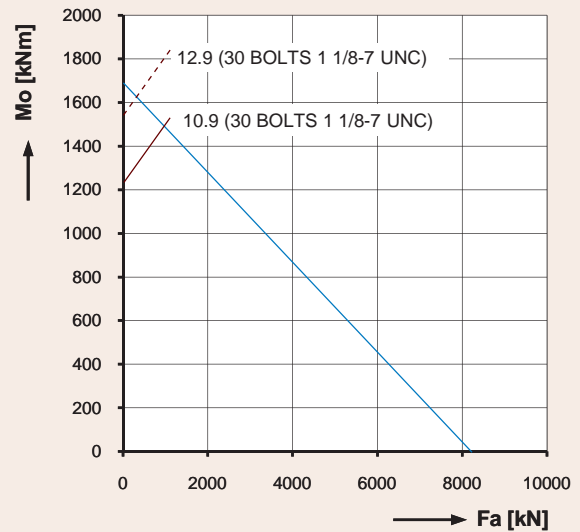

9I-1B50-0970-1166

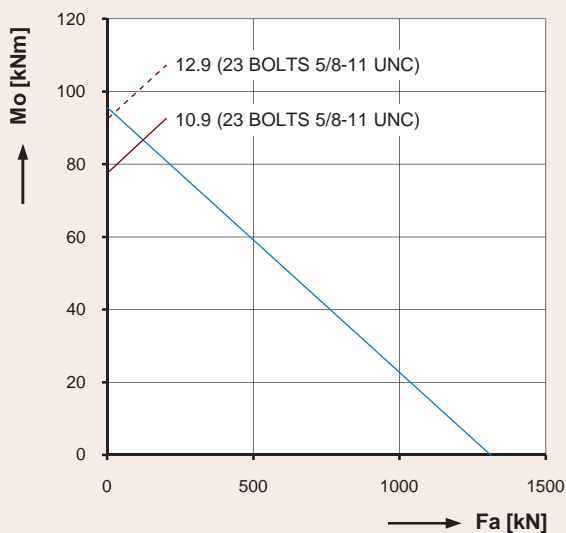

9E-1B22-0343-1167

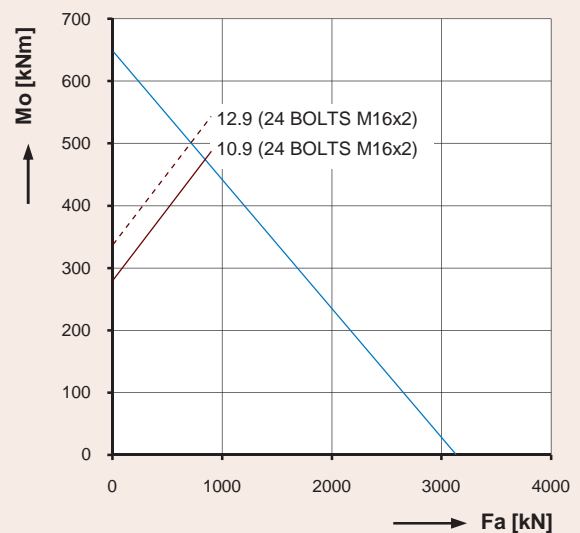

9E-1B22-0975-1173

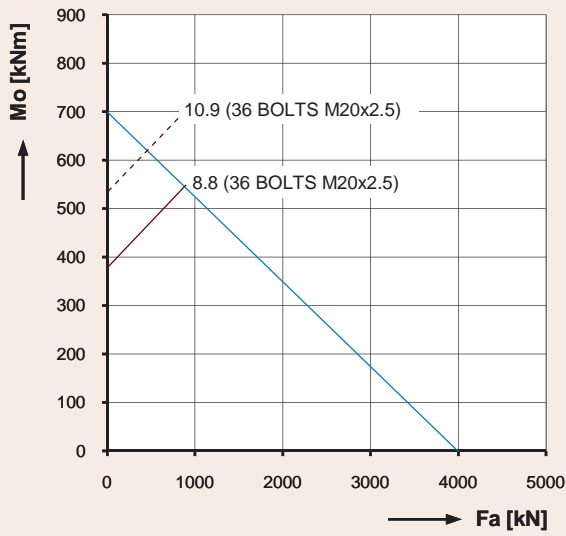

9E-1B35-0823-1175

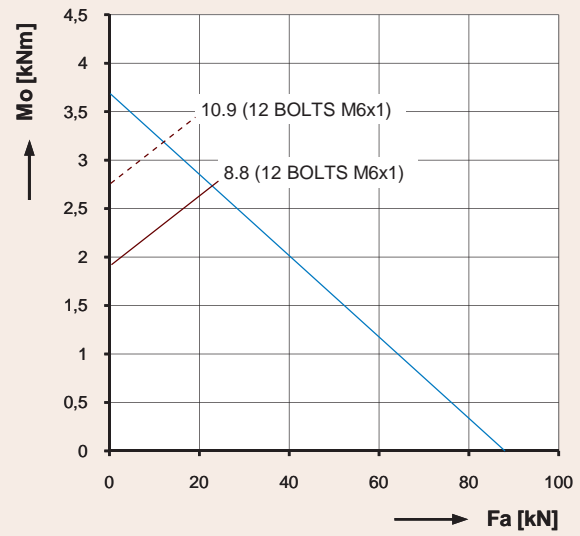

9O-1Z08-0168-1178

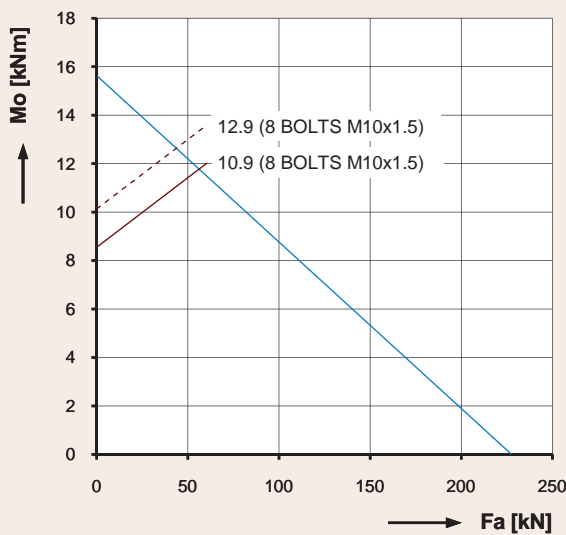

9O-1Z12-0275-1180

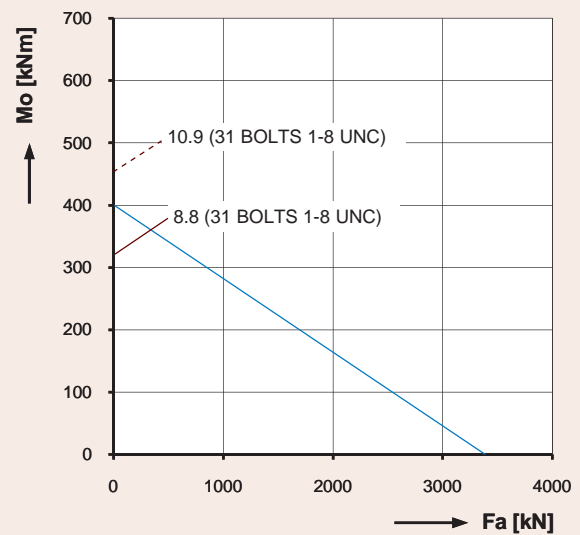

9E-1B45-0557-1184

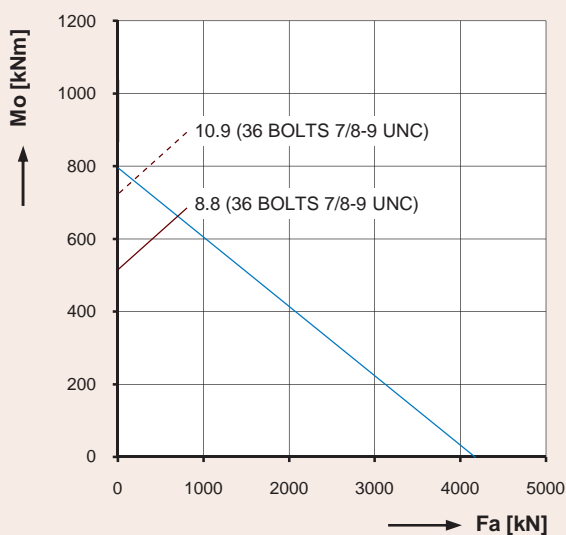

9I-1B32-0897-1185

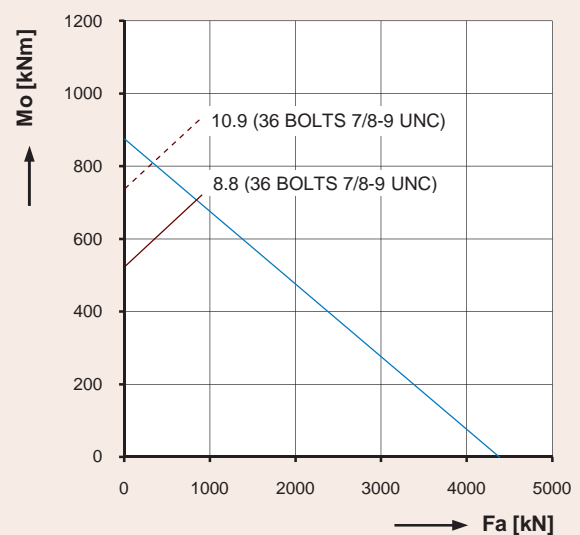

9E-1B32-0940-1186

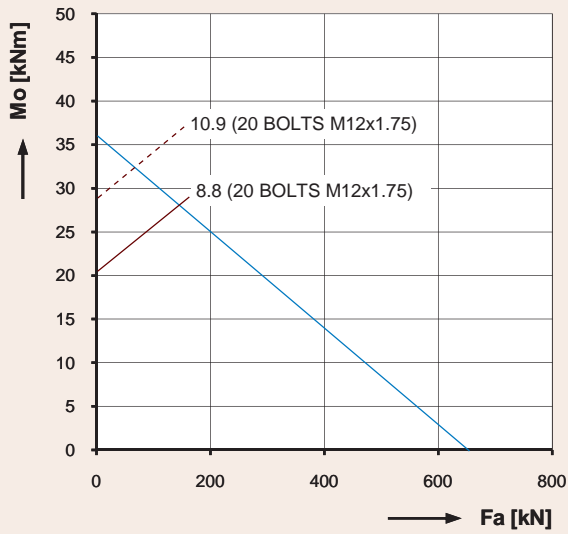

9O-1B20-0260-1187

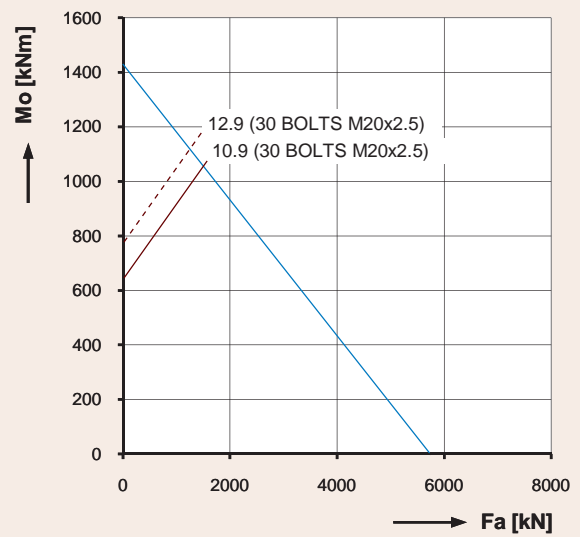

9I-1B35-1170-1190

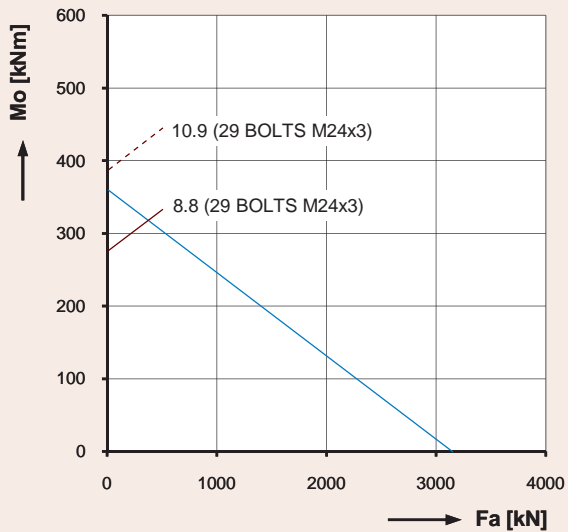

9E-2B25-0539-1191

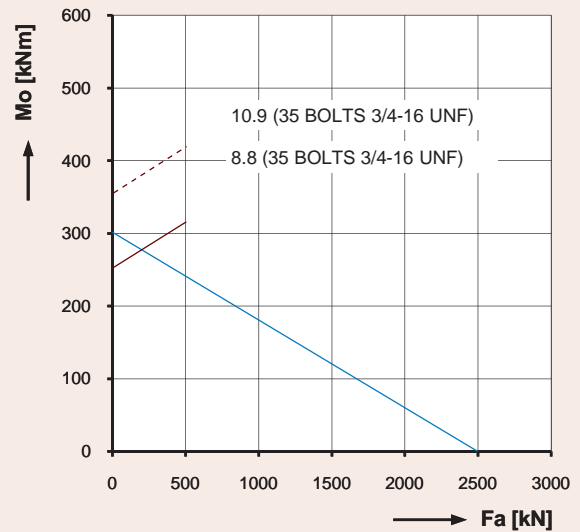

9E-1B25-0569-1193

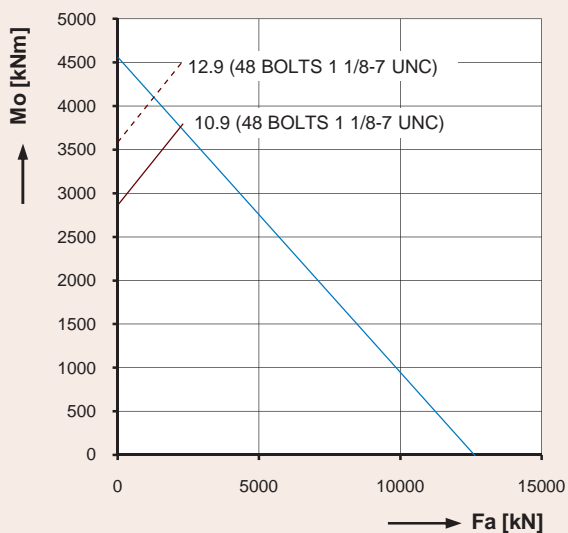

9E-1B50-1700-1195

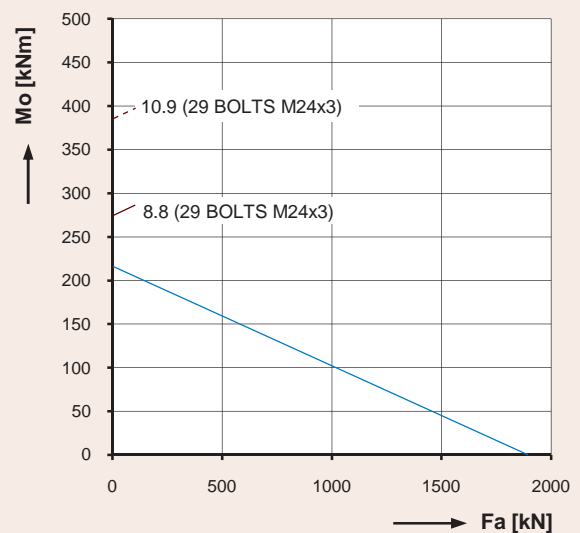

9E-1B25-0537-1196

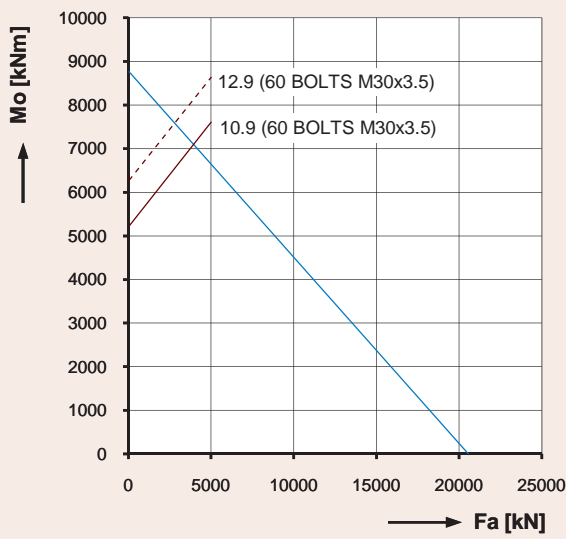

9E-2B40-2010-1197

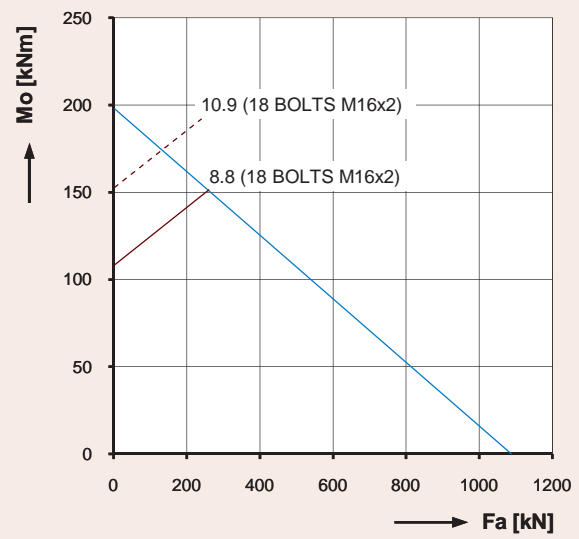

9E-1Z20-0730-1198

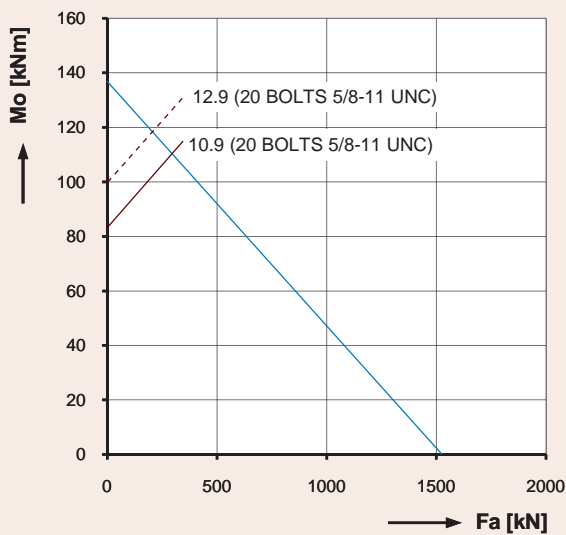

9O-1B25-0422-1200

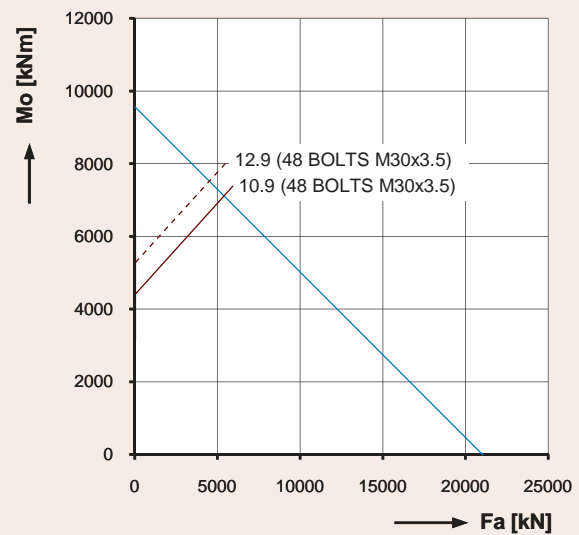

9E-1B60-2140-1204

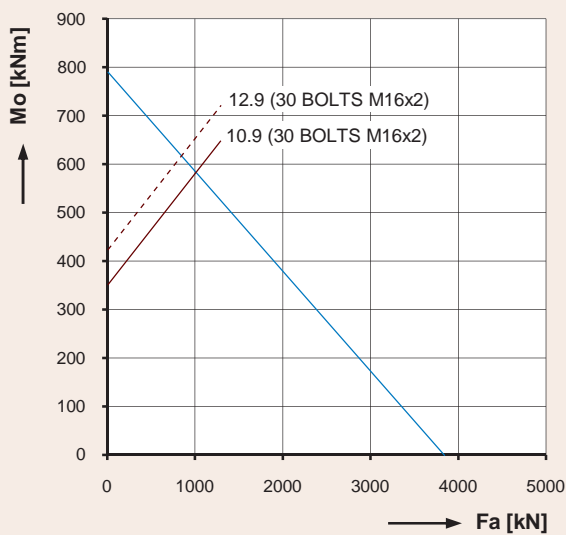

9E-1B25-0969-1205

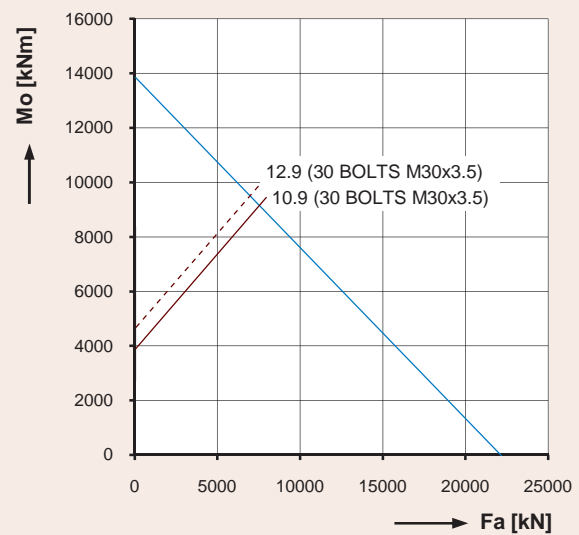

9E-1B50-2944-1211

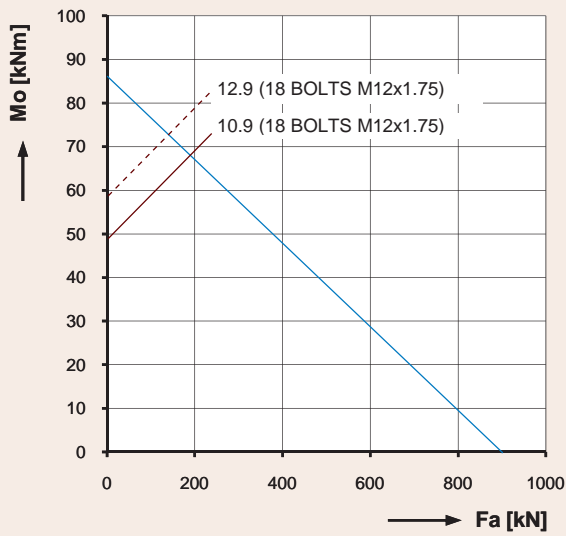

9E-1B16-0451-1212

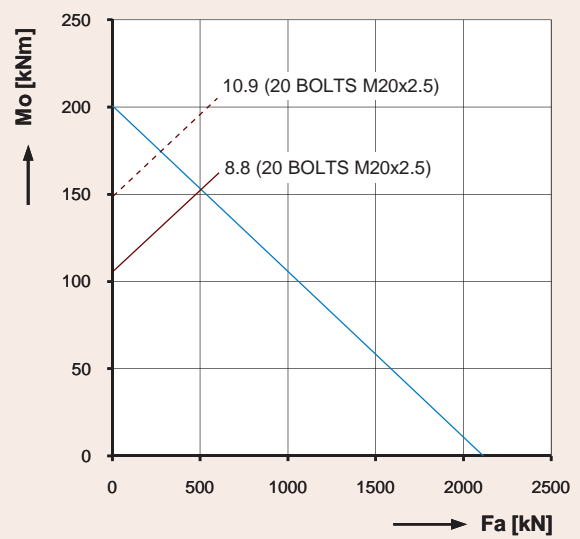

9O-1B30-0446-1217

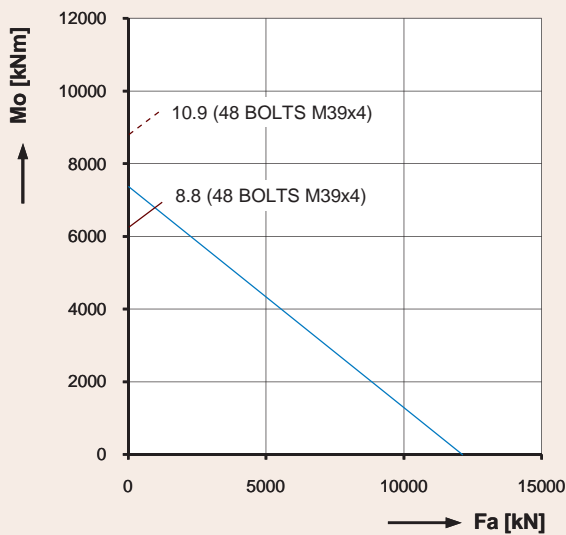

9I-1Z60-2435-1218

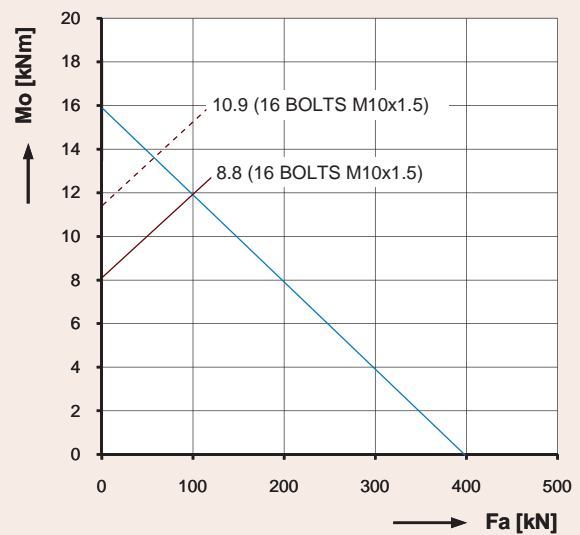

9E-1B13-0188-1219

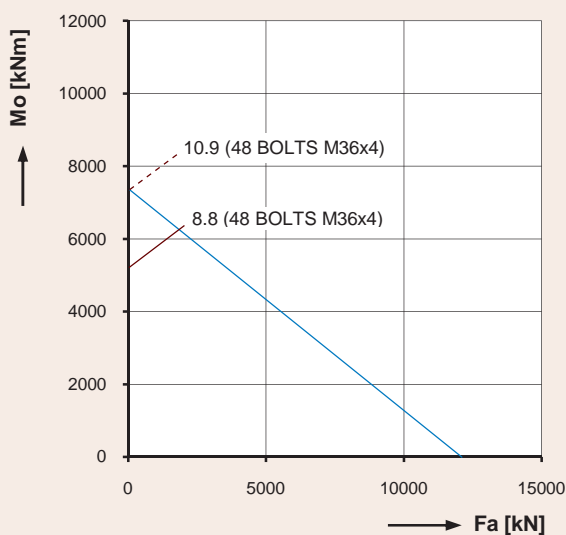

9I-1Z60-2435-1221

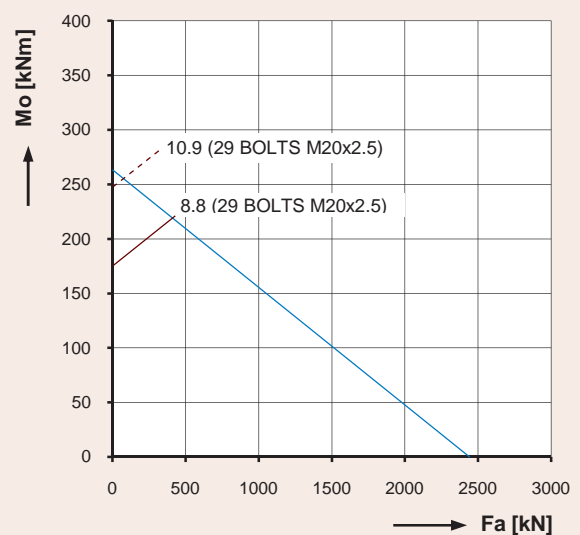

9E-1B35-0508-1227



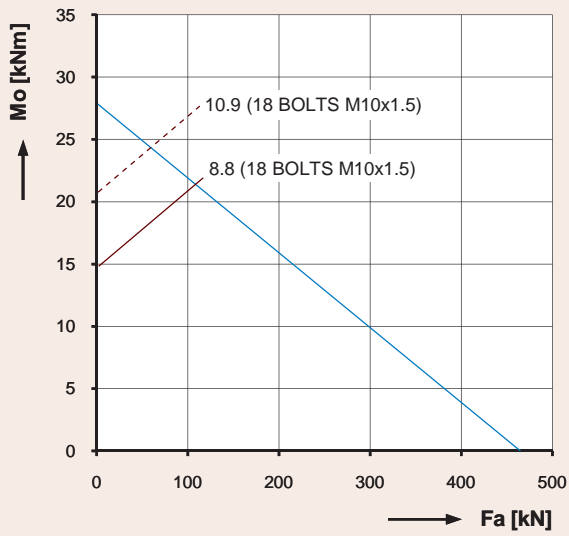

9E-1B14-0282-1231

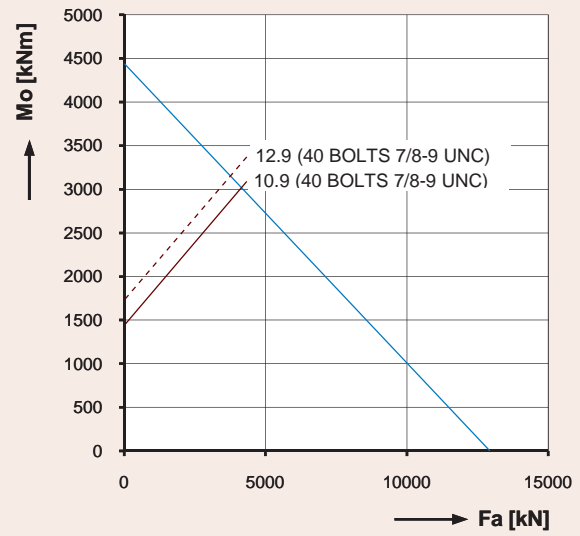

9I-2B30-1615-1234

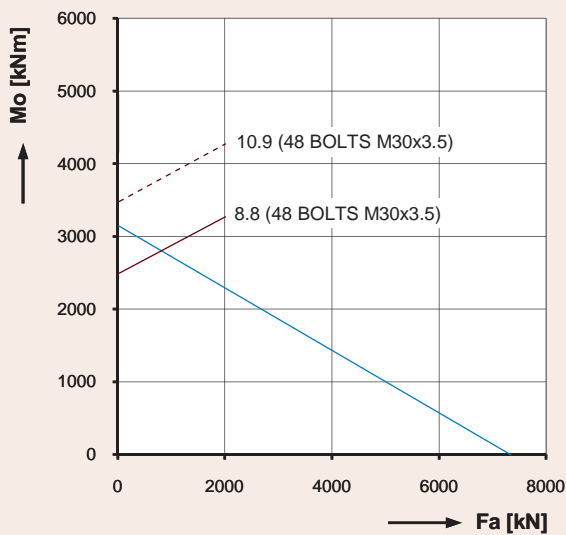

9E-1Z50-1722-1238

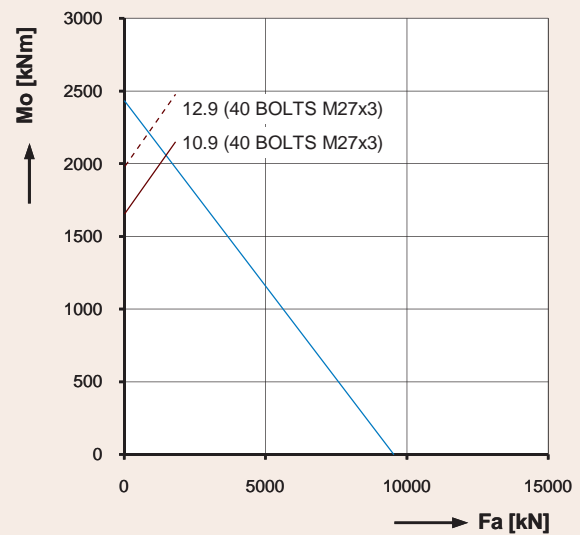

9O-1B50-1200-1239

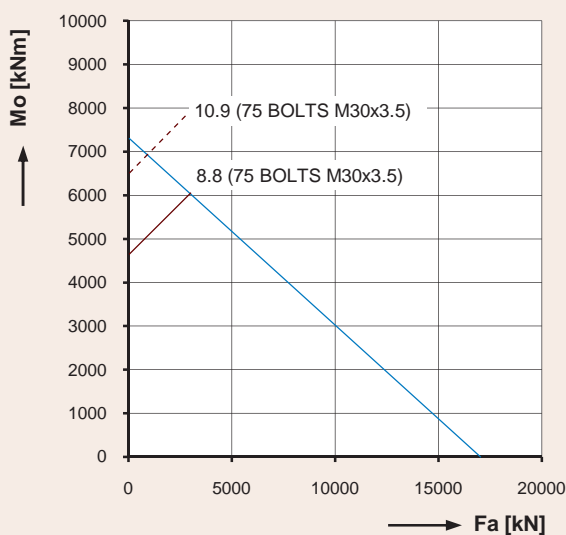

9E-1B60-2020-1240

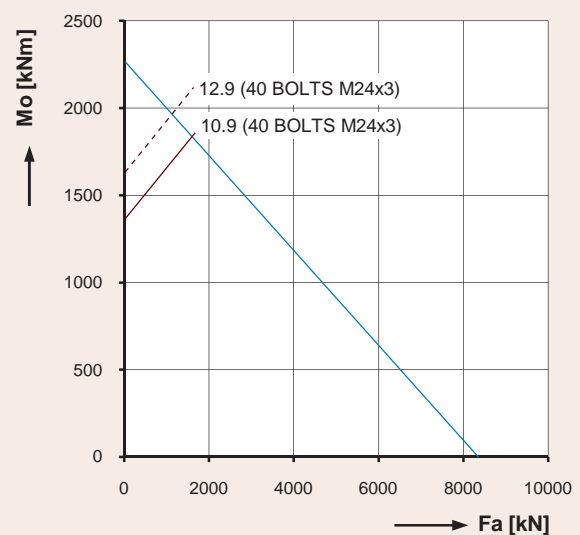

9E-1B40-1278-1244

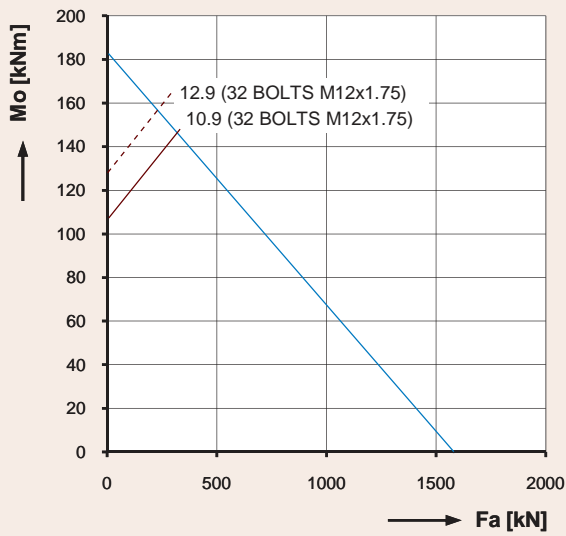

9E-1B20-0545-1247

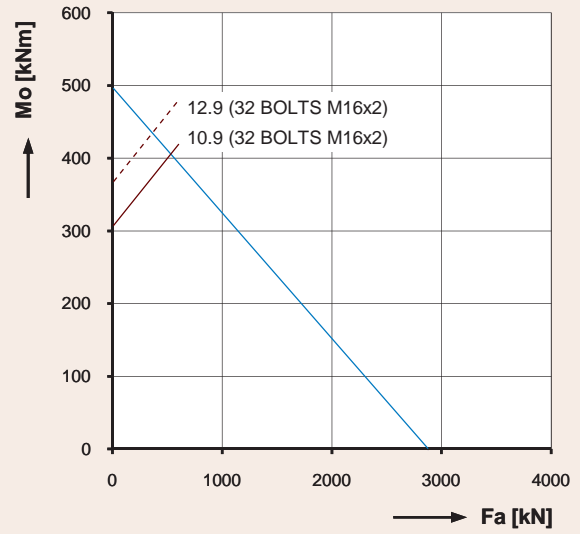

9E-1B25-0812-1249

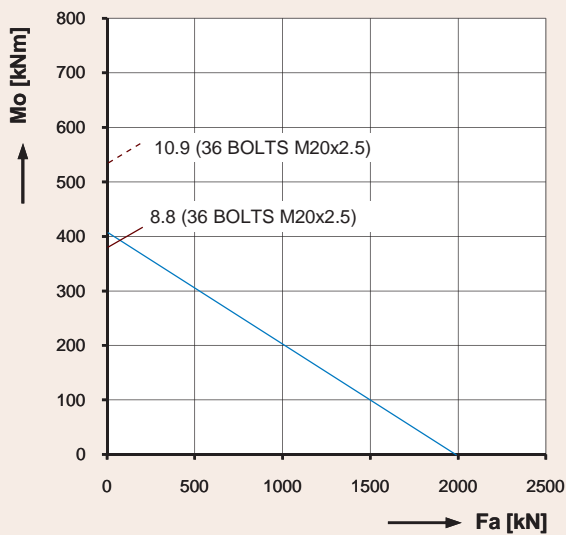

9E-1Z30-0823-1250

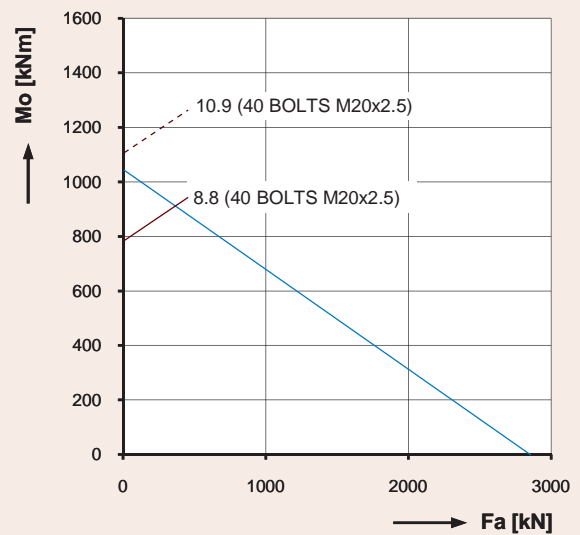

9E-1Z25-1468-1251

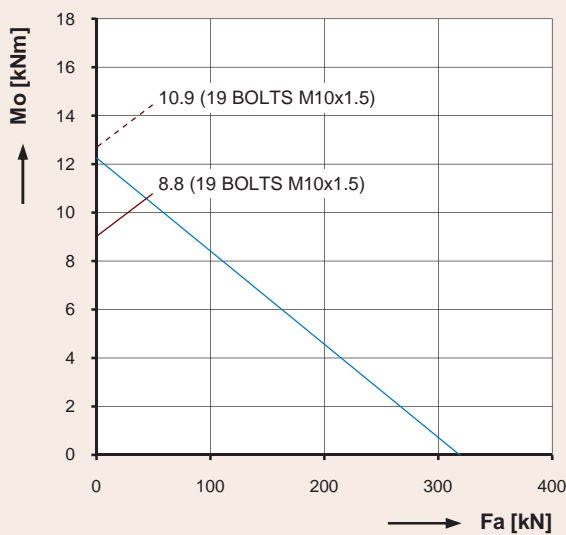

9E-1B13-0181-1262

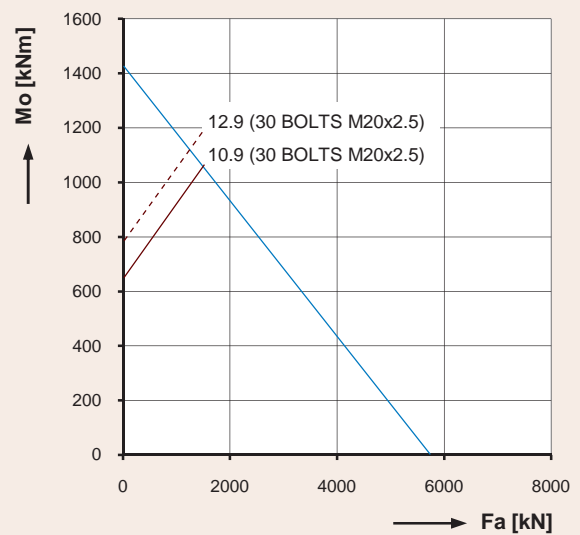

9I-1B35-1170-1266

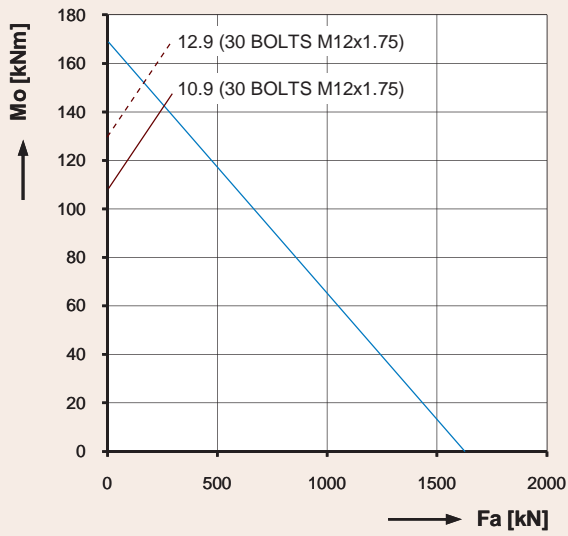

9I-1B22-0489-1267

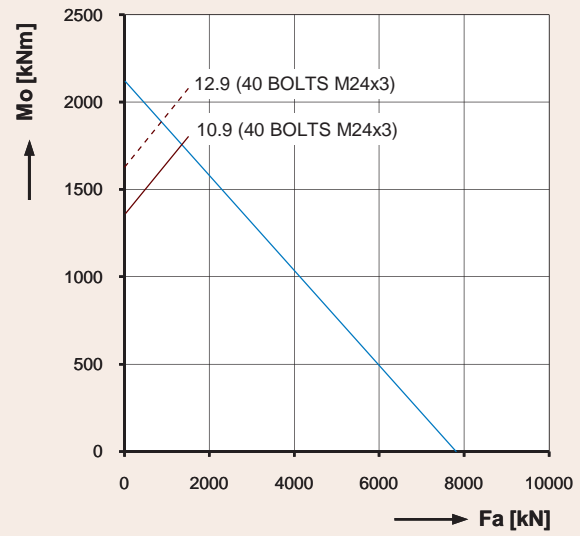

9I-1B40-1278-1269

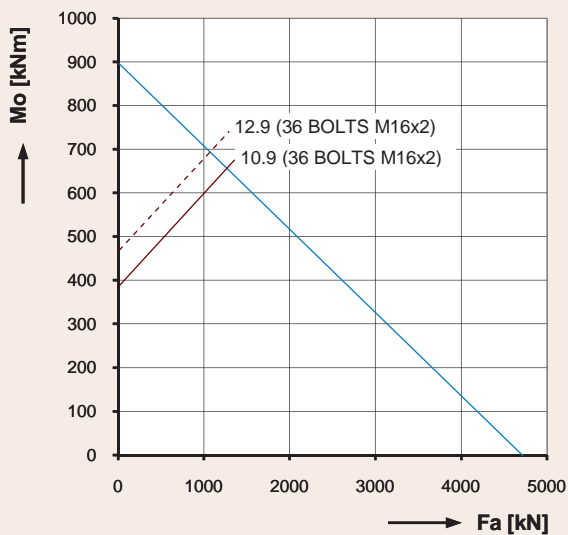

9I-2B20-0897-1277

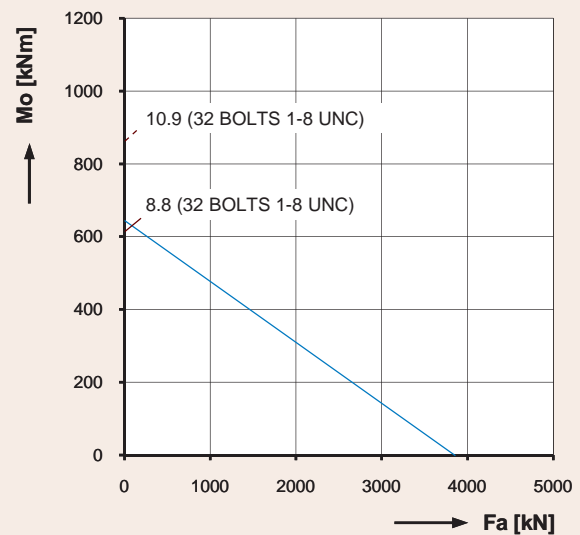

9I-1B32-0788-1283

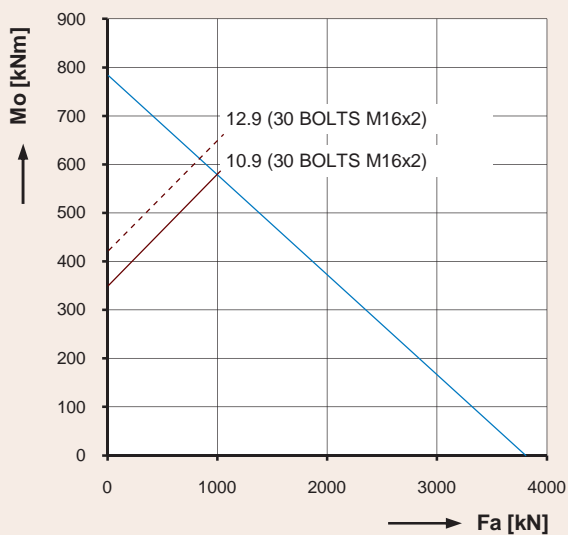

9E-1B25-0969-1289

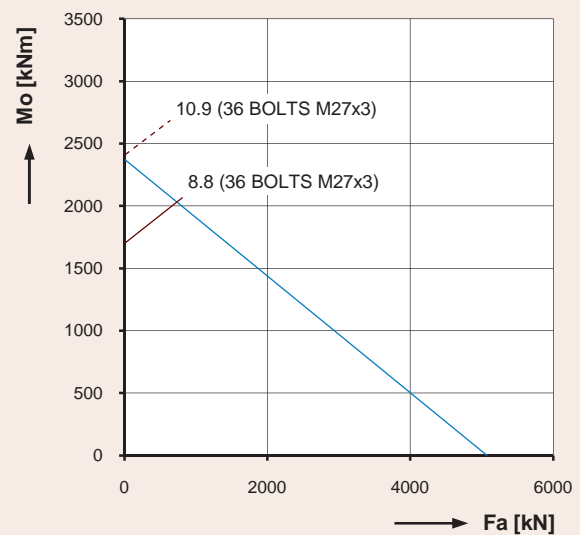

9E-1Z36-1870-1291

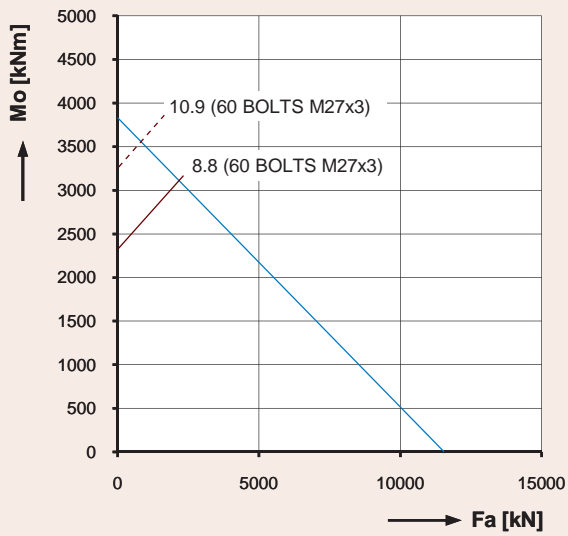

9I-1B50-1559-1297

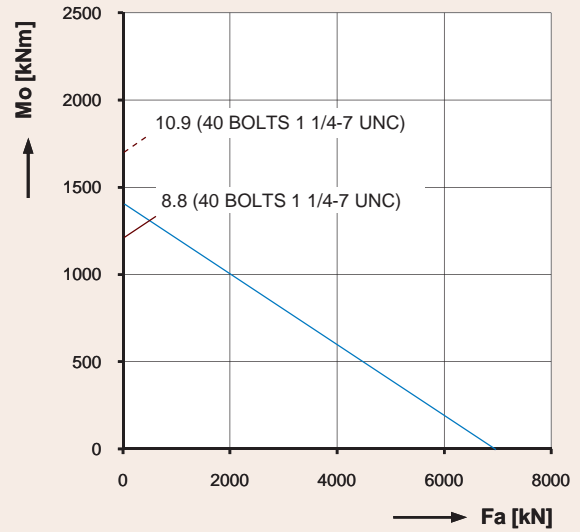

9O-1B50-0953-1299

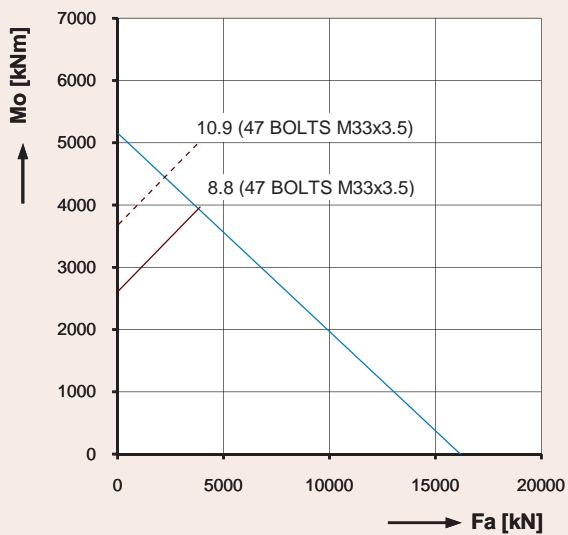

9E-1B60-1495-1300

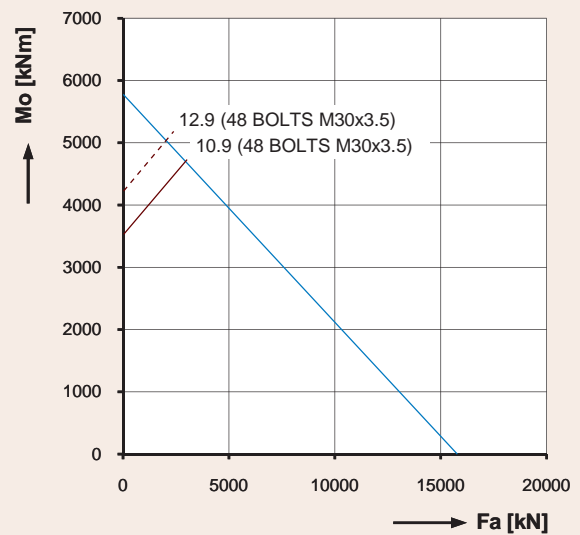

9I-1B50-1722-1311

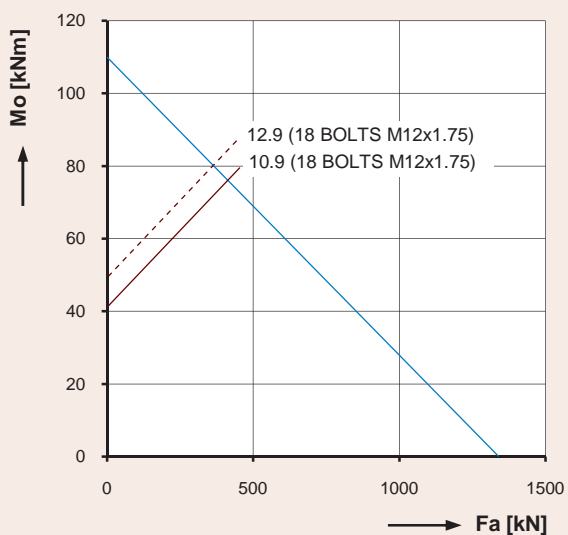

9O-1B20-0386-1320

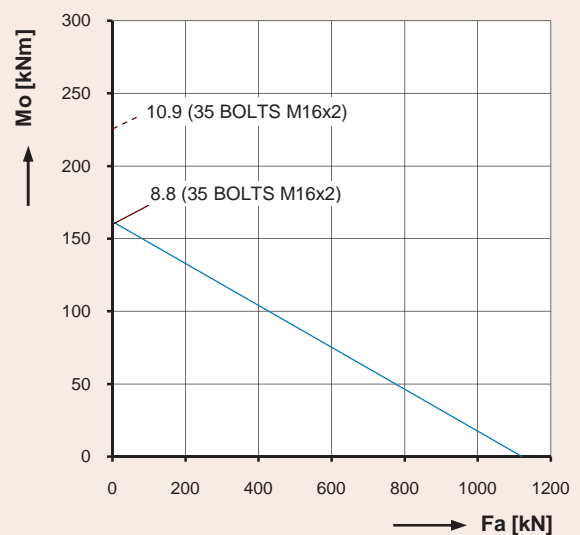

9E-1Z25-0576-1322

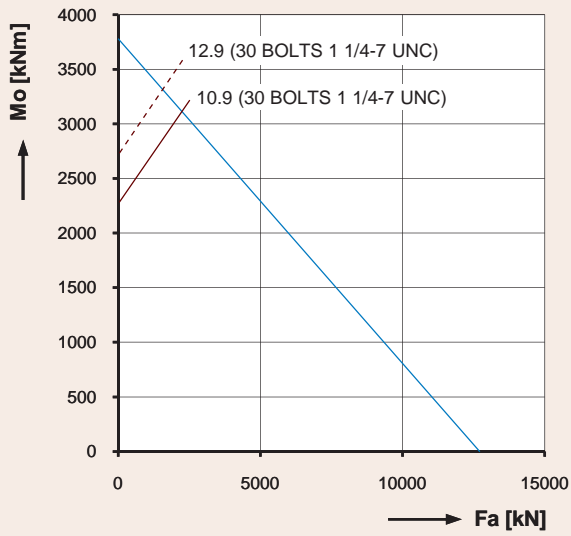

9E-1B50-1399-1332

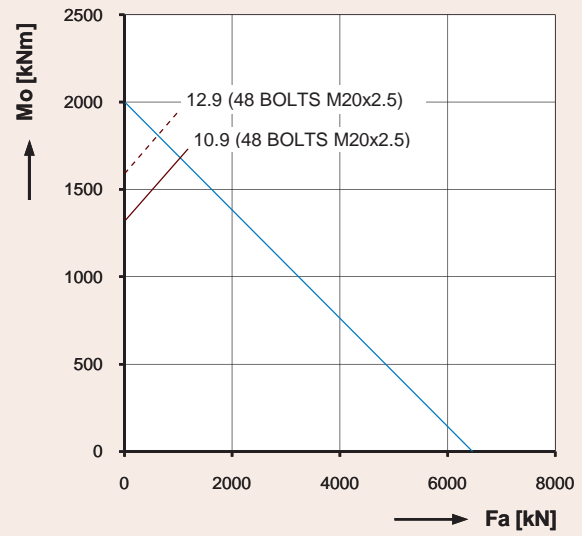

9O-1B25-1455-1334

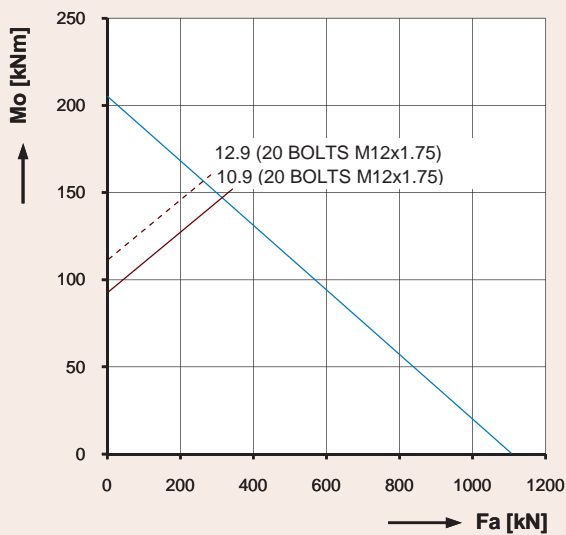

9I-1Z20-0742-1335

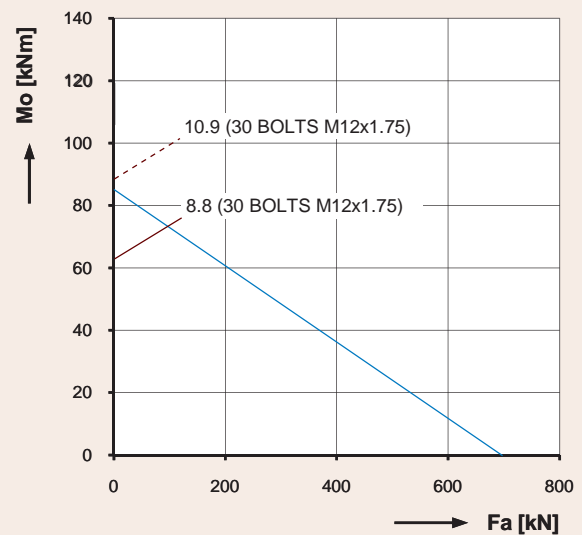

9I-1Z18-0489-1337

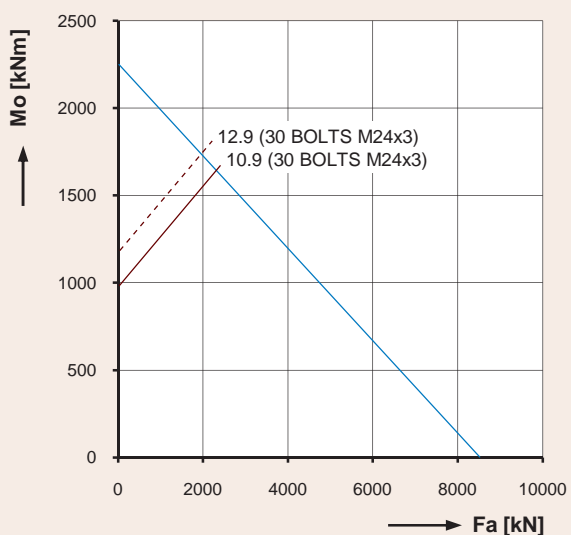

9I-1B40-1241-1341

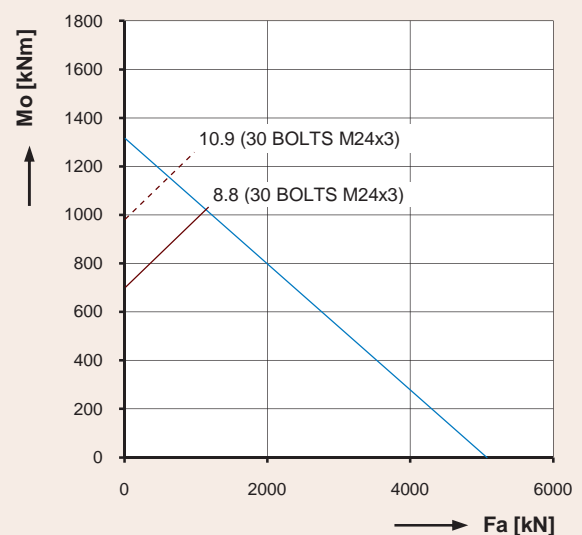

9E-1B22-1220-1342

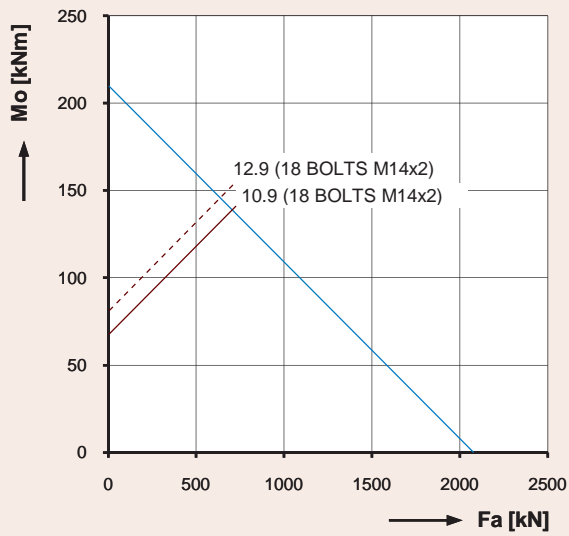

9E-1B25-0475-1345

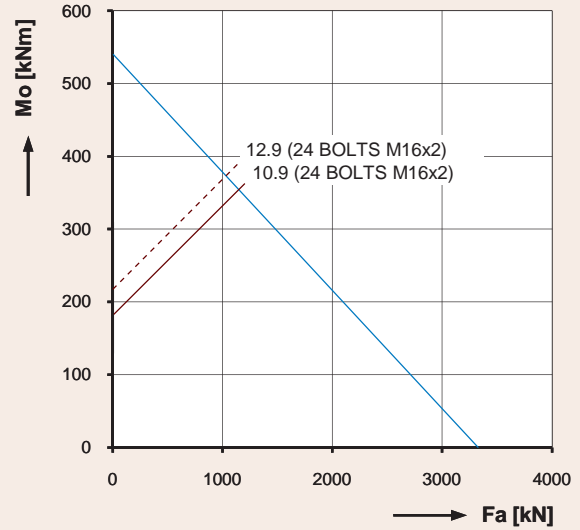

9E-1B25-0765-1347

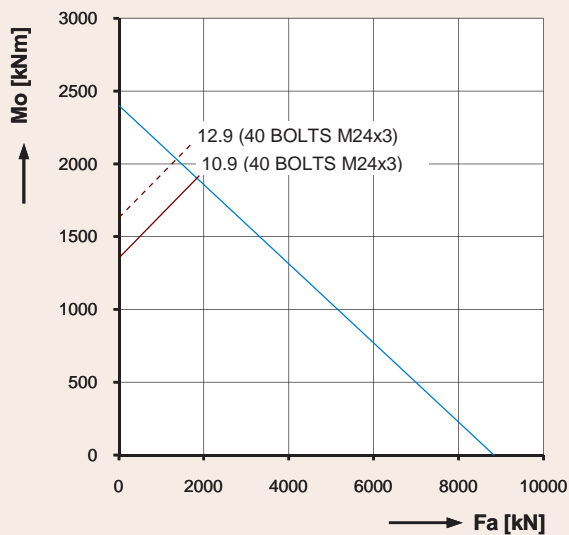

9E-1B40-1278-1349

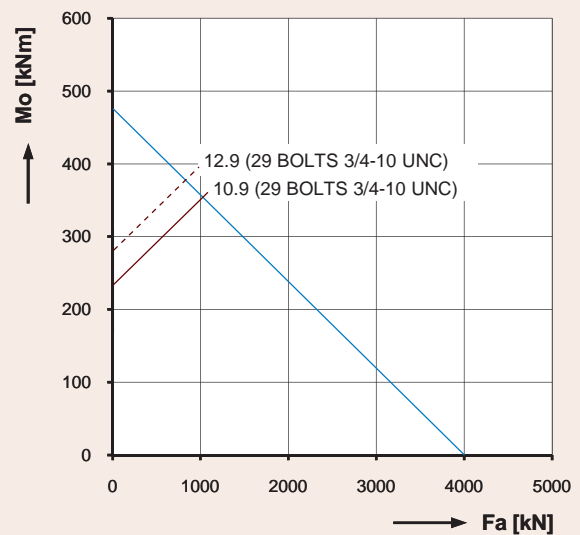

9O-1B45-0559-1350

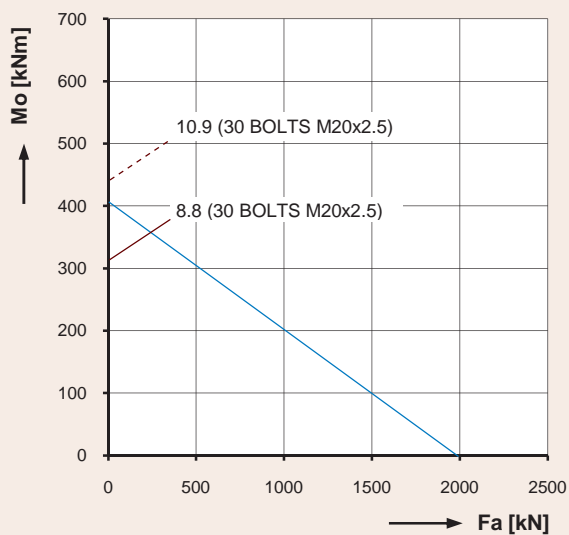

9O-1Z30-0820-1351

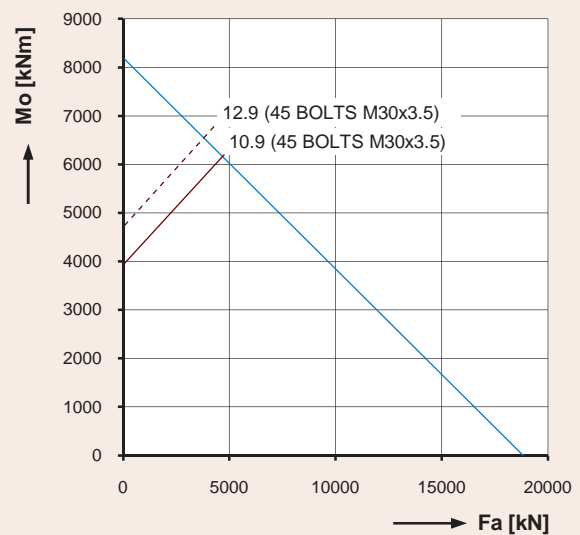

9I-1B60-2045-1353

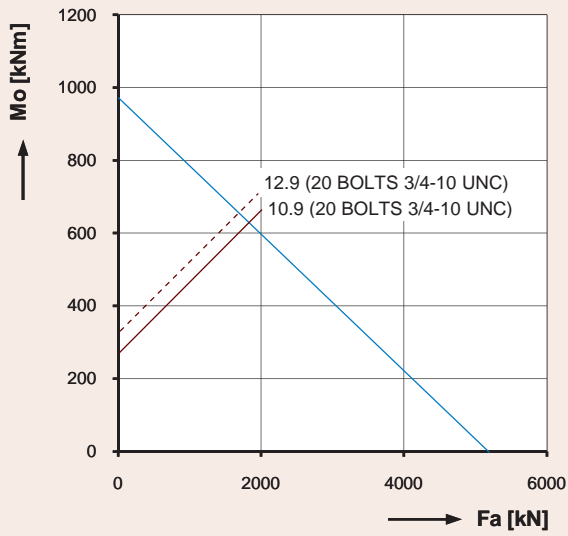

90-1B40-0883-1354

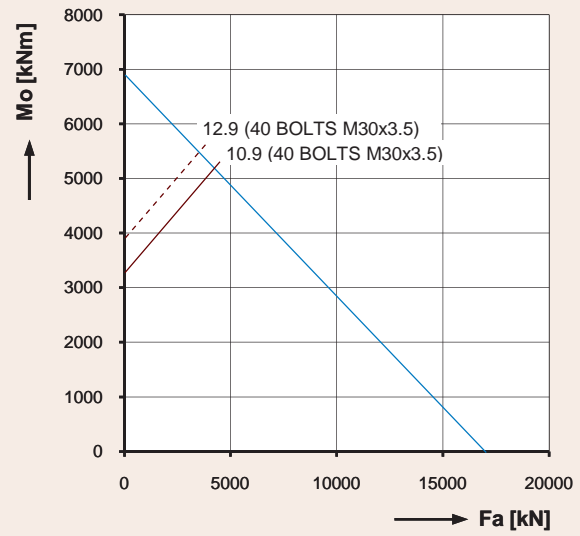

9E-1B60-1908-1358

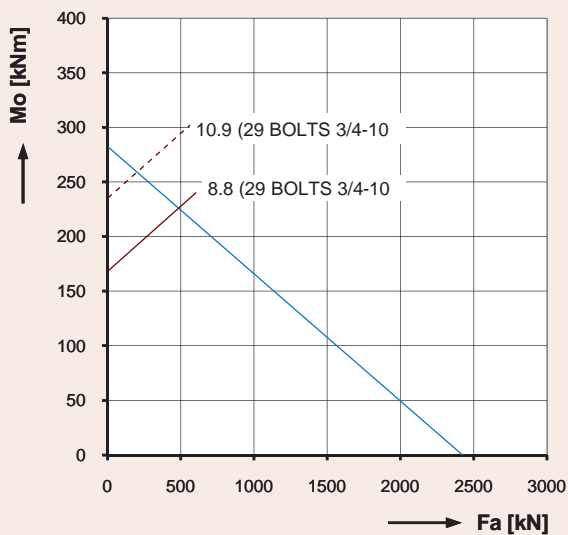

90-1B32-0548-1361

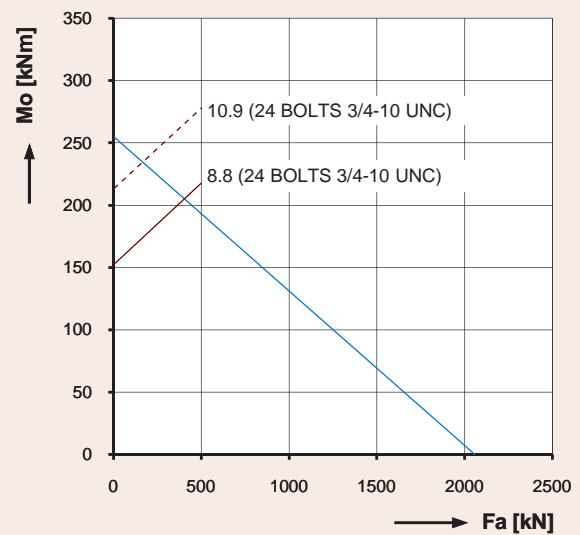

9E-1B25-0584-1365

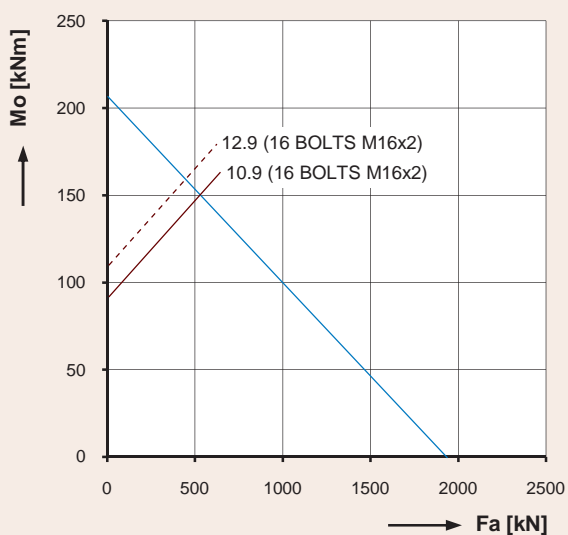

9E-1B25-0505-1368

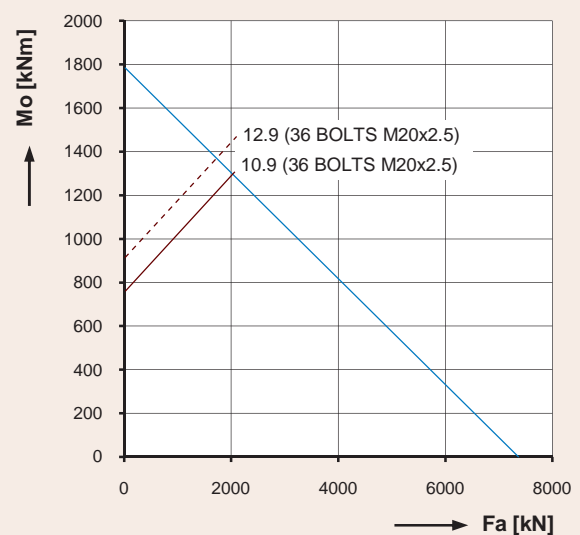

9E-2B25-1139-1386

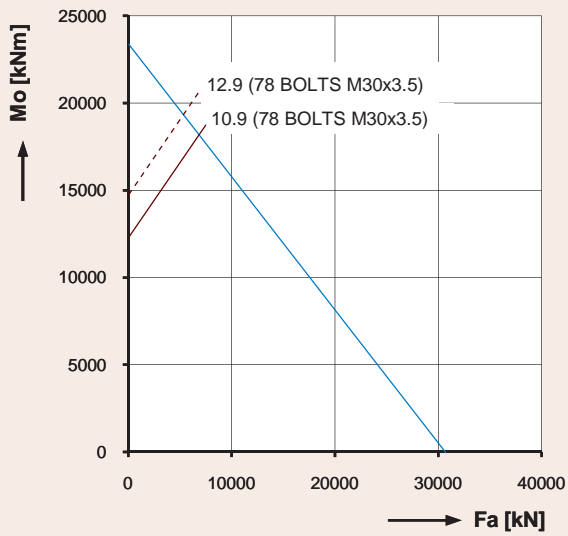

9E-1B60-3585-1387

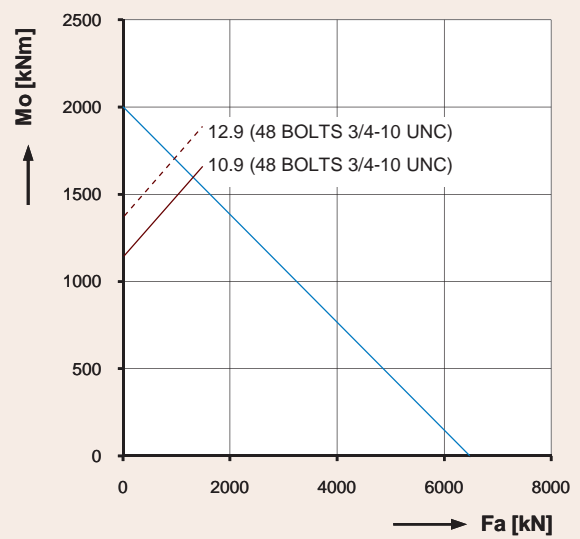

9I-1B30-1455-1389

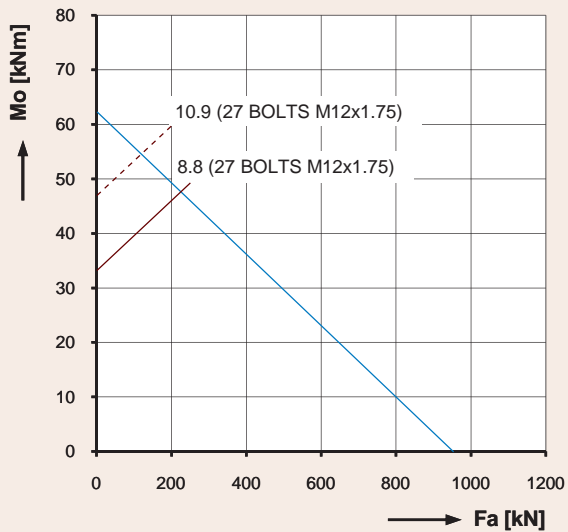

9E-1B22-0308-1397

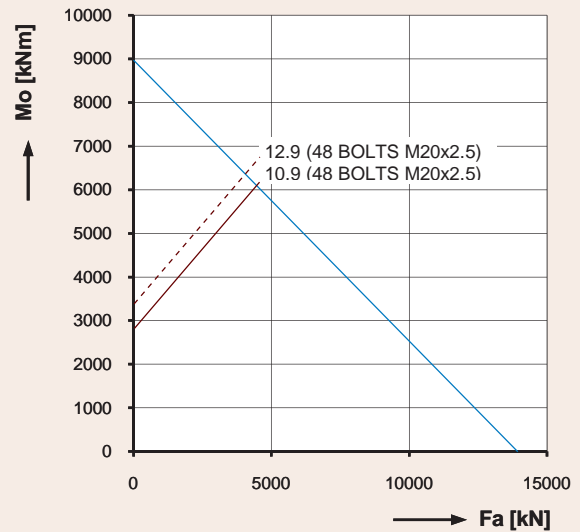

9E-1B32-3031-1399

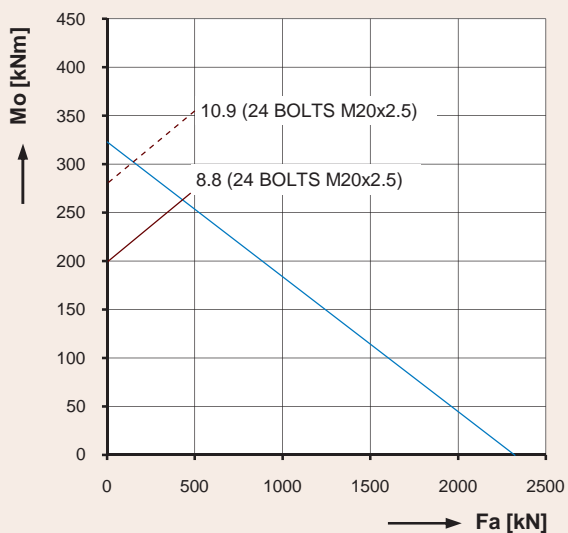

9I-1B25-0655-1400

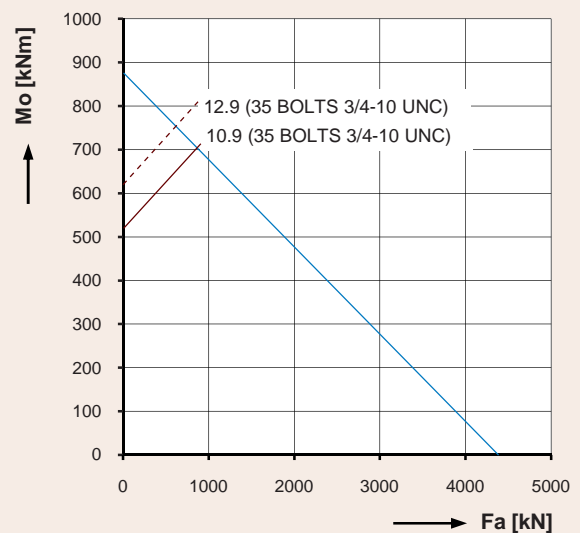

9E-1B32-0940-1401



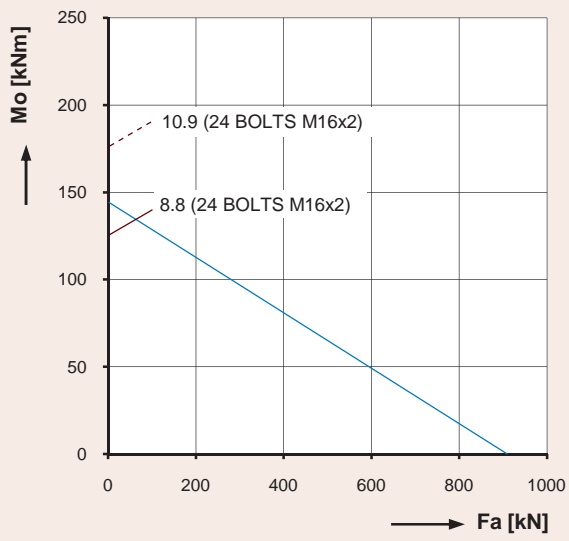

9I-1Z18-0635-1402



## CUSTOMER REQUIREMENTS ON PSL PRODUCT – SLEWING RING

### 1. Customer

Company name:		
Address:		
Town:	ZIP:	State:
Contact person:	Depart.:	
Phone:	Fax:	E-mail:

### 2. Application

Description of application, machine:

Machine type: Info also available at web:

Bearing will be used for:  New application  Replacement, spare parts

### 3. Operation / Speed

Rotating ring:	<input type="checkbox"/> Outer ring	<input type="checkbox"/> Inner ring
Axis of rotation:	<input type="checkbox"/> Vertical axis <small>(Bearing installed horizontally)</small>	<input type="checkbox"/> Horizontal axis <small>(Bearing installed vertically)</small>
	<input type="checkbox"/> Angular <small>(Please, specify in Remarks)</small>	<input type="checkbox"/> Variable <small>(Please, specify in Remarks)</small>
Direction of rotation:	<input type="checkbox"/> Mainly one-direction	<input type="checkbox"/> Cyclic (Oscillating)
Way of rotation:	<input type="checkbox"/> Continuous	<input type="checkbox"/> Interrupted/Intermittent
Maximal speed:	rpm	Maximal angle of rotation
Required life:	hours or	cycles
Remarks:		

### 4. Dimensions

	Most suitable		Acceptable range	
Outer diameter	mm	inch	mm (max)	inch (max)
Inner diameter	mm	inch	mm (min)	inch (min)
Overall height	mm	inch	mm (max)	inch (max)
Fixing bolt circle diameter:	Outer ring (most suitable)		Inner ring (most suitable)	
	mm	inch	mm	inch

### 5. Bearing loads

Load cases	Loads			Gear**		Rotational speed		Time Share %
	Axial*	Radial	Moment	Tooth load	Gear torque	Max	Average	
1								
2								
3								
4								
<b>Maximum</b>								

Unit of measurement  kN, kNm  lbs, lbs.ft

\* Axial loads positive if compression, negative if tensile  
 \*\* Please, fill one data only, either tooth load or torque ring gear



## 6. Gear requirements

<input type="checkbox"/> External gear Tooth form:	<input type="checkbox"/> Internal gear Modul/DP:	<input type="checkbox"/> No gearing Contact angle - $\alpha$ :
	Pinion	Geared ring
Number of teeth – z		
Profile correction – xm		
Gear width – b		
Other requirements (precision, quality):		
<i>Notes: Please, include the drawing of the pinion if possible</i>		

## 7. Bolts

<input type="checkbox"/> Metric only Bolt diameter:	<input type="checkbox"/> SAE only Bolt material:	<input type="checkbox"/> Metric or SAE
Outer ring bolt holes:	Inner ring bolt holes:	
<input type="checkbox"/> Thru without thread	<input type="checkbox"/> Thru without thread	
<input type="checkbox"/> Thru and counterbored	<input type="checkbox"/> Thru and counterbored	
<input type="checkbox"/> Thru tapped	<input type="checkbox"/> Thru tapped	
<input type="checkbox"/> Tapped and counterbored	<input type="checkbox"/> Tapped and counterbored	
<input type="checkbox"/> Tapped and dead hole	<input type="checkbox"/> Tapped and dead hole	
<input type="checkbox"/> Without special request	<input type="checkbox"/> Without special request	

## 8. Special requirements

<input type="checkbox"/> Seals are required	<input type="checkbox"/> Extremely dirty
<input type="checkbox"/> No grease lubrication	<input type="checkbox"/> Oil lubrication
Location specification of grease holes:	
Outer ring	Inner ring
<input type="checkbox"/> Outer diameter	<input type="checkbox"/> Inner diameter
<input type="checkbox"/> Mounting site	<input type="checkbox"/> Mounting site
<input type="checkbox"/> Other (specify in Remarks)	<input type="checkbox"/> Other (specify in Remarks)
<input type="checkbox"/> High temperature (>50 °C)	Max. temperature
<input type="checkbox"/> Low temperature (<-25 °C)	Min. temperature
<input type="checkbox"/> Precise/Preloaded bearing (Please provide details in Remarks)	
<input type="checkbox"/> Rolling elements must be caged. No spacers	
Remarks:	
<i>For full understanding of your requirements please provide, if possible, applicable drawings or sketches.</i>	

## 9. Offer

Required date of offer:	
Required date of delivery:	
Demanded quantity:	pcs
Annual requirements:	pcs/year

Individual consultation required. Please call for appointment

## Please send the filled questionnaire to one of the following address:

Thank you very much for your cooperation

PSL, a.s. Slovakia tel: +421 42 4371 460 fax: +421 42 4326 644 e-mail: pslpb@pslas.com	PSL Wälzlager GmbH Germany +49 6074 828 98 30 +49 6074 828 98 331 info@psl-gmbh.de	PSL of America, Inc. USA +1 330 405 1888 +1 330 405 1398 sales@pslamerica.com	PSL OOO Russia +7 495 925 6187 +7 495 925 6188 pslopora@yandex.ru
--	--	---	---



## TYPICAL APPLICATIONS INVOLVING PSL SLEWING RINGS



The contents of this catalog have been carefully evaluated and checked, however due to continued technical developments, PSL reserves the right to make technical changes or amendments without prior notice.

© PSL, a. s. 2010

# OTHER PSL LITERATURE



rolling bearings



technical handbook



88/2010-TPV-A



crossed tapered roller bearings



production program

88/2008-LEB-A



rolling bearings



production program

88/2010-VLD-A



slowing rings



technical handbook



88/2010-TPD-A



worm drives



production program

14/2008-PIA-REV.1



slowing rings



mounting and maintenance



18/2010-PIA-REV.1





#### **Headquarters and Production Plant**

##### **PSL, a. s.**

Robotnícka ul., 017 01 Považská Bystrica, Slovakia

Phone: +421 42 4371 111, Fax: +421 42 4326 644

E-mail: [pslpb@pslas.com](mailto:pslpb@pslas.com)

[www.pslas.com](http://www.pslas.com)



#### **Sales to the USA**

PSL of America, Inc.

2003 Case Parkway South

Twinsburg, Ohio 44087

USA

Phone: +1 330 405 1888

Fax: +1 330 405 1398

E-mail: [sales@pslamerica.com](mailto:sales@pslamerica.com)

[www.pslamerica.com](http://www.pslamerica.com)

#### **Sales to West Europe**

PSL Wälzlager GmbH

Waldstrasse 23/B3

631 28 Dietzenbach

Germany

Phone: +49 6074 8289 83 0

Fax: +49 6074 8289 83 31

E-mail: [info@psl-gmbh.de](mailto:info@psl-gmbh.de)

#### **Sales to Russia**

PSL OOO

ul. Krasnogo Mayaka 26

117 570 Moscow

Russian Federation

Phone: +7 495 925 6187

Fax: +7 495 925 6188

E-mail: [pslopورا@yandex.ru](mailto:pslopورا@yandex.ru)