

# VIB|CHECKER



# User Guide



# Contents

|   |           |
|---|-----------|
| <b>Introduction</b> .....                                 | <b>4</b>  |
| Condition-based maintenance .....                         | 4         |
| <b>Instrument overview</b> .....                          | <b>5</b>  |
| Instrument parts.....                                     | 5         |
| General description .....                                 | 5         |
| Displays and icons.....                                   | 6         |
| Battery .....   | 9         |
| Start up.....   | 10        |
| <b>Settings</b> .....                                     | <b>11</b> |
| Default settings.....                                     | 11        |
| Using external sensors .....                              | 17        |
| Sensors with magnets (option).....                        | 17        |
| Bias voltage .....  | 18        |
| <b>Vibration severity measurement</b> .....               | <b>19</b> |
| Vibration parameters ACC, VEL, DISP .....                 | 19        |
| Built-in sensor with probe .....                          | 20        |
| Measuring points .....                                    | 20        |
| <b>Measurement</b> .....                                  | <b>21</b> |
| Recording readings for follow-up .....                    | 22        |
| Storing measurement results .....                         | 23        |
| <b>Spectrum analysis</b> .....                            | <b>24</b> |
| Spectrum display .....                                    | 24        |
| Zoom .....  | 24        |
| RPM, manual input.....                                    | 25        |
| Adding markers for harmonics.....                         | 25        |
| <b>Time signal analysis</b> .....                         | <b>26</b> |
| Time signal display.....                                  | 26        |
| Zoom .....  | 26        |
| <b>ISO 2372</b> .....                                     | <b>27</b> |
| Evaluation of machine condition.....                      | 27        |
| Definition of machine classes according to ISO 2372 ..... | 28        |
| <b>ISO 10816</b> .....                                    | <b>29</b> |
| ISO 10816 Part 2.....                                     | 29        |
| ISO 10816 Part 3.....                                     | 30        |
| ISO 10816 Part 4.....                                     | 31        |
| <b>Technical specifications</b> .....                     | <b>32</b> |
| VibChecker VC200/250.....                                 | 32        |
| Accessories .....   | 32        |
| <b>Maintenance and calibration</b> .....                  | <b>33</b> |
| Maintenance .....   | 33        |
| Calibration .....   | 33        |
| Warranty .....  | 33        |

# Document Outline

This User Guide contains useful information about the VibChecker, beginning with general information about instrument parts, user interface, battery and settings.

This document also describes the hands-on use of the instrument, and how to confirm and evaluate measurement results.

References to icons, displays and modes in the instrument are in **bold** text. References to instrument keys are in capital letters.

## Safety notes

- The instrument is intended for professional, industrial process, and educational use only while taking into consideration the technical specifications. The accessories may only be used for their respective intended purpose as defined in this User Guide.
- The instrument must not be used in environments outside of the temperature range specified under "*Technical specifications*" in this User Guide, as the battery may be damaged and may cause harm or danger.
- When measuring, ensure that no cables, etc. can be caught in rotating parts which can cause injury.
- For safety reasons, the measurement device must only be operated and maintained by properly trained personnel.
- The battery should be charged in a dry office environment with a temperature range within 0 to +45 degrees °C (0 to 113 °F). If the battery is charged in an environment outside of specified temperatures, it may be damaged.
- The service and repair of the measurement device may only be performed by an SPM authorized service technician.



# Introduction

## Condition-based maintenance

Condition-based maintenance (CBM) is a widely accepted concept in industry. The idea is simple: keep plant machinery in good working condition by locating and repairing minor faults before they grow large enough to cause expensive breakdowns and production stops.

The challenge is to assess machine condition and detect a slow deterioration long before a piece of equipment grinds to a shuddering halt. In the past, a skilled operator could do this largely without the help of instruments, by listening, touching, and smelling. Modern machinery is often unattended, sound-proofed, or out of easy reach. It rotates faster and is less massively constructed, which means that even a minor deterioration of its working condition can have very serious consequences. Therefore, personal skill and subjective judgment have to be supported by monitoring systems and instrument readings.

## Vibration monitoring

Vibration monitoring is a very useful method for overall assessment of machine condition. Changes in the vibration level always imply changes in the operating condition. Excessive vibration basically has three potential causes: something is loose, misaligned, or out of balance. These three causes cover virtually all possible mechanical faults.

Moreover, the assessment of machine vibration has been much simplified by international standards which define the acceptable vibration level for a given type of machine and recommend monitoring methods suitable for industrial purposes.

Effective condition-based maintenance requires economical and simple monitoring methods which can be applied by maintenance personnel without special training. Their primary task is to locate trouble spots early and direct the efforts of the maintenance crews to the right place at the right time. Fault analysis and repairs are a secondary step which may require expert knowledge and a different type of instrumentation.

VibChecker is designed as a maintenance aid. In accordance with the international standards, it measures vibration severity over the frequency range 10 to 1000 Hz. It allows a practical classification of machine condition in relative terms: good, acceptable, just tolerable, or bad. Regular measurements will also show the development trend of the vibration level and thus the urgency of the maintenance problem: stable condition, slow deterioration or fast deterioration.

# Instrument overview

## Instrument parts

- A Measuring probe (VC200)
- B Sensor input
- C Graphical display with LED backlight
- D MEASURE key
- E Navigation keys
- F BACK key and power on
- G Mini-B USB communication output

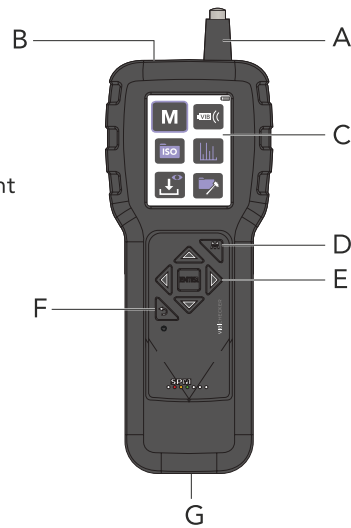

## General description

VibChecker is an instrument for fast and easy measurement of machine condition in preventive maintenance. The instrument and the monitoring techniques are based on the recommendations of ISO2372 and ISO10816 (Part 2, 3, 4 >600 RPM) standards for broadband measurement of vibration. These standards make the assumption that limited information, obtained easily and at a low cost, is often as useful as a detailed analysis using expensive equipment and elaborate techniques.

VibChecker is battery powered and designed for use in harsh industrial environments. The graphical display (C) shows the condition readings and – if ISO 10816 or ISO 2872 is activated – provides evaluated machine condition in green-yellow-red.

The instrument has a built-in probe sensor (A). The external sensors with magnets TRM100, TRM120, and all types of SPM vibration sensor series SLD for permanent installation can also be used, connected to the sensor input (G). It is push-key controlled and basic measurement setup information is entered manually. Evaluated measurement results are indicated by green-yellow-red condition indicators and an FFT spectrum is produced for pattern recognition. Up to ten readings can be saved to memory.

# Displays and icons

## Main display

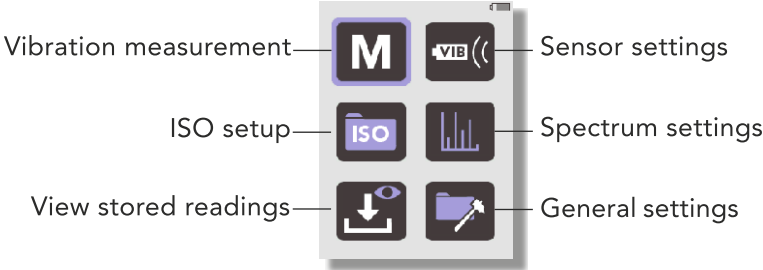

## Navigation keys

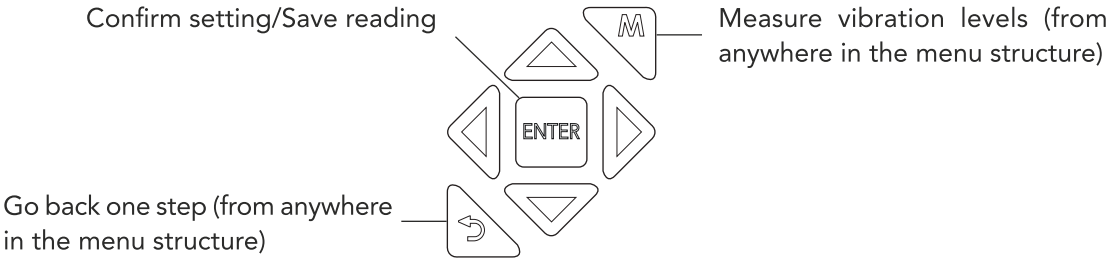

# General settings

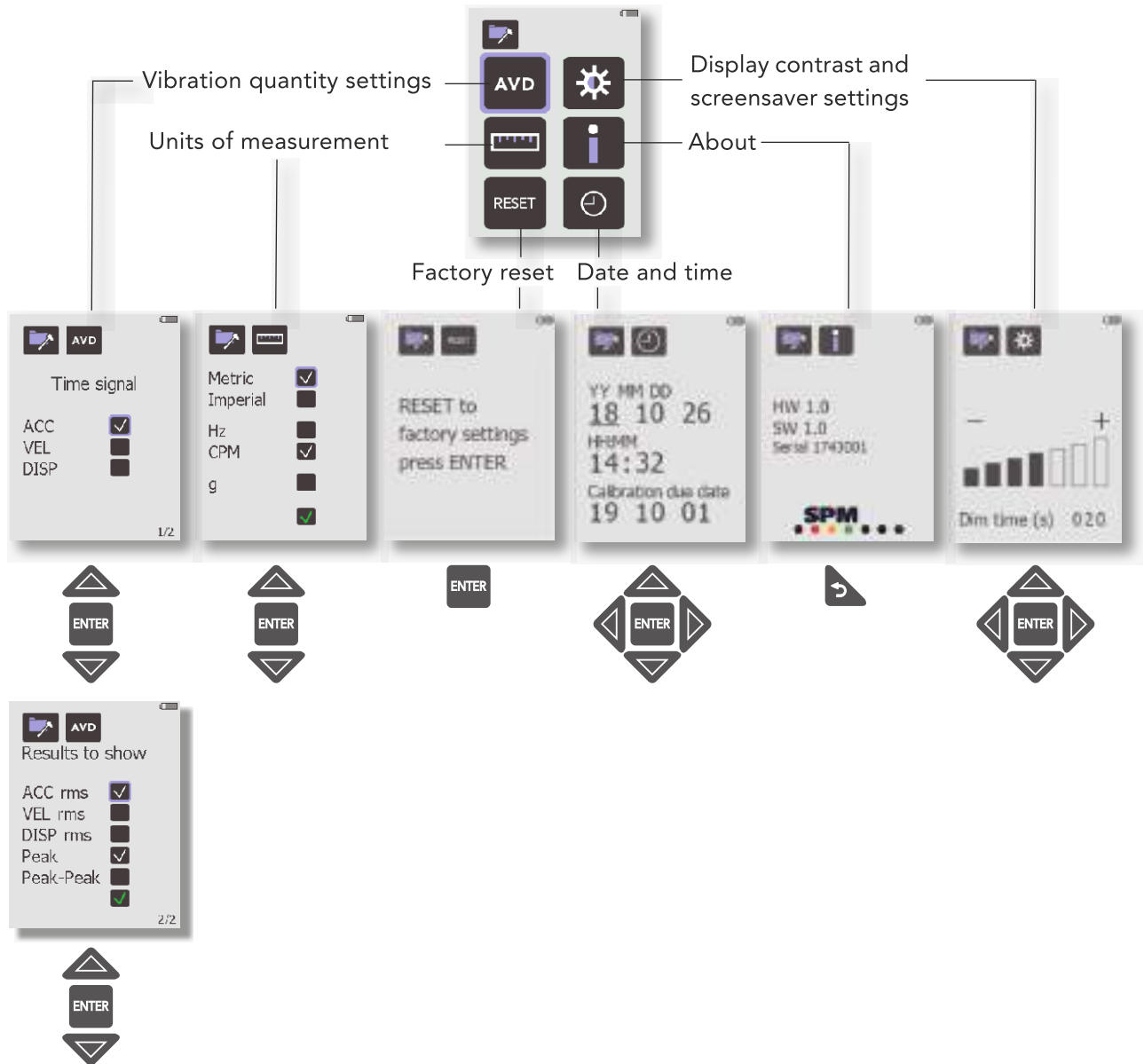

# M Vibration measurement

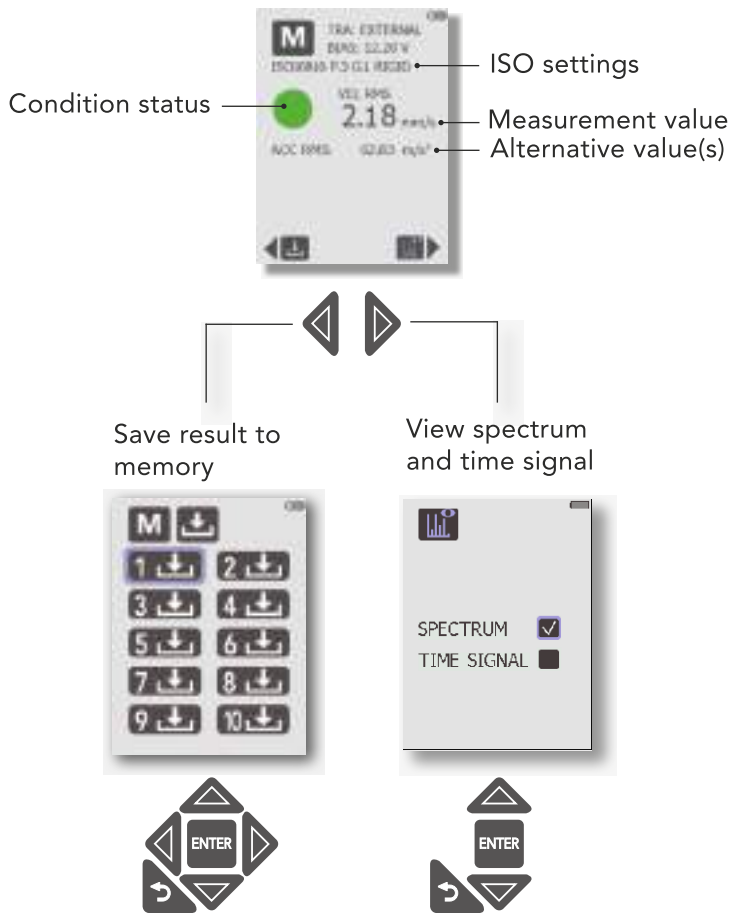

# Spectrum analysis

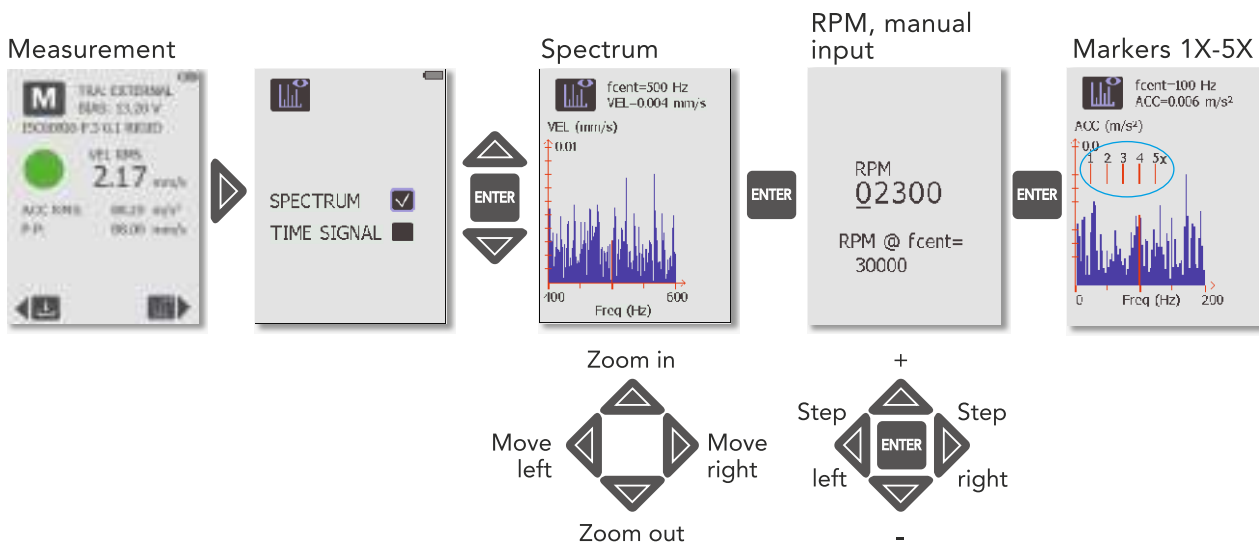



## Battery

The instrument is powered by a lithium-ion battery, which is charged using a charger connected to the instrument's USB communication output (or other USB output with the specifications 5V/500 mA).

**Please note that the instrument must be sent to a certified SPM service and calibration partner for replacement of a discharged battery.**

### Charging the battery

The battery charge icon in the upper right corner of the **Main** display (A) shows the current battery status. The icon turns red when the battery is low (<10%) and needs recharging.

The battery should be charged in a dry office environment with a temperature range within 0 to +45 degrees °C (0 to 113 °F). If the battery is charged in an environment outside of specified temperatures, it may be damaged.

A flash symbol to the left of the battery charge icon indicates that a charging cable is inserted. When the battery charge icon is green, the battery is charging. When it turns gray, the battery is fully charged.

Should the battery charge icon be full but in red color, something is wrong with the charging system or circuitry, and the instrument needs to be sent to SPM Instrument for service.

### Extending battery life

Avoid deep cycling of the battery. Each cycle wears the battery down by a small amount and a partial discharge is better than a full discharge. Lithium-ion is maintenance-free and the battery lasts longest when operating between 30 and 80 percent. Store the instrument partially charged in a cool and dry place.

The battery will gradually self-discharge even if stored in a partially charged state. Self-discharging increases with age, usage, and elevated temperature.

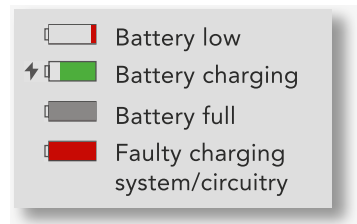
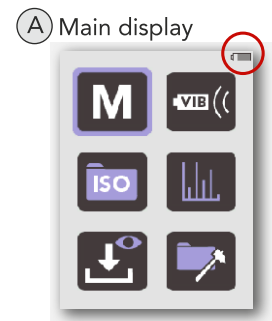

## Start up

Press and hold the **BACK** key (A) to switch on the instrument. Vib-Checker always starts in the **Main** display.

Settings and instrument functions are selected using the arrow and **ENTER** keys (B).

For all VibChecker versions, measurement is started manually from the **Measurement** display, which is opened by pressing the **MEASURE** key (C) from anywhere in the menu structure.

In the **Measurement display**, a new vibration measurement is started by pressing the **MEASURE** key again. A blue pixel at the bottom of the display indicates that the measurement cycle has started. The display backlight then turns off until the measurement completes.

When idle, the instrument automatically and successively goes into energy saving mode, first by dimming the display backlight according to the user-defined screensaver timeout (for more information, see chapter *“Display contrast and screensaver timeout”* in this user guide). Next, after another twenty seconds, the backlight turns off entirely, with the instrument still running. At this stage, reactivate the backlight by pressing any key. Finally, after a further two minutes of inactivity, VibChecker automatically turns off completely. Restart the instrument with the **BACK** key.

The instrument can also be shut off manually by briefly pressing and holding the **BACK** key.

### Forcing instrument reset

Should the instrument have a lockup problem, prompt a reset by pressing the **ENTER** key for approximately five seconds.

NOTE: This action does not initiate an instrument reset back to factory settings.

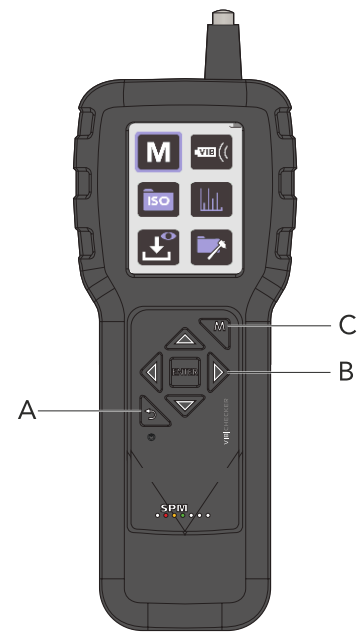

## Settings

### Default settings

Below is a summary of the main instrument settings and their respective factory default values:

ISO standard = OFF (no condition evaluation will take place)

ISO 10816 default settings = PART 3, GROUP 1, SUPPORT Rigid

ISO 2372 default settings = CLASS 1, RPM 1500

Vibration quantity = VEL (velocity)

Amplitude units = Velocity rms and Peak

Units = Metric, Hz, vibration amplitude in g turned off

Averaging turned off

Number of lines = 200

External transducer = 10 mV/m/s<sup>2</sup>, settling time 3.0 seconds

Display contrast = Max

Dim time = 20

### System of measurement and units

Available settings include the metric or imperial system; frequency in Hz (Herz, cycles per second) or CPM (cycles per minute - similar to RPM); and acceleration in g or m/s<sup>2</sup>.

To make your settings:

1. Go to the **Main display** (A).
2. Use the arrow keys to navigate to the **General Settings** icon (B), then press **ENTER**.
3. In the **General settings** display, select the **Units** icon (C) and press **ENTER**.
4. In the **Units** display (D), use the **UP/DOWN** arrow keys to highlight a checkbox (Metric (millimeters) or Imperial (inch); Hz or CPM; and g). For each selection, press **ENTER** to mark your choice.
5. To save the settings, use the **DOWN** arrow key to highlight the **SAVE** checkbox and press **ENTER**.

To return to the **Main display**, press the **BACK** key.

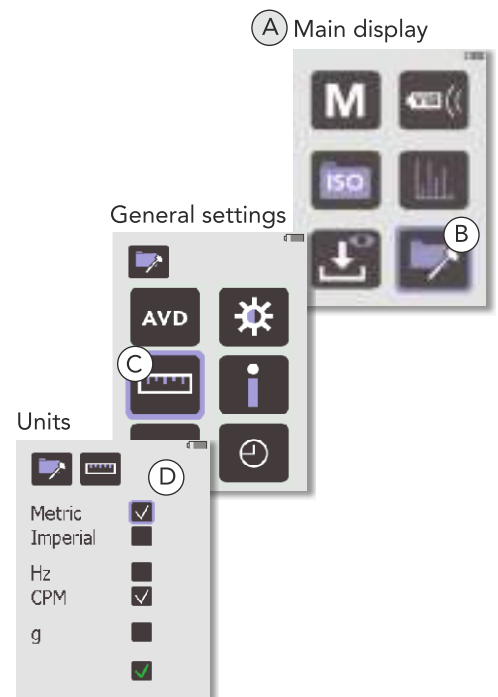

## Display contrast and screensaver timeout

To set the display contrast and the amount of idle time that should elapse before the screensaver is activated:

1. Go to the **Main display** (A).
2. Use the arrow keys to navigate to the **General Settings** icon (B), then press **ENTER**.
3. In the **General Settings** menu, select the **Display contrast** icon (C) and press **ENTER** to open the display contrast and screensaver settings (D).
4. Use the **UP/DOWN** arrow keys to set the time to wait (5 - 600 seconds) before the screensaver dims the display backlight.
5. Use the **LEFT/RIGHT** arrow keys to set the display contrast.
6. Press the **ENTER** key to save your settings and return to the **General settings** menu.

To return to the **Main display**, press the **BACK** key.

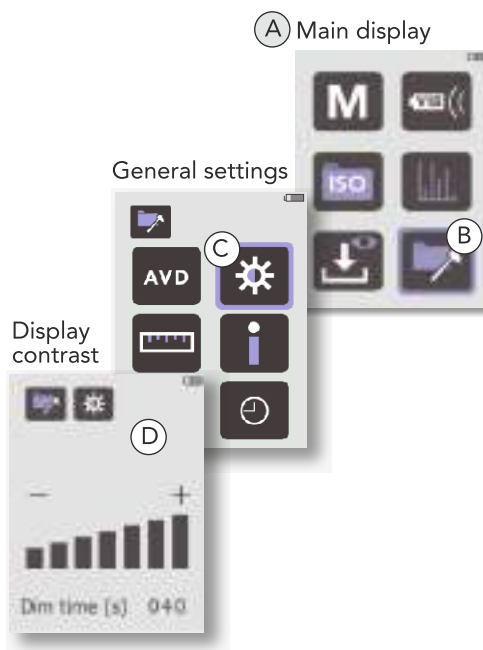

## Date/time

It is essential that the instrument has the correct date and time to avoid confusion when saving measuring results to memory.

To set date and time:

1. Go to the **Main display** (A).
2. Use the arrow keys to navigate to the **General Settings** icon (B), then press **ENTER**.
3. In the **General settings** display, select the **Date and time** icon (C) and press **ENTER**.
4. In the **Date and time** display (D), use the **LEFT/RIGHT** arrow keys to select positions and the **UP/DOWN** arrow keys to change the setting.
5. Press **ENTER** to save the settings and return to the **General Settings** display.

To return to the **Main display**, press the **BACK** key.

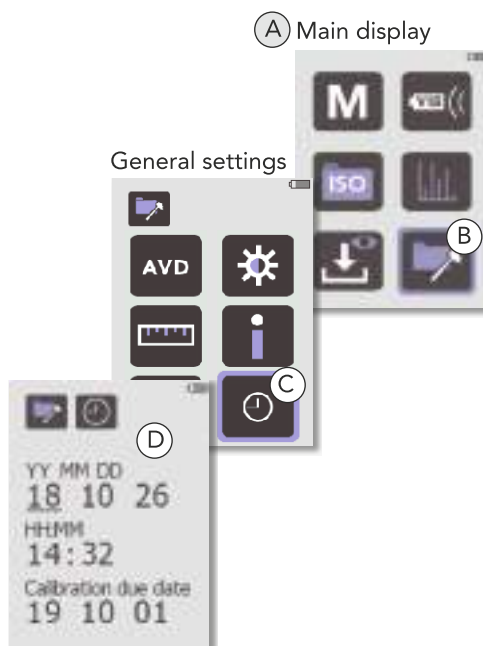

## ISO standard setup

When an ISO standard is activated, the instrument automatically evaluates the readings according to the selected ISO standard and indicates machine condition with a green, yellow or red condition indicator in the **Measurement** display. With ISO = OFF, no condition evaluation will take place.

VibChecker bases condition evaluation on ISO recommendations, with the exception that good and acceptable condition are both evaluated as green.

Machine condition evaluation according to ISO standards require correct classification of the monitored machine (for more information, see the 'ISO 2372' and 'ISO 10816' sections).

To select ISO 10186 or ISO 2372:

1. Go to the **Main** display (A).
2. Use the arrow keys to navigate to the **ISO setup** icon (B), then press **ENTER**.
3. In the **ISO** display (C), use the **UP/DOWN** arrow keys to highlight the preferred ISO standard, then press **ENTER** to select it.
4. On the display shown next, further settings are required (with one exception).

For ISO 10816:

- Use the **UP/DOWN** arrow keys to select **PART** (2, 3, or 4).
- When **PART 2** is selected (D), step to 'RPM' with the **RIGHT** arrow key, then use the **UP/DOWN** keys to select '1500 or 1800' or '3000 or 3600'.
- When **PART 3** is selected (E), step to 'GROUP' with the **RIGHT** arrow key and use the **UP/DOWN** keys to select 'GROUP' (1-4). Then move on to the 'SUPPORT' setting with the **RIGHT** arrow key and use the **UP/DOWN** keys to select 'Flexible' or 'Rigid'.
- For **PART 4**, no further input is required (F).

For ISO 2372:

- Use the **UP/DOWN** arrow keys to select machine 'CLASS' 1-6 (G).

5. Press **ENTER** to save the ISO settings and return to the **Main** display.

VibChecker is now ready for measurement with evaluated machine condition according to the selected ISO standard.

NOTE: Condition evaluation according to ISO standards requires that the vibration quantity is set to VEL (for more information, see section 'Vibration quantity and amplitude units').



ISO 10816, Part 2 settings

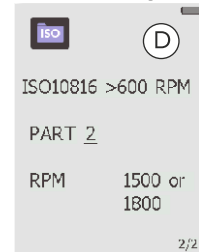

ISO 10816, Part 3 settings

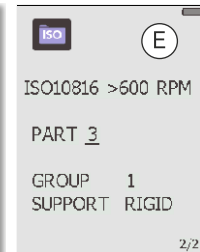

ISO 10816, Part 4



ISO 2372, machine class settings

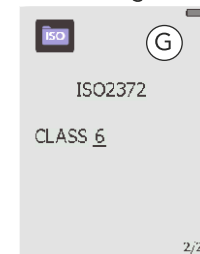

## Vibration quantity and amplitude units

The selected vibration quantity (acceleration, velocity, or displacement) affects the unit for the result shown in the **Measurement** display as well as the spectrum and time signal unit. The default setting is Velocity (VEL).

To set the vibration quantity:

1. Go to the **Main display** (A).
2. Use the arrow keys to navigate to the **General settings** icon (B), then press **ENTER**.
3. In the **General Settings** menu, select the **AVD** icon (C) and press **ENTER**.
4. In the first of two **AVD** displays (D), use the **UP/DOWN** arrow keys to highlight the appropriate vibration quantity and press **ENTER** to mark it. The second display opens (E).

**NOTE:** If an ISO standard has been activated in the **ISO setup** display, only VEL can be selected here (for more information, see section '*ISO standard setup*').

5. Using the **UP/DOWN** arrow keys, highlight the checkbox of the metrics to show in the **Measurement** display, and press **ENTER** to mark your choice.
6. To save the settings, use the **DOWN** arrow key to highlight the **SAVE** checkbox and press **ENTER**.

To return to the **Main display**, press the **BACK** key.

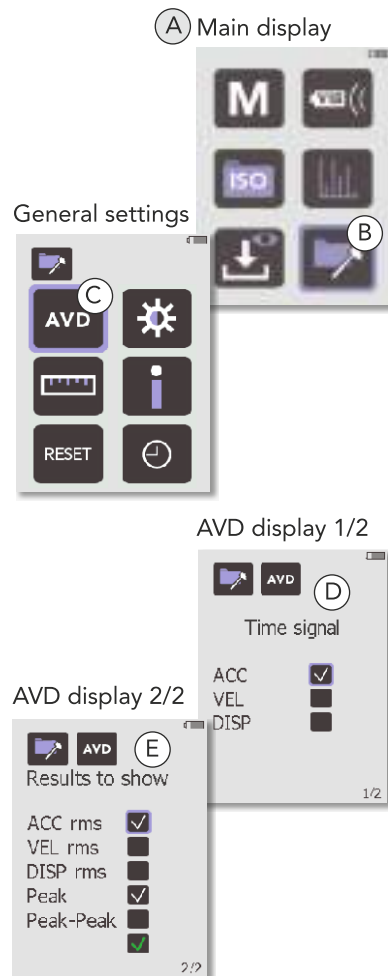

## Spectrum resolution settings

The spectrum resolution equals the maximum frequency (1000 Hz) divided by the number of lines of resolution. A higher number of lines allows more detailed spectrums; the drawback is slightly longer measurement times.

By activating the 'AVERAGE' parameter, VibChecker will perform four measurements, and then display an average of the measurement results.

To set a number of spectrum lines:

1. Go to the **Main** display (A).
2. Use the arrow keys to navigate to the **Spectrum settings** icon (B), then press **ENTER**.
3. In the **Spectrum settings** display, use the **UP/DOWN** arrow keys to highlight the checkbox for your preferred number of lines and press **ENTER** to mark it.
4. If averaging should be used, mark the 'AVERAGE' checkbox.
5. To save the settings, use the **DOWN** arrow key to highlight the **SAVE** checkbox and press **ENTER**.

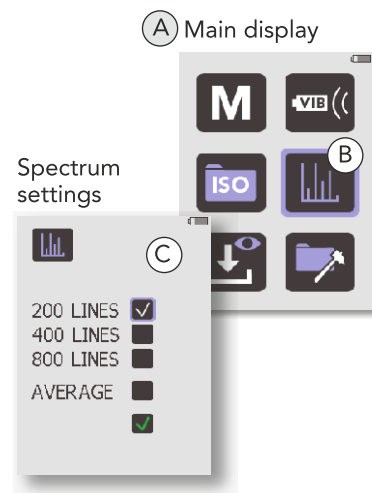

## Reset

To perform an instrument reset back to factory settings:

1. Go to the **Main display** (A).
2. Use the arrow keys to navigate to the **General Settings** menu (B), then press **ENTER**.
3. In the **General settings** display, select the **Reset** icon (C) and press **ENTER**.
4. The **Reset** display opens (D). Press **ENTER** to confirm instrument reset. A green checkmark is displayed, indicating that the reset has been done.

To return to the **Main display**, press the **BACK** key.

Pressing the **ENTER** key will reset the instrument back to the default settings listed on page 11.

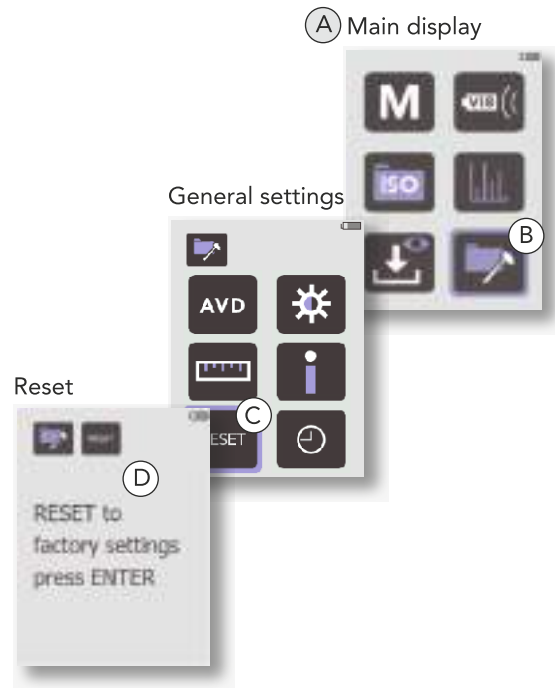

## Serial number and software version

To find out the software version and instrument serial number:

1. Go to the **Main display** (A).
2. Use the arrow keys to navigate to the **General Settings** menu (B), then press **ENTER**.
3. In the **General settings** display, select the **Information** icon (C) and press **ENTER**.
4. The **Information** display opens (D), showing the software version and serial number.

To return to the **Main display**, press the **BACK** key twice.

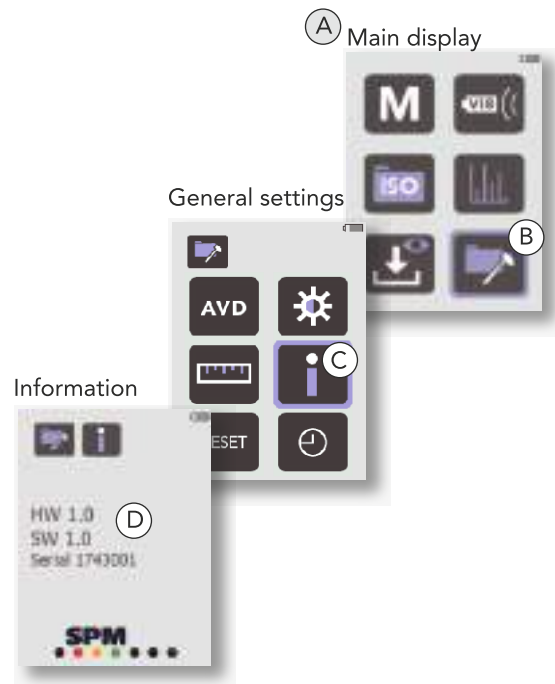



## Using external sensors

VibChecker can be used with all accelerometers of type IEPE (ICP®) with voltage output.

To configure VibChecker for measurement with an external vibration sensor:

1. Connect the sensor to the input connector (mini coax).
2. Go to the **Main** display (A).
3. Use the arrow keys to navigate to the **External sensor** icon (B), then press **ENTER**.
4. In the **External sensor** display (C), use the **LEFT/RIGHT** arrow keys to position the cursor and adjust the sensitivity with the **UP/DOWN** keys.
5. To select the appropriate unit (mV/m/s<sup>2</sup> or mV/g), position the cursor with the **LEFT/RIGHT** keys. Press the **UP** key to toggle and select a quantity.
6. To adjust the settling time (i.e. the time it takes for the sensor to reach a stable output), position the cursor with the **LEFT/RIGHT** keys. Set the correct time using the **UP/DOWN** keys.
7. Press **ENTER** to save the settings and return to the **Main** display.

Vibration sensors of type SLD and sensors from other manufacturers have actual sensitivities and settling times written on their calibration cards. When several sensors are in use, they should be marked to assure that the readings are calibrated.

### Sensors with magnets (option)

The vibration sensors with magnets, TRM100 and TRM120 (options), can be used for attachment to ferrous metal parts to reach measuring points in narrow spaces and has the same construction and method of operation as the built-in sensor.

The firmer the contact with the machine, the better the measuring result. Plain, clean metal makes the best contact surface for the vibration sensor. To get comparable results, the measuring points should be clearly marked, so that measurements can always be taken in the same spots.

Before starting vibration measurements, make sure that the sensitivity for the vibration sensor you are using is properly set up. The sensors with integral magnet TRM100/120 have a nominal sensitivity of 10.2 mV/m/s<sup>2</sup> (individual value given on the calibration chart). The settling time is 2 seconds.

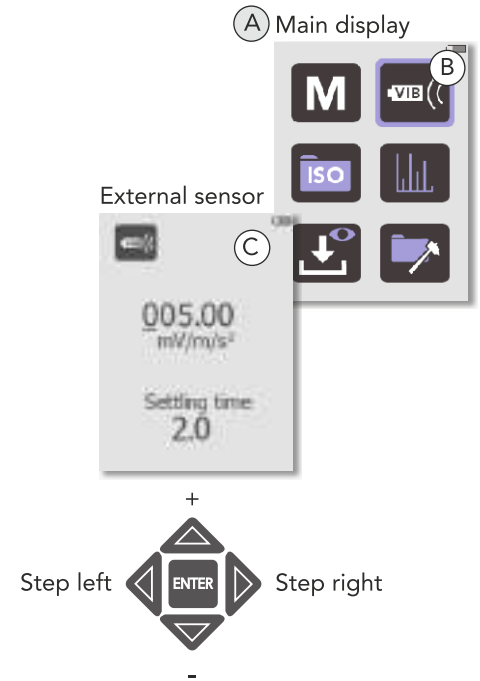

TRM100



TRM120

Sensors with integral magnet

## Bias voltage

When measuring vibration with external sensors, a bias voltage check will automatically be made to check the quality of the signal transmission between sensor and instrument. Part of your signal will be lost in a poor sensor line, so your measuring results will be incorrect. If a measurement is made with a poor sensor line, the instrument will display Bias error.

If there is an open circuit (broken cable or no sensor connected) the bias value is  $>16$  V. If the bias value is  $<8$  V, the connectors, cable, and sensor should be checked for short circuit.



# Vibration severity measurement

If a fan is out of balance, it will shake at its speed of rotation, i.e. move backwards and forwards once per revolution. The number of vibrations per time unit is the vibration frequency, measured in **Hz** (Hertz = cycles per second) or **CPM** (cycles per minute).

The rotational speed of any piece of plant is known as its fundamental frequency. For a fan with a speed of 1500 RPM the fundamental frequency is 25 Hz (1500 RPM ÷ 60).

In practice, machine vibration usually consists of many different frequency components. For a general assessment of machine condition one uses wide frequency band measurements, meaning all vibrations within a large frequency range are measured simultaneously.

## Vibration parameters ACC, VEL, DISP

Cyclic movement can be measured and described in three different ways; as displacement, acceleration and velocity.

A part that is moving from rest, speeding up, slowing down and stopping twice per cycle is obviously accelerating and decelerating continuously. **Acceleration** (ACC) is measured in  $\text{m/s}^2$  or  $g$  ( $1g = 9.81 \text{ m/s}^2$ ).

The second measuring parameter is the speed at which the object moves, the vibration **velocity** (VEL). Velocity is expressed in mm/sec.

**Displacement** (DISP) means the actual distance the object moves, measured either from its rest position in one direction (peak) or as the total movement in both directions (peak to peak). Displacement is expressed in micrometers.

VibChecker always measures an acceleration signal, which is integrated to obtain the velocity, and double-integrated to derive displacement.

Both acceleration and speed are constantly changing. One can measure a peak value of either, but a mean value often gives a better indication of the forces involved in the movement. Most instruments measure the **RMS** value (root mean square value) of the movement and use a scaling factor to indicate the peak levels, if they are given at all.

All three vibration parameters – acceleration (ACC), velocity (VEL), displacement (DISP) – are mathematically related. As mentioned above, the accelerometer signal can be converted, via integrating circuitry in the measuring instrument, into a reading of vibration velocity or displacement.

The choice of displayed parameter (the instrument reading) depends on the problem to be solved and on the cost, the complexity, and the reliability of the measuring equipment.

Experience has shown, that the RMS level of vibration velocity, measured over a frequency range of **10 to 1000 Hz**, is most useful for general assessment of machine condition. The technical term used is vibration severity, defined as above and displayed in mm/s RMS or in/s RMS on the instrument. Vibration severity is directly related to the energy level of machine vibration, and thus a good indicator of the destructive forces acting on the machine.

## Built-in sensor with probe

Measuring points for the built-in probe should be clearly marked. Always measure in the same spot.

The probe tip is spring loaded and moves within a sleeve of hard rubber. To maintain a steady pressure on the tip, press the probe tip against the measuring point until the rubber sleeve is in contact with the surface.

Hold the probe steady to avoid rubbing between the probe tip and the machine surface.

The probe is directionally sensitive. The centre of the probe tip should touch the surface. Avoid pressing the probe tip against cavities and fillets which are smaller than the probe tip.

The only part likely to wear out is the rubber sleeve for the probe tip. It is made of chloroprene rubber and tolerates 110° C (230° F). Spare sleeves have part number 18128.

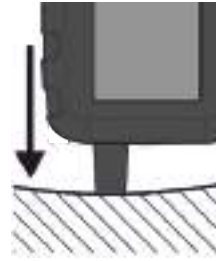

Rubber sleeve in contact with the surface. Hold steady.

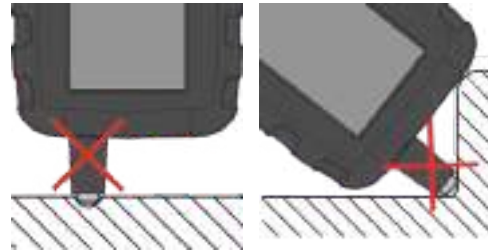

Avoid small cavities and fillets.

## Measuring points

Vibration severity is primarily a measure for general machine condition. Vibration at the measuring point should be representative for the overall vibration of the machine. Typical measuring points are on the bearing housings. By measuring in three directions, one can get an indication of the causes for increased vibration.

- Horizontal vibration (H) in the plane of rotation is most representative of balance condition.
- Vertical vibration (V) in the plane of rotation is most representative of structural weakness.
- Axial vibration (A) along the line of the shaft is most representative of faulty alignment and bent shafts.

To get comparable results, the measuring points should be clearly marked, so that measurements can always be taken in the same spots.

The firmer the contact with the machine, the better the measuring result. Plain, clean metal makes the best contact surface for the vibration sensor.

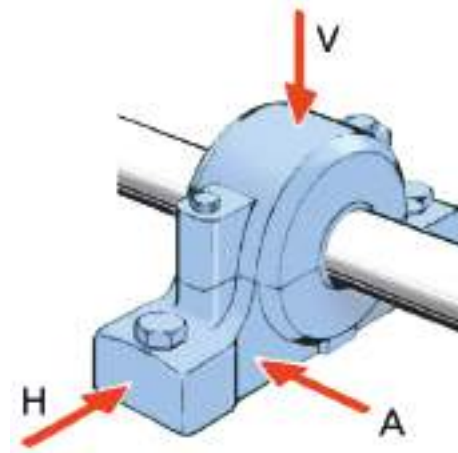

# M Measurement

For all VibChecker versions, measurement is started manually from the **Measurement** display, which is opened by pressing the **MEASURE** key from anywhere in the menu structure.

If the instrument is on and the backlight is off, nothing happens at first keypress, except that the backlight comes on. Next keypress will perform the intended action.

Before measurement, make sure that ISO standard, sensor settings, units etc. are set up.

To perform a vibration measurement:

1. In the **Main display** (A), select the **Measure** icon (B) and press **ENTER**. The **Measurement** display opens, showing the most recent reading.
2. For a new measurement, point the VibChecker straight at the measuring point and press the probe tip until the rubber sleeve is in contact with the surface (or connect the external sensor).
3. Hold the instrument steady and press the **MEASURE** key to start measurement. A single blue pixel briefly appears at the bottom of the display, indicating that a measurement cycle - beginning with an automatic bias check - is in progress. The display backlight is then turned off until the measurement is completed.

When using an external sensor, the actual measuring starts when the defined settling time has elapsed. As long as the **Measurement** display is still selected and the backlight is on, no new settling time is needed to make further measurements, unless you switch to using the built-in measuring probe.

4. When the display lights up again, it shows the measurement result according to the settings made in the instrument (C). The result is shown in large numbers, with alternative values (RMS, peak, and peak-to-peak, depending on the selected vibration quantity) shown in small numbers below. Depending on vibration severity (and provided that an ISO standard was selected), the display shows a green, yellow or red condition indicator.

When an external sensor is used, the instrument displays the bias voltage level for the current reading in the upper part of the display. If the reading was made with a poor sensor line, the instrument will display Bias error (D). For further information about bias problems, please see the "*Bias voltage*" section.

To return to the **Main display**, press the **BACK** key.

For information on how to store and analyze measurement results, see sections '*Storing measurement results*' and '*Spectrum analysis*', respectively.

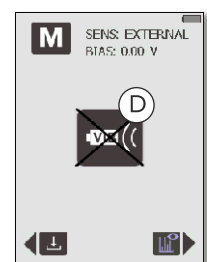
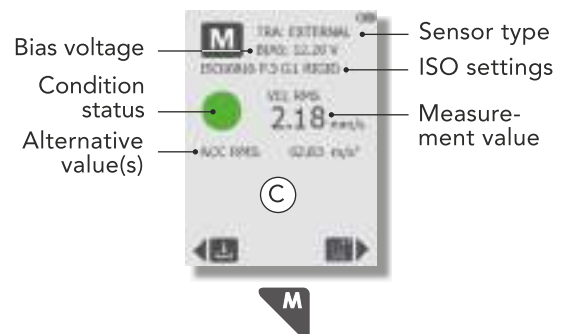
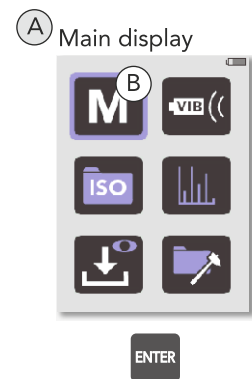

## Built-in sensor with probe

Measuring points for the built-in probe should be clearly marked. Always measure in the same spot.

The probe tip is spring loaded and moves within a sleeve of hard rubber. To maintain a steady pressure on the tip, press the probe tip against the measuring point until the rubber sleeve is in contact with the surface.

Hold the probe steady to avoid rubbing between the probe tip and the machine surface.

The probe is directionally sensitive. The centre of the probe tip should touch the surface. Avoid pressing the probe tip against cavities and fillets which are smaller than the probe tip.

The only part likely to wear out is the rubber sleeve for the probe tip. It is made of chloroprene rubber and tolerates 110° C (230° F). Spare sleeves have part number 18128.

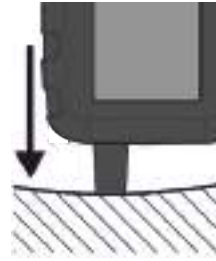

Rubber sleeve in contact with the surface. Hold steady.

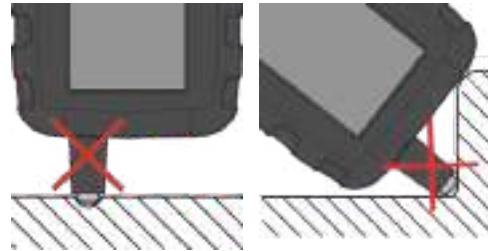

Avoid small cavities and fillets.

## Measuring points

Vibration severity is primarily a measure for general machine condition. Vibration at the measuring point should be representative for the overall vibration of the machine. Typical measuring points are on the bearing housings. By measuring in three directions, one can get an indication of the causes for increased vibration.

- Horizontal vibration (H) in the plane of rotation is most representative of balance condition.
- Vertical vibration (V) in the plane of rotation is most representative of structural weakness.
- Axial vibration (A) along the line of the shaft is most representative of faulty alignment and bent shafts.

To get comparable results, the measuring points should be clearly marked, so that measurements can always be taken in the same spots.

The firmer the contact with the machine, the better the measuring result. Plain, clean metal makes the best contact surface for the vibration sensor.

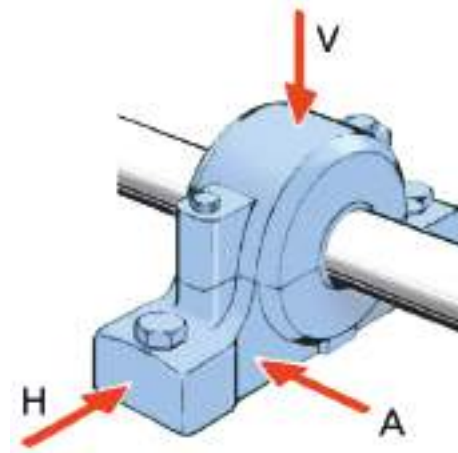



# M Measurement

For all VibChecker versions, measurement is started manually from the **Measurement** display, which is opened by pressing the **MEASURE** key from anywhere in the menu structure.

If the instrument is on and the backlight is off, nothing happens at first keypress, except that the backlight comes on. Next keypress will perform the intended action.

Before measurement, make sure that ISO standard, sensor settings, units etc. are set up.

To perform a vibration measurement:

1. In the **Main display** (A), select the **Measure** icon (B) and press **ENTER**. The **Measurement** display opens, showing the most recent reading.
2. For a new measurement, point the VibChecker straight at the measuring point and press the probe tip until the rubber sleeve is in contact with the surface (or connect the external sensor).
3. Hold the instrument steady and press the **MEASURE** key to start measurement. A single blue pixel briefly appears at the bottom of the display, indicating that a measurement cycle - beginning with an automatic bias check - is in progress. The display backlight is then turned off until the measurement is completed.

When using an external sensor, the actual measuring starts when the defined settling time has elapsed. As long as the **Measurement** display is still selected and the backlight is on, no new settling time is needed to make further measurements, unless you switch to using the built-in measuring probe.

4. When the display lights up again, it shows the measurement result according to the settings made in the instrument (C). The result is shown in large numbers, with alternative values (RMS, peak, and peak-to-peak, depending on the selected vibration quantity) shown in small numbers below. Depending on vibration severity (and provided that an ISO standard was selected), the display shows a green, yellow or red condition indicator.

When an external sensor is used, the instrument displays the bias voltage level for the current reading in the upper part of the display. If the reading was made with a poor sensor line, the instrument will display Bias error (D). For further information about bias problems, please see the "*Bias voltage*" section.

To return to the **Main display**, press the **BACK** key.

For information on how to store and analyze measurement results, see sections '*Storing measurement results*' and '*Spectrum analysis*', respectively.

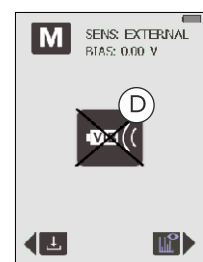
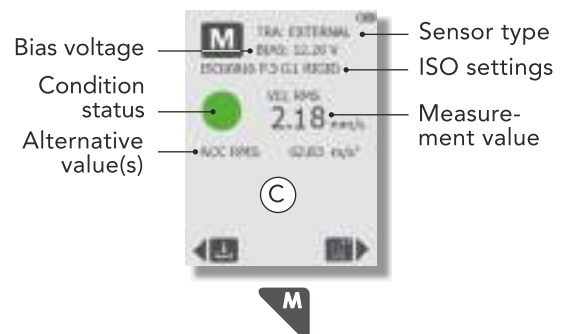
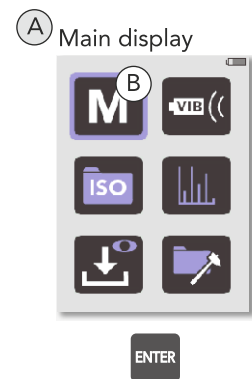

## Overrange warning

If a measurement is made that exceeds the instrument's measuring range, VibChecker will indicate an 'Over-range' error and the reading will not be accepted.

## Recording readings for follow-up

The VibChecker follow-up form provides space for readings in all three directions at up to four different measuring points, which should adequately cover most industrial machines. Experience will soon show which of the measuring points and directions provide the most useful information for diagnosing a specific problem on any particular piece of machinery.

A graph is the best way to show clearly all significant changes of the vibration level. To keep the form simple, draw only the graph for the most significant direction, normally the one giving the highest readings.

Follow-up forms for copying are found on the last pages in this manual.

VibChecker  
follow-up form

The image shows a screenshot of a software interface for recording vibration data. It features a grid with four rows, each representing a different measuring point. Each row contains a series of colored bars (green, yellow, orange, red) that represent the vibration level at that point. The grid is set against a background of a fine grid. The interface also includes some text fields and a small window in the top right corner.



## Storing measurement results

Using the **Save** function to store measurement results is useful for easy comparison of readings from different points in time, thus making it possible to see the development of the condition for individual measuring points. VibChecker can store up to ten vibration measurement results along with date/time, ISO settings and spectrum.

### Saving a reading

To save a reading after completed measurement:

1. In the **Measurement** display (A), press the **LEFT** arrow key to enter the **Save** function (B).
2. Use the arrow keys to select a memory location (1-10).
3. Press the **ENTER** key to store the reading. This action will overwrite any previously stored value in the memory address selected. A checkmark symbol (C) confirms the save operation, and the current memory location turns the same color as the condition evaluation of the reading just saved.
4. To return to the **Measurement** display, press the **BACK** key.

The stored measurement results (excluding spectrum) can be transferred from VibChecker to a Microsoft Excel file using a downloadable SPM program (<http://downloads.spminstrument.com>). The data in the Excel file can be imported into a CMMS or other software for follow-up. For further instructions, please see information in the delivery package.

As an alternative, the final pages of this User Guide contains a follow-up form which can be copied and used to manually record measurement results over time.

### Viewing a stored reading

To view a stored reading:

1. In the **Main** display, select the **View stored readings** icon (D) and press **ENTER**.
2. In the **View stored readings** display (E), use the arrow keys to highlight a memory location.
3. Press the **ENTER** key to view the stored reading (F).

To return to the **View stored readings** display, press the **BACK** key.

### Deleting stored readings

To delete the stored readings:

1. In the **Main** display, select the **View stored readings** icon (D) and press **ENTER**.
2. In the **View stored readings** display (E), use the arrow keys to highlight the trash can (G).
3. Press the **ENTER** key to delete all of the stored readings.

To return to the **View stored readings** display, press the **BACK** key.



# Spectrum analysis

The purpose of a spectrum is to reveal line patterns associated with machine faults. VibChecker generates an FFT spectrum for pattern recognition.

## Spectrum display

To view a spectrum:

1. In the **Measurement** display (A), press the **RIGHT** arrow key.
2. In the display shown next (B), use the **UP/DOWN** arrow keys to highlight the 'Spectrum' checkbox and press **ENTER**.

The **Spectrum** display (C) shows a bar-type spectrum with the resolution set up in the **Spectrum** display (see the '*Spectrum resolution settings*' section), compressed to screen resolution for full view. The spectrum is zoomable; see below.

## Zoom

The zoom functionality works as follows:

- To zoom in, use the **UP** arrow key. Please be observant that the Y scale will change, adapting to the zoomed-in view.
- To zoom out, use the **DOWN** arrow key.
- To move the zoom window along the X axis, use the **LEFT/RIGHT** arrow keys.

The upper part of the **Zoom** display shows the RMS value and frequency of the spectrum line in the centre of the display, marked with a red cursor.

To return to the **Measurement** display, press the **BACK** key twice.

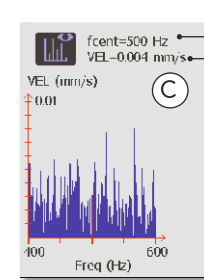
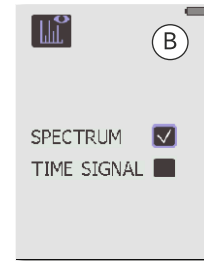

Center frequency  
RMS value

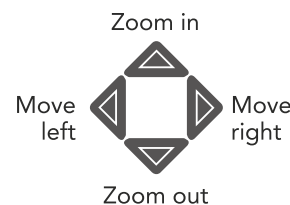

# ISO 2372

Vibration severity measurement according to ISO 2372 is a broad band measurement over the frequency range 10 to 1000 Hz. It returns the RMS value of vibration velocity in mm/s (or inch/s). This value is representative of the energy contents of machine vibration, and thus of the destructive forces acting on the machine. It is widely regarded as a good and easy to obtain indicator of general machine condition.

| RMS<br>mm/s | ISO2372 |        |        |        |        |        | RMS<br>in/s |
|-------------|---------|--------|--------|--------|--------|--------|-------------|
|             | I       | II     | III    | IV     | V      | VI     |             |
| 71          | Red     | Red    | Red    | Red    | Red    | Red    | 2.80        |
| 45          | Red     | Red    | Red    | Red    | Red    | Red    | 1.77        |
| 28          | Red     | Red    | Red    | Red    | Yellow | Yellow | 1.10        |
| 18          | Red     | Red    | Red    | Yellow | Yellow | Green  | 0.71        |
| 11          | Red     | Red    | Yellow | Yellow | Green  | Green  | 0.44        |
| 7.1         | Red     | Yellow | Yellow | Green  | Green  | Green  | 0.28        |
| 4.5         | Yellow  | Yellow | Green  | Green  | Green  | Green  | 0.18        |
| 2.8         | Yellow  | Green  | Green  | Green  | Green  | Green  | 0.11        |
| 1.8         | Green   | Green  | Green  | Green  | Green  | Green  | 0.071       |
| 1.1         | Green   | Green  | Green  | Green  | Green  | Green  | 0.044       |
| 0.71        | Green   | Green  | Green  | Green  | Green  | Green  | 0.028       |
| 0.45        | Green   | Green  | Green  | Green  | Green  | Green  | 0.018       |
| 0.28        | Green   | Green  | Green  | Green  | Green  | Green  | 0.011       |

## Evaluation of machine condition

The evaluation consists of a comparison of the measured value with the ISO limit values recommended for 6 different classes (see definition on the next page).

The majority of industrial machinery belongs to the vibration classes 2, 3, and 4:

Class II: Medium size machines without special supports

Class III: Large size machines on rigid supports

Class IV: Turbomachines and large machines on flexible supports

For example, most smaller process pumps in a chemical plant would be Class 2. A 100 kW fan on a concrete foundation would be Class 3. However, the same fan fastened to the less rigid metal deck of a ship could be considered as Class 4.

Class 1 refers to independent parts of machines, for example electric motors up to 15 kW. Classes 5 and 6 are used for heavy reciprocating prime movers and machines which are intended to vibrate, such as vibrating screens.

VibChecker is programmed with the ISO limit values and will evaluate the measuring result, provided the ISO machine class number is input in the **ISO setup** display. On the instrument, a green condition indicator will be shown for good and acceptable ISO values, a yellow indicator for just tolerable, and a red one in cases of unacceptable values.

# Definition of machine classes according to ISO 2372

The following text is a quotation from ISO 2372 (1974, E, page 6, Annex A). This ISO recommendation has also been published as British Standard (BS 4675, part I). A similar vibration classification of industrial machinery can be found in VDI 2056.

In order to show how the recommended method of classification may be applied, examples of specific classes of machines are given below. It should be emphasized, however, that they are simply examples and it is recognized that other classifications are possible and may be substituted in accordance with the circumstances concerned. As and when circumstances permit, recommendations for acceptable levels of vibration severity for particular types of machines will be prepared. At present, experience suggests that the following classes are appropriate for most applications.

## Class I

Individual parts of engines and machines, integrally connected with the complete machine in its normal operating condition. (Production electrical motors of up to 15 kW are typical examples of machines in this category.)

## Class II

Medium-sized machines, (typically electrical motors with 15 to 75 kW output) without special foundations, rigidly mounted engines or machines (up to 300 kW) on special foundations.

## Class III

Large prime movers and other large machines with rotating masses on rigid and heavy foundations which are relatively stiff in the direction of vibration measurement.

## Class IV

Large prime movers and other large machines with rotating masses on foundations which are relatively soft in the direction of vibration measurement (for example turbogenerator sets, especially those with lightweight substructures).

## Class V

Machines and mechanical drive systems with unbalanceable inertia effects (due to reciprocating parts), mounted on foundations which are relatively stiff in the direction of vibration measurement.

## Class VI

Machines and mechanical drive systems with unbalanceable inertia effects (due to reciprocating parts), mounted on foundations which are relatively soft in the direction of vibration measurements; machines with rotating slack coupled masses such as beater shafts in grinding mills; machines, like centrifugal machines, with varying unbalances capable of operating as self-contained units without connecting components; vibrating screens, dynamic fatigue-testing machines and vibration exciters used in processing plants.

# ISO 10816

ISO 10816 consists of several parts, each stating measurement conditions and a table of limit values for a defined machine type. Like ISO 2372, the evaluation of machine condition is based on the RMS values obtained by broadband measurement over a frequency range up to 1000 Hz. Machine condition evaluation according to the ISO 10816 standard requires a correct classification of the monitored machine. VibChecker covers ISO 10816 Parts 2, 3, and 4 > 600 RPM.

## ISO 10816 Part 2

In case the machine you want to monitor is a 'large land-based steam turbine generator set in excess of 50 MW', part 2 is your obvious choice.

This machine class has no sub group. Instead, the choice of limit value table depends on machine speed, either '1500/1800 r/min' or '3000/3600 r/min'.

Selecting the appropriate speed range results in a measurement setup with the ISO recommended frequency range (10 to 500 Hz), the recommended measurement quantity (vibration velocity = VEL) and the limit values or 'zone boundaries'.

A measurement result below the zone boundary of 5.3 mm/s RMS is acceptable and will be marked green. Results from 5.3 mm/s to below 8,5 mm/s will be marked yellow, and 8.5 mm/s or higher will be red.

Evaluation zone boundaries based on bearing housing/pedestal vibration velocity.

| Condition      | Shaft rotational speed |      |                 |      |
|----------------|------------------------|------|-----------------|------|
|                | 1500 / 1800 RPM        |      | 3000 / 3600 RPM |      |
|                | Vibration velocity VEL |      |                 |      |
| Zone boundary  | mm/s                   | in/s | mm/s            | in/s |
| Green / Yellow | 5.3                    | 0.20 | 7.5             | 0.30 |
| Yellow / Red   | 8.5                    | 0.33 | 11.8            | 0.46 |

## ISO 10816 Part 3

Part 3 treats most of the common industrial machines and is divided into four groups. Further criteria for Part 3 are the rigidity of the foundation and the rotational speed. Concrete foundations are rigid, everything else falls under flexible. The RPM affects the lower measuring range as well as the limit values.

### Group 1

Evaluation zone boundaries for machines of Group 1: Large machines with rated power above 300 kW and not more than 50 MW; electrical machines with shaft height  $H \geq 315$  mm.

| Support class | Condition<br>Zone boundary | DISP                              |      | VEL                  |      |
|---------------|----------------------------|-----------------------------------|------|----------------------|------|
|               |                            | RMS displacement<br>$\mu\text{m}$ | mils | RMS velocity<br>mm/s | in/s |
| Rigid         | Green / Yellow             | 57                                | 2.24 | 4.5                  | 0.18 |
|               | Yellow / Red               | 90                                | 3.54 | 7.1                  | 0.28 |
| Flexible      | Green / Yellow             | 90                                | 3.54 | 7.1                  | 0.28 |
|               | Yellow / Red               | 140                               | 5.51 | 11.0                 | 0.43 |

### Group 2

Evaluation zone boundaries for machines of Group 2: Medium-size machines with rated power above 15 kW up to and including 300 kW; electrical machines with shaft height  $160 \text{ mm} \leq H < 315$  mm.

| Support class | Condition<br>Zone boundary | DISP                              |      | VEL                  |      |
|---------------|----------------------------|-----------------------------------|------|----------------------|------|
|               |                            | RMS displacement<br>$\mu\text{m}$ | mils | RMS velocity<br>mm/s | in/s |
| Rigid         | Green / Yellow             | 45                                | 1.77 | 2.8                  | 0.08 |
|               | Yellow / Red               | 71                                | 2.80 | 4.5                  | 0.18 |
| Flexible      | Green / Yellow             | 71                                | 2.80 | 4.5                  | 0.18 |
|               | Yellow / Red               | 113                               | 4.45 | 7.1                  | 0.28 |

### Group 3

Evaluation zone boundaries for machines of Group 3: Pumps with multivane impeller and with separate driver (centrifugal, mixed flow or axial flow) with rated power above 15 kW.

| Support class | Condition<br>Zone boundary | DISP                              |      | VEL                  |      |
|---------------|----------------------------|-----------------------------------|------|----------------------|------|
|               |                            | RMS displacement<br>$\mu\text{m}$ | mils | RMS velocity<br>mm/s | in/s |
| Rigid         | Green / Yellow             | 36                                | 1.42 | 4.5                  | 0.18 |
|               | Yellow / Red               | 56                                | 2.20 | 7.1                  | 0.28 |
| Flexible      | Green / Yellow             | 56                                | 2.20 | 7.1                  | 0.28 |
|               | Yellow / Red               | 90                                | 3.54 | 11.0                 | 0.43 |

### Group 4

Evaluation zone boundaries for machines of Group 4: Pumps with multivane impeller and with integrated driver (centrifugal, mixed flow or axial flow) with rated power above 15 kW.

| Support class | Condition<br>Zone boundary | DISP                              |      | VEL                  |      |
|---------------|----------------------------|-----------------------------------|------|----------------------|------|
|               |                            | RMS displacement<br>$\mu\text{m}$ | mils | RMS velocity<br>mm/s | in/s |
| Rigid         | Green / Yellow             | 22                                | 0.87 | 2.8                  | 0.08 |
|               | Yellow / Red               | 36                                | 1.42 | 4.5                  | 0.18 |
| Flexible      | Green / Yellow             | 36                                | 1.42 | 4.5                  | 0.18 |
|               | Yellow / Red               | 56                                | 2.20 | 7.1                  | 0.28 |

## ISO 10816 Part 4

Part 4 is limited to 'Gas turbine driven sets excluding aircraft derivatives'. The standard also states a power output of at least 3 MW.

Evaluation zone boundaries based on bearing housing/pedestal vibration velocity, valid for shaft rotational speed 3000 RPM to 20 000 RPM.

| Condition<br>Zone boundary | Vibration velocity VEL |      |
|----------------------------|------------------------|------|
|                            | mm/s                   | in/s |
| Green / Yellow             | 9.3                    | 0.37 |
| Yellow / Red               | 14.7                   | 0.58 |

Note: These values, which are the upper limits of the zones, should apply to radial vibration measurements on all bearing housings or pedestals and to axial vibration measurements on housings containing an axial thrust bearing, under steady-state operating conditions at rated speed.



# Technical specifications

## VibChecker VC200/250

|   |   |
|---|---|
| Frequency range:  | 10 to 1000 Hz   |
| Readings:   | RMS / peak / peak-to-peak   |
| Measuring range, (sinus signal and 100 mV/g accelerometer): |   |
| Velocity RMS  | 100 mm/s (4 ips) at 80 Hz   |
| Acceleration RMS  | 100 m/s <sup>2</sup> (10 g) at 10-1000 Hz   |
| Displacement RMS  | 100 um (4 mil) at 80 Hz   |
| Condition evaluation:                                       | according to ISO2372 and ISO10816 Part 2, 3, 4 >600 RPM   |
| Spectrum:   | linear, 200/400/800 lines, Hanning window, Hz/cpm, zoom, RPM markers  |
| Time signal:  | 512/1024/2048 samples, zoom, marker   |
| General functions:  | battery status, bias check, metric or imperial units, language independent menus, storage of up to 10 measuring samples |
| Condition indication:                                       | green, yellow and red symbols   |
| Display:  | 2.4" Color TFT LCD display, LED backlight   |
| Keypad:   | sealed, snap action   |
| Material, casing:   | copolyester/TPE   |
| Power supply:   | 3.63 V Lithium Ion, USB rechargeable  |
| Battery life:   | > 25 hours of typical use   |
| Built-in sensor:  | accelerometer type MEMS   |
| Input connector:  | mini coax, for external sensor  |
| External sensors:   | vibration transducer TRM100/ TRM120 or IEPE (ICP®) type transducers with voltage output                                 |
| Output connector:   | mini-B USB  |
| Operating temperature:                                      | -10 °C to +50 °C (14 °F to 122 °F)  |
| Dimensions:   | VC200: 207x74x41 mm (8.1x2.9x1.6 in)<br>VC250: 184x74x41 mm (7.2x2.9x1.6 in)  |
| Weight:   | VC200: 335 g (11.8 ounces)<br>VC250: 300 g (10.6 ounces)  |

## Accessories

|        |   |
|--------|---|
| TRM100 | External sensor with integral magnet, straight, 1.5 m |
| TRM120 | External sensor with integral magnet, angled, 1.5 m   |
| 93363  | Cable adapter, mini coax - BNC                        |
| 93062  | Cable adapter, BNC - TNC, plug-jack                   |
| CAB52  | Measuring cable, 1.5 m, mini coax- BNC slip-on        |



TRM100



TRM120

## Spare parts

|       |   |
|-------|---|
| 18128 | Rubber sleeve for probe tip, chloroprene, maximum 110 °C (230 °F) |
|-------|---|



# Maintenance and calibration

## Maintenance

If needed, use a soft cloth lightly dampened with a mild detergent to clean the display. Avoid abrasive cleaners or solvents that may damage the display.

## Calibration

An instrument calibration, e.g. for the purpose of compliance with ISO quality standard requirements, is recommended once a year. Please contact your SPM representative for service, software upgrade or calibration. If a calibration date is stated, this date can be seen in the **Date and time** display (A) under **General settings**.

## Calibration reminder

The calibration reminder (B) will be shown at switch-on when the VibChecker has been in use for the recommended period and is to be sent to an authorized SPM service establishment in your local area. As a further reminder, a small envelope icon will be displayed in the upper right corner of the **Main** display.

Date and time

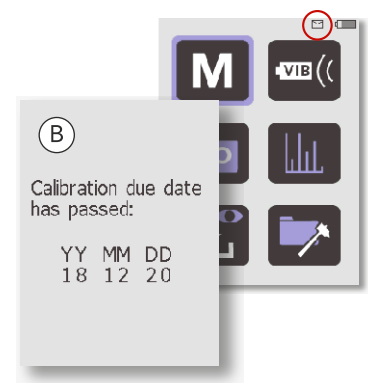

## Warranty

One (1) year limited warranty from date of purchase against defects in workmanship or materials. Warranty is void if instrument is altered or repaired by unauthorized service center, or if warranty seal is broken. Warranty does not apply on any instrument subjected to misuse or damaged by leaking batteries. Warranty is for instrument only and does not cover batteries or cables. SPM reserves the right to determine disposition as to repair or replacement of goods.

Should the instrument require any service whether under warranty or not, you should contact SPM Instrument or your local distributor for instructions before returning the goods.

## EU Directive on waste electrical and electronic equipment

WEEE is EU Directive 2002/96/EC of the European Parliament and of the Council on waste electrical and electronic equipment.

The purpose of this directive is, as a first priority, the prevention of waste electrical and electronic equipment (WEEE), and in addition, the reuse, recycling and other forms of recovery of such wastes so as to reduce the disposal of waste.

This product must be disposed of as electronic waste and is marked with a crossed-out wheeled bin symbol in order to prevent it being discarded with household waste.

Once the life cycle of the product is over you can return it to your local SPM representative for correct treatment, or dispose of it together with your other electronic waste.





# Technical specifications

## VibChecker VC200/250

|   |   |
|---|---|
| Frequency range:  | 10 to 1000 Hz   |
| Readings:   | RMS / peak / peak-to-peak   |
| Measuring range, (sinus signal and 100 mV/g accelerometer): |   |
| Velocity RMS  | 100 mm/s (4 ips) at 80 Hz   |
| Acceleration RMS  | 100 m/s <sup>2</sup> (10 g) at 10-1000 Hz   |
| Displacement RMS  | 100 um (4 mil) at 80 Hz   |
| Condition evaluation:                                       | according to ISO2372 and ISO10816 Part 2, 3, 4 >600 RPM   |
| Spectrum:   | linear, 200/400/800 lines, Hanning window, Hz/cpm, zoom, RPM markers  |
| Time signal:  | 512/1024/2048 samples, zoom, marker   |
| General functions:  | battery status, bias check, metric or imperial units, language independent menus, storage of up to 10 measuring samples |
| Condition indication:                                       | green, yellow and red symbols   |
| Display:  | 2.4" Color TFT LCD display, LED backlight   |
| Keypad:   | sealed, snap action   |
| Material, casing:   | copolyester/TPE   |
| Power supply:   | 3.63 V Lithium Ion, USB rechargeable  |
| Battery life:   | > 25 hours of typical use   |
| Built-in sensor:  | accelerometer type MEMS   |
| Input connector:  | mini coax, for external sensor  |
| External sensors:   | vibration transducer TRM100/ TRM120 or IEPE (ICP®) type transducers with voltage output                                 |
| Output connector:   | mini-B USB  |
| Operating temperature:                                      | -10 °C to +50 °C (14 °F to 122 °F)  |
| Dimensions:   | VC200: 207x74x41 mm (8.1x2.9x1.6 in)<br>VC250: 184x74x41 mm (7.2x2.9x1.6 in)  |
| Weight:   | VC200: 335 g (11.8 ounces)<br>VC250: 300 g (10.6 ounces)  |

## Accessories

|        |   |
|--------|---|
| TRM100 | External sensor with integral magnet, straight, 1.5 m |
| TRM120 | External sensor with integral magnet, angled, 1.5 m   |
| 93363  | Cable adapter, mini coax - BNC                        |
| 93062  | Cable adapter, BNC - TNC, plug-jack                   |
| CAB52  | Measuring cable, 1.5 m, mini coax- BNC slip-on        |



TRM100



TRM120

## Spare parts

|       |   |
|-------|---|
| 18128 | Rubber sleeve for probe tip, chloroprene, maximum 110 °C (230 °F) |
|-------|---|

# Maintenance and calibration

## Maintenance

If needed, use a soft cloth lightly dampened with a mild detergent to clean the display. Avoid abrasive cleaners or solvents that may damage the display.

## Calibration

An instrument calibration, e.g. for the purpose of compliance with ISO quality standard requirements, is recommended once a year. Please contact your SPM representative for service, software upgrade or calibration. If a calibration date is stated, this date can be seen in the **Date and time** display (A) under **General settings**.

## Calibration reminder

The calibration reminder (B) will be shown at switch-on when the VibChecker has been in use for the recommended period and is to be sent to an authorized SPM service establishment in your local area. As a further reminder, a small envelope icon will be displayed in the upper right corner of the **Main** display.

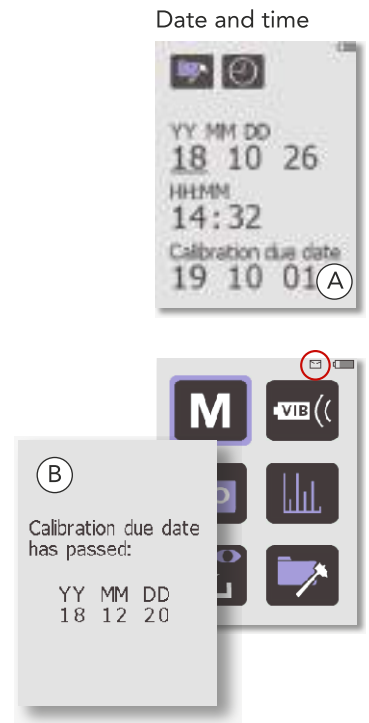

## Warranty

One (1) year limited warranty from date of purchase against defects in workmanship or materials. Warranty is void if instrument is altered or repaired by unauthorized service center, or if warranty seal is broken. Warranty does not apply on any instrument subjected to misuse or damaged by leaking batteries. Warranty is for instrument only and does not cover batteries or cables. SPM reserves the right to determine disposition as to repair or replacement of goods.

Should the instrument require any service whether under warranty or not, you should contact SPM Instrument or your local distributor for instructions before returning the goods.

## EU Directive on waste electrical and electronic equipment

WEEE is EU Directive 2002/96/EC of the European Parliament and of the Council on waste electrical and electronic equipment.

The purpose of this directive is, as a first priority, the prevention of waste electrical and electronic equipment (WEEE), and in addition, the reuse, recycling and other forms of recovery of such wastes so as to reduce the disposal of waste.

This product must be disposed of as electronic waste and is marked with a crossed-out wheeled bin symbol in order to prevent it being discarded with household waste.

Once the life cycle of the product is over you can return it to your local SPM representative for correct treatment, or dispose of it together with your other electronic waste.



Follow-up form, ISO2372, mm/s





VIB|CHECKER ISO2372  
mm/s

.....  
 .....  
 .....  
 .....



| CLASS |     |      | DATE |  |  |  |  |  |  |  |  |  |  |  | CLASS |  |     |     |     |
|-------|-----|------|------|--|--|--|--|--|--|--|--|--|--|--|-------|--|-----|-----|-----|
| I     | II  | III  |      |  |  |  |  |  |  |  |  |  |  |  |       |  | IV  | V   | VI  |
| 11    | 18  | 28   |      |  |  |  |  |  |  |  |  |  |  |  |       |  | 45  | 71  | 110 |
| 7.1   | 11  | 18   |      |  |  |  |  |  |  |  |  |  |  |  |       |  | 28  | 45  | 71  |
| 4.5   | 7.1 | 11   |      |  |  |  |  |  |  |  |  |  |  |  |       |  | 18  | 28  | 45  |
| 2.8   | 4.5 | 7.1  |      |  |  |  |  |  |  |  |  |  |  |  |       |  | 11  | 18  | 28  |
| 1.8   | 2.8 | 4.5  |      |  |  |  |  |  |  |  |  |  |  |  |       |  | 7.1 | 11  | 18  |
| 1.1   | 1.8 | 2.8  |      |  |  |  |  |  |  |  |  |  |  |  |       |  | 4.5 | 7.1 | 11  |
| 0.7   | 1.1 | 1.8  |      |  |  |  |  |  |  |  |  |  |  |  |       |  | 2.8 | 4.5 | 7.1 |
| 0.5   | 0.7 | 1.15 |      |  |  |  |  |  |  |  |  |  |  |  |       |  | 1.8 | 2.8 | 4.5 |
| 0.3   | 0.5 | 0.7  |      |  |  |  |  |  |  |  |  |  |  |  |       |  | 1.1 | 1.8 | 2.8 |
| 1     | H   |      |      |  |  |  |  |  |  |  |  |  |  |  |       |  |     |     |     |
|       | V   |      |      |  |  |  |  |  |  |  |  |  |  |  |       |  |     |     |     |
|       | A   |      |      |  |  |  |  |  |  |  |  |  |  |  |       |  |     |     |     |
| 11    | 18  | 28   |      |  |  |  |  |  |  |  |  |  |  |  |       |  | 45  | 71  | 110 |
| 7.1   | 11  | 18   |      |  |  |  |  |  |  |  |  |  |  |  |       |  | 28  | 45  | 71  |
| 4.5   | 7.1 | 11   |      |  |  |  |  |  |  |  |  |  |  |  |       |  | 18  | 28  | 45  |
| 2.8   | 4.5 | 7.1  |      |  |  |  |  |  |  |  |  |  |  |  |       |  | 11  | 18  | 28  |
| 1.8   | 2.8 | 4.5  |      |  |  |  |  |  |  |  |  |  |  |  |       |  | 7.1 | 11  | 18  |
| 1.1   | 1.8 | 2.8  |      |  |  |  |  |  |  |  |  |  |  |  |       |  | 4.5 | 7.1 | 11  |
| 0.7   | 1.1 | 1.8  |      |  |  |  |  |  |  |  |  |  |  |  |       |  | 2.8 | 4.5 | 7.1 |
| 0.5   | 0.7 | 1.15 |      |  |  |  |  |  |  |  |  |  |  |  |       |  | 1.8 | 2.8 | 4.5 |
| 0.3   | 0.5 | 0.7  |      |  |  |  |  |  |  |  |  |  |  |  |       |  | 1.1 | 1.8 | 2.8 |
| 2     | H   |      |      |  |  |  |  |  |  |  |  |  |  |  |       |  |     |     |     |
|       | V   |      |      |  |  |  |  |  |  |  |  |  |  |  |       |  |     |     |     |
|       | A   |      |      |  |  |  |  |  |  |  |  |  |  |  |       |  |     |     |     |
| 11    | 18  | 28   |      |  |  |  |  |  |  |  |  |  |  |  |       |  | 45  | 71  | 110 |
| 7.1   | 11  | 18   |      |  |  |  |  |  |  |  |  |  |  |  |       |  | 28  | 45  | 71  |
| 4.5   | 7.1 | 11   |      |  |  |  |  |  |  |  |  |  |  |  |       |  | 18  | 28  | 45  |
| 2.8   | 4.5 | 7.1  |      |  |  |  |  |  |  |  |  |  |  |  |       |  | 11  | 18  | 28  |
| 1.8   | 2.8 | 4.5  |      |  |  |  |  |  |  |  |  |  |  |  |       |  | 7.1 | 11  | 18  |
| 1.1   | 1.8 | 2.8  |      |  |  |  |  |  |  |  |  |  |  |  |       |  | 4.5 | 7.1 | 11  |
| 0.7   | 1.1 | 1.8  |      |  |  |  |  |  |  |  |  |  |  |  |       |  | 2.8 | 4.5 | 7.1 |
| 0.5   | 0.7 | 1.15 |      |  |  |  |  |  |  |  |  |  |  |  |       |  | 1.8 | 2.8 | 4.5 |
| 0.3   | 0.5 | 0.7  |      |  |  |  |  |  |  |  |  |  |  |  |       |  | 1.1 | 1.8 | 2.8 |
| 3     | H   |      |      |  |  |  |  |  |  |  |  |  |  |  |       |  |     |     |     |
|       | V   |      |      |  |  |  |  |  |  |  |  |  |  |  |       |  |     |     |     |
|       | A   |      |      |  |  |  |  |  |  |  |  |  |  |  |       |  |     |     |     |
| 11    | 18  | 28   |      |  |  |  |  |  |  |  |  |  |  |  |       |  | 45  | 71  | 110 |
| 7.1   | 11  | 18   |      |  |  |  |  |  |  |  |  |  |  |  |       |  | 28  | 45  | 71  |
| 4.5   | 7.1 | 11   |      |  |  |  |  |  |  |  |  |  |  |  |       |  | 18  | 28  | 45  |
| 2.8   | 4.5 | 7.1  |      |  |  |  |  |  |  |  |  |  |  |  |       |  | 11  | 18  | 28  |
| 1.8   | 2.8 | 4.5  |      |  |  |  |  |  |  |  |  |  |  |  |       |  | 7.1 | 11  | 18  |
| 1.1   | 1.8 | 2.8  |      |  |  |  |  |  |  |  |  |  |  |  |       |  | 4.5 | 7.1 | 11  |
| 0.7   | 1.1 | 1.8  |      |  |  |  |  |  |  |  |  |  |  |  |       |  | 2.8 | 4.5 | 7.1 |
| 0.5   | 0.7 | 1.15 |      |  |  |  |  |  |  |  |  |  |  |  |       |  | 1.8 | 2.8 | 4.5 |
| 0.3   | 0.5 | 0.7  |      |  |  |  |  |  |  |  |  |  |  |  |       |  | 1.1 | 1.8 | 2.8 |
| 4     | H   |      |      |  |  |  |  |  |  |  |  |  |  |  |       |  |     |     |     |
|       | V   |      |      |  |  |  |  |  |  |  |  |  |  |  |       |  |     |     |     |
|       | A   |      |      |  |  |  |  |  |  |  |  |  |  |  |       |  |     |     |     |

Follow-up form, ISO2372, inch/s

|   |  |   |
|---|--|---|
|  |  | <b>VIB CHECKER ISO2372</b><br>inch/s  |
|   |  | .....<br>.....<br>.....<br>.....  |
|   |  |  |

| CLASS |      |      | DATE |      |      |  |  |  |  |  |  |  |  |  | CLASS |      |      |    |   |    |
|-------|------|------|------|------|------|--|--|--|--|--|--|--|--|--|-------|------|------|----|---|----|
| I     | II   | III  |      |      |      |  |  |  |  |  |  |  |  |  |       |      |      | IV | V | VI |
| 0.43  | 0.71 | 1.10 |      |      |      |  |  |  |  |  |  |  |  |  | 1.77  | 2.80 | 4.30 |    |   |    |
| 0.28  | 0.43 | 0.71 |      |      |      |  |  |  |  |  |  |  |  |  | 1.10  | 1.77 | 2.80 |    |   |    |
| 0.18  | 0.28 | 0.43 |      |      |      |  |  |  |  |  |  |  |  |  | 0.71  | 1.10 | 1.77 |    |   |    |
| 0.11  | 0.18 | 0.28 |      |      |      |  |  |  |  |  |  |  |  |  | 0.43  | 0.71 | 1.10 |    |   |    |
| 0.07  | 0.11 | 0.18 |      |      |      |  |  |  |  |  |  |  |  |  | 0.28  | 0.43 | 0.71 |    |   |    |
| 0.04  | 0.07 | 0.11 |      |      |      |  |  |  |  |  |  |  |  |  | 0.18  | 0.28 | 0.43 |    |   |    |
| 0.03  | 0.04 | 0.07 |      |      |      |  |  |  |  |  |  |  |  |  | 0.11  | 0.18 | 0.28 |    |   |    |
| 0.02  | 0.03 | 0.04 |      |      |      |  |  |  |  |  |  |  |  |  | 0.07  | 0.11 | 0.18 |    |   |    |
| 0.01  | 0.02 | 0.03 | 0.04 | 0.07 | 0.11 |  |  |  |  |  |  |  |  |  |       |      |      |    |   |    |
| 1     | H    |      |      |      |      |  |  |  |  |  |  |  |  |  |       |      |      |    |   |    |
|       | V    |      |      |      |      |  |  |  |  |  |  |  |  |  |       |      |      |    |   |    |
|       | A    |      |      |      |      |  |  |  |  |  |  |  |  |  |       |      |      |    |   |    |
| 0.43  | 0.71 | 1.10 |      |      |      |  |  |  |  |  |  |  |  |  | 1.77  | 2.80 | 4.30 |    |   |    |
| 0.28  | 0.43 | 0.71 |      |      |      |  |  |  |  |  |  |  |  |  | 1.10  | 1.77 | 2.80 |    |   |    |
| 0.18  | 0.28 | 0.43 |      |      |      |  |  |  |  |  |  |  |  |  | 0.71  | 1.10 | 1.77 |    |   |    |
| 0.11  | 0.18 | 0.28 |      |      |      |  |  |  |  |  |  |  |  |  | 0.43  | 0.71 | 1.10 |    |   |    |
| 0.07  | 0.11 | 0.18 |      |      |      |  |  |  |  |  |  |  |  |  | 0.28  | 0.43 | 0.71 |    |   |    |
| 0.04  | 0.07 | 0.11 |      |      |      |  |  |  |  |  |  |  |  |  | 0.18  | 0.28 | 0.43 |    |   |    |
| 0.03  | 0.04 | 0.07 |      |      |      |  |  |  |  |  |  |  |  |  | 0.11  | 0.18 | 0.28 |    |   |    |
| 0.02  | 0.03 | 0.04 |      |      |      |  |  |  |  |  |  |  |  |  | 0.07  | 0.11 | 0.18 |    |   |    |
| 0.01  | 0.02 | 0.03 | 0.04 | 0.07 | 0.11 |  |  |  |  |  |  |  |  |  |       |      |      |    |   |    |
| 2     | H    |      |      |      |      |  |  |  |  |  |  |  |  |  |       |      |      |    |   |    |
|       | V    |      |      |      |      |  |  |  |  |  |  |  |  |  |       |      |      |    |   |    |
|       | A    |      |      |      |      |  |  |  |  |  |  |  |  |  |       |      |      |    |   |    |
| 0.43  | 0.71 | 1.10 |      |      |      |  |  |  |  |  |  |  |  |  | 1.77  | 2.80 | 4.30 |    |   |    |
| 0.28  | 0.43 | 0.71 |      |      |      |  |  |  |  |  |  |  |  |  | 1.10  | 1.77 | 2.80 |    |   |    |
| 0.18  | 0.28 | 0.43 |      |      |      |  |  |  |  |  |  |  |  |  | 0.71  | 1.10 | 1.77 |    |   |    |
| 0.11  | 0.18 | 0.28 |      |      |      |  |  |  |  |  |  |  |  |  | 0.43  | 0.71 | 1.10 |    |   |    |
| 0.07  | 0.11 | 0.18 |      |      |      |  |  |  |  |  |  |  |  |  | 0.28  | 0.43 | 0.71 |    |   |    |
| 0.04  | 0.07 | 0.11 |      |      |      |  |  |  |  |  |  |  |  |  | 0.18  | 0.28 | 0.43 |    |   |    |
| 0.03  | 0.04 | 0.07 |      |      |      |  |  |  |  |  |  |  |  |  | 0.11  | 0.18 | 0.28 |    |   |    |
| 0.02  | 0.03 | 0.04 |      |      |      |  |  |  |  |  |  |  |  |  | 0.07  | 0.11 | 0.18 |    |   |    |
| 0.01  | 0.02 | 0.03 | 0.04 | 0.07 | 0.11 |  |  |  |  |  |  |  |  |  |       |      |      |    |   |    |
| 3     | H    |      |      |      |      |  |  |  |  |  |  |  |  |  |       |      |      |    |   |    |
|       | V    |      |      |      |      |  |  |  |  |  |  |  |  |  |       |      |      |    |   |    |
|       | A    |      |      |      |      |  |  |  |  |  |  |  |  |  |       |      |      |    |   |    |
| 0.43  | 0.71 | 1.10 |      |      |      |  |  |  |  |  |  |  |  |  | 1.77  | 2.80 | 4.30 |    |   |    |
| 0.28  | 0.43 | 0.71 |      |      |      |  |  |  |  |  |  |  |  |  | 1.10  | 1.77 | 2.80 |    |   |    |
| 0.18  | 0.28 | 0.43 |      |      |      |  |  |  |  |  |  |  |  |  | 0.71  | 1.10 | 1.77 |    |   |    |
| 0.11  | 0.18 | 0.28 |      |      |      |  |  |  |  |  |  |  |  |  | 0.43  | 0.71 | 1.10 |    |   |    |
| 0.07  | 0.11 | 0.18 |      |      |      |  |  |  |  |  |  |  |  |  | 0.28  | 0.43 | 0.71 |    |   |    |
| 0.04  | 0.07 | 0.11 |      |      |      |  |  |  |  |  |  |  |  |  | 0.18  | 0.28 | 0.43 |    |   |    |
| 0.03  | 0.04 | 0.07 |      |      |      |  |  |  |  |  |  |  |  |  | 0.11  | 0.18 | 0.28 |    |   |    |
| 0.02  | 0.03 | 0.04 |      |      |      |  |  |  |  |  |  |  |  |  | 0.07  | 0.11 | 0.18 |    |   |    |
| 0.01  | 0.02 | 0.03 | 0.04 | 0.07 | 0.11 |  |  |  |  |  |  |  |  |  |       |      |      |    |   |    |
| 4     | H    |      |      |      |      |  |  |  |  |  |  |  |  |  |       |      |      |    |   |    |
|       | V    |      |      |      |      |  |  |  |  |  |  |  |  |  |       |      |      |    |   |    |
|       | A    |      |      |      |      |  |  |  |  |  |  |  |  |  |       |      |      |    |   |    |